

Orientalmotor

Stepper Motors

PKP Series

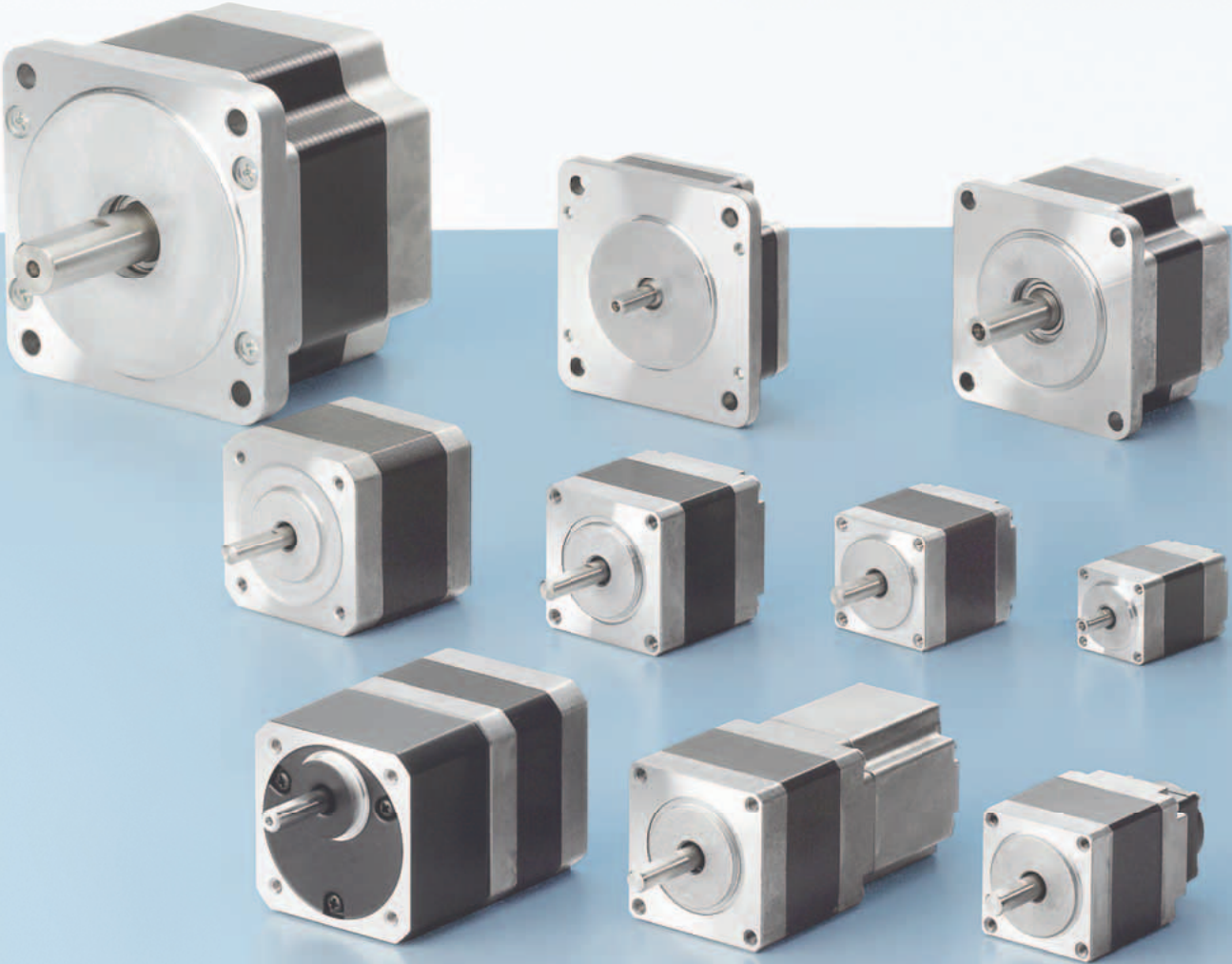

Stepper Motors

PKP Series





Stepper Motors PKP Series

High Torque

Low Vibration

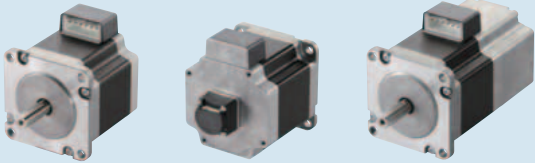
●Bipolar (4 lead wires) and unipolar (5 or 6 lead wires) are available.
(Standard type □50 mm/flat type is bipolar wiring only.)

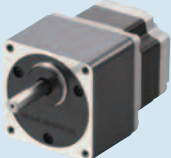
Features/Product Line/System Configuration/Product Number/Product Line/Included Items/Description of Terms in Specification Table			Pages 4~13
Motor Type	Motor Frame Size	Additional Function	Reference Page
Standard Type (Basic step angle: 1.8°/step)  Standard With Encoder With Electromagnetic Brake	□20 mm (0.79 in.)	Standard With Encoder	Pages 14~15
	□28 mm (1.10 in.)	Standard	Pages 16~17
		With Encoder	
		With Electromagnetic Brake	
	□35 mm (1.38 in.)	Standard	Pages 18~19
		With Encoder	
		With Electromagnetic Brake	
	□42 mm (1.65 in.)	Standard	Pages 20~23
		With Encoder	
		With Electromagnetic Brake	
□50 mm* (1.97 in.)	Standard	Page 24	
□56.4 mm (2.22 in.)	Standard	Pages 25~27	
	With Encoder		
	With Electromagnetic Brake		
□85 mm (3.35 in.)	Standard	Pages 28~29	
High-Resolution Type (Basic step angle: 0.9°/step)  Standard With Encoder With Electromagnetic Brake	□42 mm (1.65 in.)	Standard	Pages 30~31
		With Encoder	
		With Electromagnetic Brake	
	□56.4 mm (2.22 in.)	Standard	Pages 32~33
		With Encoder	
		With Electromagnetic Brake	
Flat Type (Basic step angle: 1.8~0.018°/step)  Standard	□42 mm (1.65 in.)	Standard	Page 34
	□60 mm (2.36 in.)	Standard	Page 35
SH Geared Type (Basic step angle: 0.5~0.05°/step)  Standard	□28 mm (1.10 in.)	Standard	Pages 36~41
	□42 mm (1.65 in.)	Standard	
	□60 mm (2.36 in.)	Standard	
General Specifications/Electromagnetic Brake Specifications & Connection/Encoder Specifications/Rotation Direction/Permissible Radial Load & Permissible Axial Load/Inner Wiring Diagram of Motor			Pages 42~44

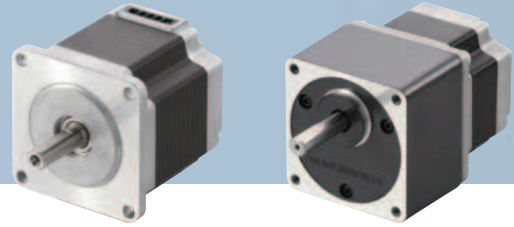

*This is the conventional PK series.



5-Phase Stepper Motors **PKP Series**

High Accuracy

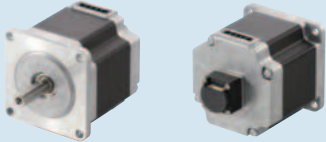
Low Vibration

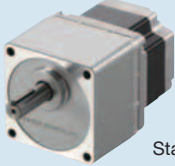
Features/Product Line/System Configuration/Product Number/Product Line/Included Items/Description of Terms in Specification Table			Pages 45~48
Motor Type	Motor Frame Size	Additional Function	Reference Page
Standard Type (Basic step angle: 0.72°/step)  Standard With Encoder	<input type="checkbox"/> 28 mm (1.10 in.)	Standard	Page 49
	<input type="checkbox"/> 42 mm (1.65 in.)	Standard	Pages 50~51
		With Encoder	
	<input type="checkbox"/> 56.4 mm (2.22 in.)	Standard	Pages 52~53
With Encoder			
	<input type="checkbox"/> 60 mm (2.36 in.)	Standard	Pages 54~55
		With Encoder	
High-Resolution Type (Basic step angle: 0.36°/step)  Standard	<input type="checkbox"/> 42 mm (1.65 in.)	Standard	Page 56
	<input type="checkbox"/> 60 mm (2.36 in.)	Standard	Page 57
TS Geared Type (Basic step angle: 0.024~0.2°/step)  Standard	<input type="checkbox"/> 42 mm (1.65 in.)	Standard	Page 58
	<input type="checkbox"/> 60 mm (2.36 in.)	Standard	Page 59
General Specifications/Encoder Specifications/Inner Wiring Diagram of Motor/Rotation Direction/Permissible Radial Load & Permissible Axial Load			Pages 60~61

2-Phase 5-Phase Stepper Motor Drivers

Compact

Low Vibration

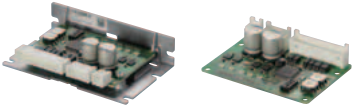
Driver Types and Features		Page 62~63
Bipolar Driver for 2-Phase Stepper Motors Driver for 5-Phase Stepper Motors  With Installation Plate Without Installation Plate		Pages 64~69
Cables		Pages 70~71
Accessories		Pages 72~74

20 mm
(0.79 in.)

28 mm
(1.10 in.)

35 mm
(1.38 in.)

42 mm
(1.65 in.)

50 mm
(1.97 in.)

56.4 mm
(2.22 in.)

60 mm
(2.36 in.)

85 mm
(3.35 in.)

2-Phase Stepper Motors

PKP Series

● For detailed information about regulations and standards, please refer to the Oriental Motor website.

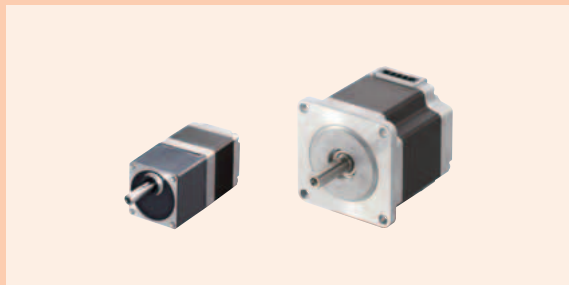

These products are high-torque 2-phase stepper motors. A wide variety of products are available to meet your design specifications.

- Standard Type with a Resolution of 200 Steps per Revolution (Basic step angle: 1.8°/step)
- High-resolution Type with a Resolution of 400 Steps per Revolution (Basic step angle: 0.9°/step)
- **SH** Geared Type for Higher Torque and Higher Resolution.
- Bipolar (4 lead wires) and Unipolar (5 or 6 lead wires) are Available
- Type with Encoder and Type with Electromagnetic Brake are Available
- Many Motor Current Models are Available



See Full Product Details Online
www.orientalmotor.com

● Manual

● Specifications

● Dimensions

● CAD

● Characteristics

● Connection and Operation

Features

Increased Torque over the Entire Speed Range from Low to High

After revising the magnetic and structure design of the **PKP** Series, it produces much more torque than the standard **PK** Series motors of the same size. In addition, torque can be increased in the high-speed range by using high current motors.

Comparison of Speed – Torque Characteristics of the Same Size Motors

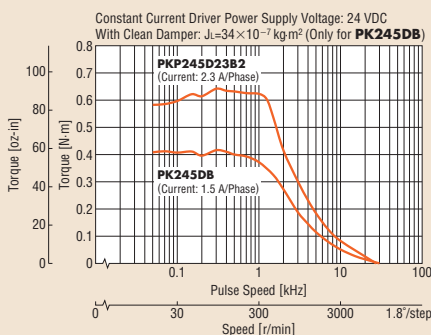

High current is possible due to the revised motor winding design and the highly efficient design of the drive circuit that can be combined. Increased torque over the entire speed range from low to high is achieved.

Comparison of Maximum Holding Torque

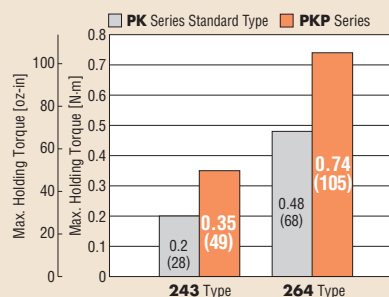

Compact and Flat Connector

The **PKP** Series uses a compact and flat connector, which shortens the length of the connector's overhang. In addition, the degree of freedom for the cable outlet direction has been increased, because the outlet direction points upward.

● Because the connector is provided for some products only, refer to dimensions of each model for details.

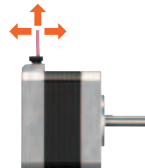

Lower Vibration

Revising the magnetic design has achieved lower vibration compared to conventional products.

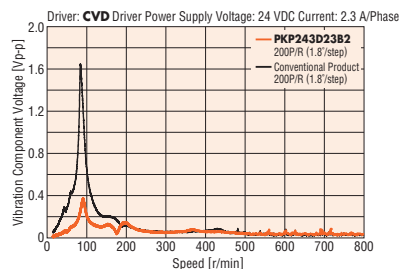

Downsizing

The **PKP** Series provides torque equivalent to a motor of the next larger frame size, allowing for the downsizing of equipment.

Torque Characteristics Comparison of **PKP244D15A2** and **PK264-01A**

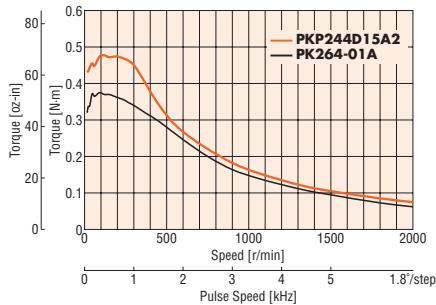

Provides torque equivalent to the next larger frame size!

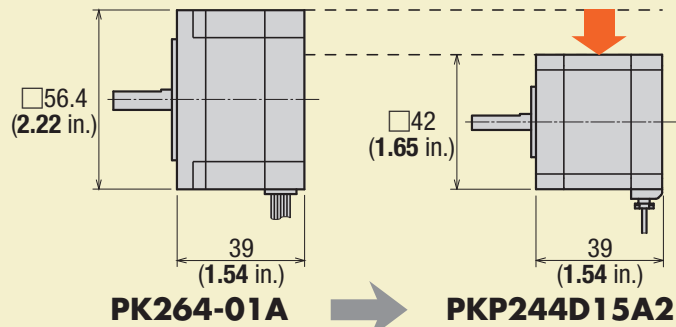

High-Resolution Type (0.9°/Step)

This is a high resolution stepper motor with a basic step angle of 0.9°. Stopping accuracy is improved.

● Increased Resolution (Compared to Standard Type)

The number of rotor teeth has doubled to 100 compared to 50 with the standard type. As a result, the basic step angle becomes 0.9°/step, which is half that of the standard type.

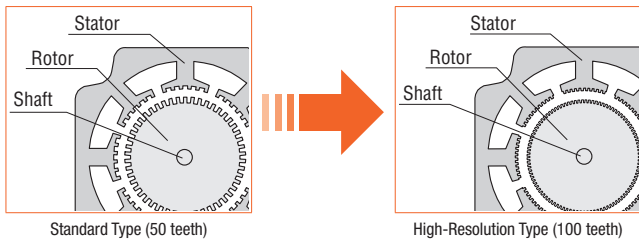

● Avoidance of Resonance Regions

If the pulse speed is within a resonance region, vibration may increase. Resonance regions can be avoided by switching to a 0.9° high-resolution type stepper motor.

● Improved Stopping Accuracy (Compared to Standard Type)

Stopping accuracy improves as the torque increases while minimizing the negative effect of the frictional load.

Comparison of Angle – Torque Characteristics

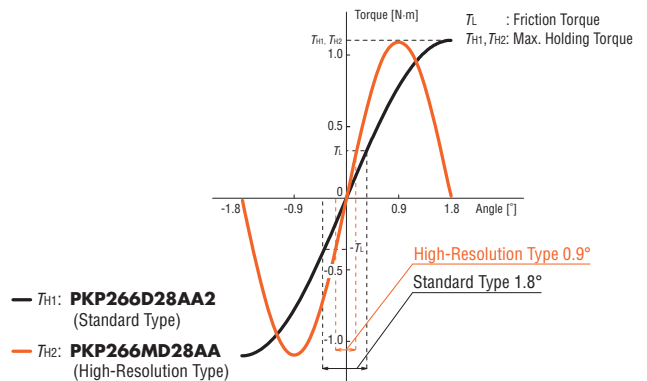

Flat Type

This is Oriental Motor's flattest type of 2-phase stepper motors.

● Flat and Lightweight Design

The motor can be installed in a narrow space by being flatter.

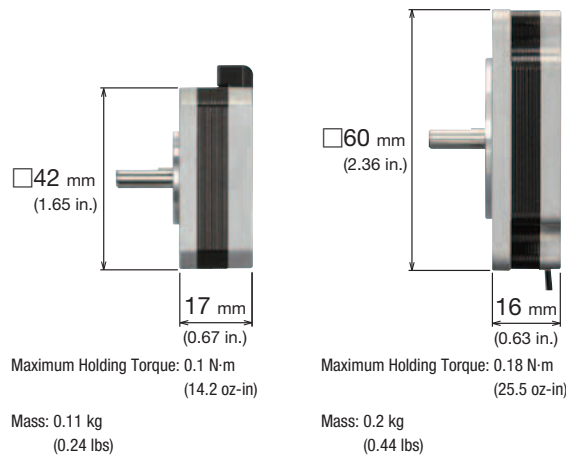

2-Phase
Motors
PKP

Features
Product
Line

Product
Number
Product Line

Standard
Type

High-
Resolution
Type

Flat Type

SH
Geared
Type

General
Specifications/
Inner Wiring
Diagram of Motor

5-Phase
Motors
PKP

Features
Product
Line

Product
Number
Product Line

Standard
Type

High-
Resolution
Type

TS
Geared
Type

General
Specifications/
Inner Wiring
Diagram of Motor

Driver for
2-Phase/
5-Phase Motors

Accessories

20 mm (0.79 in.)

28 mm (1.10 in.)

35 mm (1.38 in.)

42 mm (1.65 in.)

50 mm (1.97 in.)

56.4 mm (2.22 in.)

60 mm (2.36 in.)

85 mm (3.35 in.)

SH Geared Type

This type is advantageous for its deceleration, greater torque, higher resolution and anti-vibration measures. It experiences less backlash than conventional products. The increased speed range makes it even easier to use.

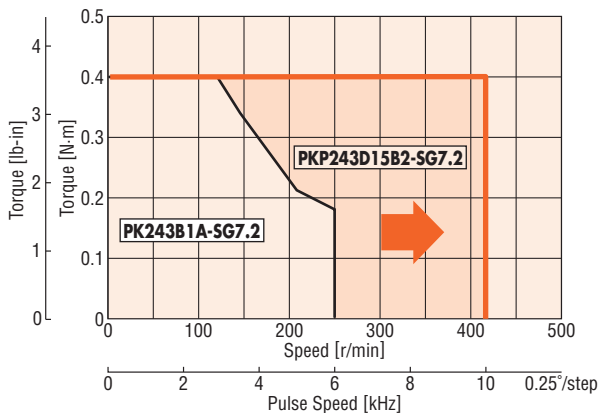

Product Line Equipped with Additional Functions to Further Broaden Applications

● With Encoder

(Provided for standard type and high-resolution type)

Encoder Specifications → Page 42

● Main Specifications

Type	Standard Type	High-Resolution Type
Resolution	200 P/R, 400 P/R	400 P/R
Output Signal	A Phase, B Phase, Z Phase (3ch)	



◇ Motor Position Detection is Possible

Monitoring the current position and detecting positional errors is possible. For example, comparing the command position and current position enables you to check the normal operation of the motor.

◇ Equipped with a Compact Encoder

● When frame size is 42 mm (1.65 in.)

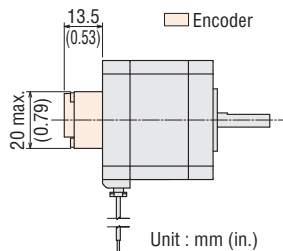

◇ High Reliability with Line Driver Output Circuit Type

Noise resistance is improved by differential output, and the wiring distance can be longer than with the voltage output type.

● With Electromagnetic Brake

(Provided for standard type and high-resolution type)

Electromagnetic Brake Specifications → Page 42

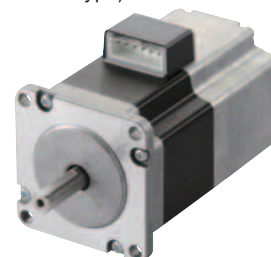

◇ Position Can Be Held When the Power Is OFF or a Power Failure Occurs

This type features an electromagnetic brake that activates when the power is off.

When the power is accidentally cut off due to a power failure or other unexpected event, the electromagnetic brake holds the load in position to prevent it from dropping or moving. Also, the load can be held by the electromagnetic brake when the motor is stopped, and the heat generated by the motor can be curtailed by switching the motor current off.

Drivers (Sold separately) → Page 62

Compact and lightweight bipolar drivers are available.

● Bipolar Drivers

● Right Angle Type with Installation Plate

The connector points outward.





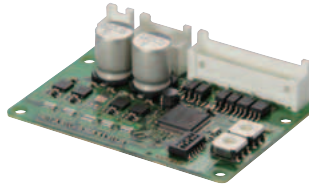

● Without Installation Plate

The connector points upward.



Product line

Motor Product Line (Basic Step Angle)	Frame Size, Wiring Type							
	20 mm (0.79 in.)	28 mm (1.10 in.)	35 mm (1.38 in.)	42 mm (1.65 in.)	50 mm (1.97 in.)	56.4 mm (2.22 in.)	60 mm (2.36 in.)	85 mm (3.35 in.)
	Bipolar	Bipolar	Bipolar	Bipolar	Bipolar	Bipolar	Bipolar	Bipolar
Standard Type (1.8°)								
 With Encoder	○	●	●	●	○*1	●	—	○
With Electromagnetic Brake	—	●	●	●	—	●	—	—
High-Resolution Type (0.9°)								
 With Encoder	—	—	—	●	—	●	—	—
With Electromagnetic Brake	—	—	—	●	—	●	—	—
Flat Type (1.8°)								
	—	—	—	●	—	—	○	—
SH Geared Type (0.5°~0.05°)								
	—	●	—	●	—	—	●	—

●: Connector Connection Method ○: Lead Wire Type

*1. This is the conventional **PK** series.

2-Phase
Motors
PKP

Features
Product
Line

Product
Number
Product Line

Standard
Type

High-
Resolution
Type

Flat Type

SH
Geared
Type

General
Specifications/
Inner Wiring
Diagram of Motor

5-Phase
Motors
PKP

Features
Product
Line

Product
Number
Product Line

Standard
Type

High-
Resolution
Type

TS
Geared
Type

General
Specifications/
Inner Wiring
Diagram of Motor

Driver for
2-Phase/
5-Phase Motors

Accessories

System Configuration

These accessories allow 2-phase stepper motors in the **PKP** Series to be used for various operations. Motors and cables must be ordered individually.

Motor Frame Size

20 mm (0.79 in.)

28 mm (1.10 in.)

35 mm (1.38 in.)

42 mm (1.65 in.)

50 mm (1.97 in.)

56.4 mm (2.22 in.)

60 mm (2.36 in.)

85 mm (3.35 in.)

2-Phase PKP Series

Motor

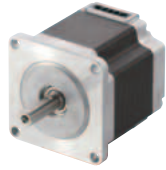

A connector-coupled motor requires a connection cable.

Connection cable

Sold separately

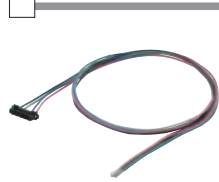

→ Page 70

Required Drive Products (Sold separately)



Bipolar Driver
→ Page 62

Programmable Controller*

Accessories (Sold separately)



MCS Couplings
→ Page 72



Motor Mounting Brackets
→ Page 72



Clean Dampers
→ Page 73

Controller

Pulse generators are available.



→ Page 74

*Not supplied.

Example of System Configuration

2-Phase PKP Series	
Motor	Connection cable
PKP264D28BA2	LC2B06E
\$58.00	\$6.00

+

Accessories		
Motor Mounting Brackets	Flexible Couplings	Clean Dampers
PAL2P-2	MCV190808	D6CL-6.3F
\$17.00	\$72.00	\$42.00

The system configuration shown above is an example. Other combinations are also available.

Product Number

Motor

PKP Series

◇ Standard Type/Standard Type with an Electromagnetic Brake

PKP 2 6 4 D 28 A A 2

① ② ③ ④ ⑤ ⑥ ⑦ ⑧ ⑨ ⑩

◇ High-Resolution Type/High-Resolution Type with an Electromagnetic Brake

PKP 2 6 4 M D 28 A A

① ② ③ ④ ⑤ ⑥ ⑦ ⑧ ⑨

①	Series Name	PKP: PKP Series
②	2: 2-Phase	
③	Motor Frame Size	1: 20 mm (0.79 in.) 2: 28 mm (1.10 in.) 3: 35 mm (1.38 in.) 4: 42 mm (1.65 in.) 6: 56.4 mm (2.22 in.)* 9: 85 mm (3.35 in.)
④	Motor Case Length	
⑤	Motor Type	Blank: Standard Type M: High-resolution Type
⑥	Number of Lead Wires	D: 4 Leads U: 5 or 6 Leads
⑦	Motor Winding Specifications	
⑧	Configuration	A: Single Shaft B: Double Shaft M: Type with an Electromagnetic Brake
⑨	Output Shaft Diameter	A: Imperial Blank: Metric
⑩	Reference Number	

*φ6.35 [φ0.25 (1/4")] shaft featured on Standard Type only. See drawings for details. Please contact your nearest Oriental Motor sales office for additional support.

◇ Standard Type with Encoder

PKP 2 4 3 D 15 A 2 - R2F L

① ② ③ ④ ⑤ ⑥ ⑦ ⑧ ⑨ ⑩ ⑪

◇ High-Resolution Type with Encoder

PKP 2 4 3 M D 15 A - R2F L

① ② ③ ④ ⑤ ⑥ ⑦ ⑧ ⑩ ⑪

①	Series Name	PKP: PKP Series
②	2: 2-Phase	
③	Motor Frame Size	1: 20 mm (0.79 in.) 2: 28 mm (1.10 in.) 3: 35 mm (1.38 in.) 4: 42 mm (1.65 in.) 6: 56.4 mm (2.22 in.)
④	Motor Case Length	
⑤	Motor Type	Blank: Standard Type M: High-resolution Type
⑥	Number of Lead Wires	D: 4 Leads U: 5 or 6 Leads
⑦	Motor Winding Specifications	
⑧	Configuration	A: Single Shaft
⑨	Reference Number	
⑩	Encoder Resolution	R2E: 200 P/R R2F: 400 P/R
⑪	Encoder Output Circuit Type	L: Line Driver Output*

*A voltage output type of encoder output circuit is also available. For details, please contact your nearest Oriental Motor sales office.

◇ Flat Type

PKP 2 4 2 D 23 A 2

① ② ③ ④ ⑤ ⑥ ⑦ ⑧ ⑩

PKP 2 6 2 F D 15 A W

① ② ③ ④ ⑤ ⑥ ⑦ ⑧ ⑨

①	Series Name	PKP: PKP Series
②	2: 2-Phase	
③	Motor Frame Size	4: 42 mm (1.65 in.) 6: 60 mm (2.36 in.)
④	Motor Case Length	
⑤	Motor Classification	F: Motor Frame Size of 60 mm (2.36 in.)
⑥	Number of Lead Wires	D: 4 Leads
⑦	Motor Winding Specifications	
⑧	Configuration	A: Single Shaft
⑨	Cable Identification	Blank: Connector-Coupled Motors W: Lead Wire Type
⑩	Reference Number	

● Connection cable

◇ Connection Cable for Motor

LC 2 B 06 A

① ② ③ ④ ⑤

①	Cables	LC: Connector Leads
②	2: 2-Phase	
③	Cable Type	B: For Bipolar U: For Unipolar
④	Cable Length	06: 0.6 m (2 ft.) 10: 1 m (3.3 ft.)
⑤	Reference Number	

◇ SH Geared Type

PKP 2 4 3 D 15 B 2 - SG 18

① ② ③ ④ ⑤ ⑥ ⑦ ⑧ ⑨ ⑩

①	Series Name	PKP: PKP Series
②	2: 2-Phase	
③	Motor Frame Size	2: 28 mm (1.10 in.) 4: 42 mm (1.65 in.) 6: 60 mm (2.36 in.)
④	Motor Case Length	
⑤	Number of Lead Wires	D: 4 Leads U: 5 or 6 Leads
⑥	Motor Winding Specifications	
⑦	Configuration	A: Single Shaft B: Double Shaft
⑧	Reference Number	
⑨	Gear Type	SG: SH Geared Type
⑩	Gear Ratio	

PK Series

◇ Standard Type (Unipolar 6 lead wires)

PK 2 5 6 - 0 2 B

① ② ③ ④ ⑤ ⑥ ⑦

①	Series Name	PK: PK Series
②	2: 2-Phase	
③	Motor Frame Size	5: 50 mm (1.97 in.)
④	Motor Case Length	
⑤	Reference Number	
⑥	Motor Winding Specifications	
⑦	Configuration	A: Single Shaft B: Double Shaft

◇ Connection Cable for Encoder

LC E 08 A - 006

① ② ③ ④ ⑤

①	Cables	LC: Connector Leads
②	Cable Type	E: For Encoder
③	Applicable Models	05: Voltage Output 08: Line Driver Output
④	Reference Number	
⑤	Cable Length	006: 0.6 m (2 ft.)

2-Phase
Motors
PKP

Features
Product
Line

Product
Number
Product Line

Standard
Type

High-
Resolution
Type

Flat Type

SH
Geared
Type

General
Specifications/
Inner Wiring
Diagram of Motor

5-Phase
Motors
PKP

Features
Product
Line

Product
Number
Product Line

Standard
Type

High-
Resolution
Type

TS
Geared
Type

General
Specifications/
Inner Wiring
Diagram of Motor

Driver for
2-Phase/
5-Phase Motors

Accessories

Product Line

A connector-coupled motor requires a connection cable.
Motors and connection cables must be ordered separately.

● Motor

◇ Standard Type, Standard Type with Encoder, Standard Type with Electromagnetic Brake

● Bipolar

Product Name (Single Shaft)	List Price	Product Name (Double Shaft)	List Price
PKP213D05A	\$65.00	PKP213D05B	\$67.00
PKP214D06A	\$72.00	PKP214D06B	\$74.00
PKP223D15A2	\$50.00	PKP223D15B2	\$52.00
PKP225D15A2	\$57.00	PKP225D15B2	\$59.00
PKP233D15A	\$48.00	PKP233D15B	\$50.00
PKP233D23A	\$48.00	PKP233D23B	\$50.00
PKP235D15A	\$55.00	PKP235D15B	\$57.00
PKP235D23A	\$55.00	PKP235D23B	\$57.00
PKP243D08A2	\$45.00	PKP243D08B2	\$47.00
PKP243D15A2	\$45.00	PKP243D15B2	\$47.00
PKP243D23A2	\$45.00	PKP243D23B2	\$47.00
PKP244D08A2	\$47.00	PKP244D08B2	\$49.00
PKP244D15A2	\$47.00	PKP244D15B2	\$49.00
PKP244D23A2	\$47.00	PKP244D23B2	\$49.00
PKP245D08A2	\$53.00	PKP245D08B2	\$55.00
PKP245D15A2	\$53.00	PKP245D15B2	\$55.00
PKP245D23A2	\$53.00	PKP245D23B2	\$55.00
PKP246D15A2	\$56.00	PKP246D15B2	\$58.00
PKP246D23A2	\$56.00	PKP246D23B2	\$58.00
PKP264D14AA2	\$56.00	PKP264D14BA2	\$58.00
PKP264D28AA2	\$56.00	PKP264D28BA2	\$58.00
PKP264D42AA2	\$56.00	PKP264D42BA2	\$58.00
PKP266D14AA2	\$62.00	PKP266D14BA2	\$64.00
PKP266D28AA2	\$62.00	PKP266D28BA2	\$64.00
PKP266D42AA2	\$62.00	PKP266D42BA2	\$64.00
PKP268D14A2*	\$76.00	PKP268D14B2*	\$79.00
PKP268D28A2*	\$76.00	PKP268D28B2*	\$79.00
PKP268D42A2*	\$76.00	PKP268D42B2*	\$79.00
PKP296D45AA	\$108.00	PKP296D45BA	\$112.00
PKP296D63AA	\$108.00	PKP296D63BA	\$112.00
PKP299D45AA	\$165.00	PKP299D45BA	\$171.00
PKP299D63AA	\$165.00	PKP299D63BA	\$171.00
PKP2913D45AA	\$209.00	PKP2913D45BA	\$218.00
PKP2913D56AA	\$209.00	PKP2913D56BA	\$218.00

*Output shaft is 8 mm. See drawing for details.

● Bipolar with Electromagnetic Brake

Product Name	List Price
PKP223D15M2	\$115.00
PKP225D15M2	\$122.00
PKP233D15M	\$148.00
PKP235D15M	\$155.00
PKP243D15M	\$148.00
PKP244D15M	\$149.00
PKP245D15M	\$155.00
PKP246D15M	\$157.00
PKP264D28M	\$171.00
PKP266D28M	\$177.00
PKP268D28M	\$193.00

● Bipolar with Encoder

Product Name (Voltage)	List Price	Product Name (Line Driver)	List Price
PKP213D05A-R2E	\$148.00	PKP213D05A-R2EL	\$148.00
PKP214D06A-R2E	\$155.00	PKP214D06A-R2EL	\$155.00
PKP223D15A2-R2E	\$123.00	PKP223D15A2-R2EL	\$123.00
PKP225D15A2-R2E	\$133.00	PKP225D15A2-R2EL	\$133.00
PKP233D15A-R2E	\$123.00	PKP233D15A-R2EL	\$123.00
PKP235D15A-R2E	\$130.00	PKP235D15A-R2EL	\$130.00
PKP243D15A2-R2E	\$104.00	PKP243D15A2-R2EL	\$104.00
PKP243D15A2-R2F	\$104.00	PKP243D15A2-R2FL	\$104.00
PKP243D23A2-R2E	\$104.00	PKP243D23A2-R2EL	\$104.00
PKP243D23A2-R2F	\$104.00	PKP243D23A2-R2FL	\$104.00
PKP244D15A2-R2E	\$106.00	PKP244D15A2-R2EL	\$106.00
PKP244D15A2-R2F	\$106.00	PKP244D15A2-R2FL	\$106.00
PKP244D23A2-R2E	\$106.00	PKP244D23A2-R2EL	\$106.00
PKP244D23A2-R2F	\$106.00	PKP244D23A2-R2FL	\$106.00
PKP245D15A2-R2E	\$113.00	PKP245D15A2-R2EL	\$113.00
PKP245D15A2-R2F	\$113.00	PKP245D15A2-R2FL	\$113.00
PKP245D23A2-R2E	\$113.00	PKP245D23A2-R2EL	\$113.00
PKP245D23A2-R2F	\$113.00	PKP245D23A2-R2FL	\$113.00
PKP246D15A2-R2E	\$115.00	PKP246D15A2-R2EL	\$115.00
PKP246D15A2-R2F	\$115.00	PKP246D15A2-R2FL	\$115.00
PKP246D23A2-R2E	\$115.00	PKP246D23A2-R2EL	\$115.00
PKP246D23A2-R2F	\$115.00	PKP246D23A2-R2FL	\$115.00
PKP264D14A2-R2E	\$115.00	PKP264D14A2-R2EL	\$115.00
PKP264D14A2-R2F	\$115.00	PKP264D14A2-R2FL	\$115.00
PKP264D28A2-R2E	\$115.00	PKP264D28A2-R2EL	\$115.00
PKP264D28A2-R2F	\$115.00	PKP264D28A2-R2FL	\$115.00
PKP264D42A2-R2E	\$115.00	PKP264D42A2-R2EL	\$115.00
PKP264D42A2-R2F	\$115.00	PKP264D42A2-R2FL	\$115.00
PKP266D14A2-R2E	\$121.00	PKP266D14A2-R2EL	\$121.00
PKP266D14A2-R2F	\$121.00	PKP266D14A2-R2FL	\$121.00
PKP266D28A2-R2E	\$121.00	PKP266D28A2-R2EL	\$121.00
PKP266D28A2-R2F	\$121.00	PKP266D28A2-R2FL	\$121.00
PKP266D42A2-R2E	\$121.00	PKP266D42A2-R2EL	\$121.00
PKP266D42A2-R2F	\$121.00	PKP266D42A2-R2FL	\$121.00
PKP268D14A2-R2E	\$138.00	PKP268D14A2-R2EL	\$138.00
PKP268D14A2-R2F	\$138.00	PKP268D14A2-R2FL	\$138.00
PKP268D28A2-R2E	\$138.00	PKP268D28A2-R2EL	\$138.00
PKP268D28A2-R2F	\$138.00	PKP268D28A2-R2FL	\$138.00
PKP268D42A2-R2E	\$138.00	PKP268D42A2-R2EL	\$138.00
PKP268D42A2-R2F	\$138.00	PKP268D42A2-R2FL	\$138.00

◇ Flat Type

● Bipolar

Product Name	List Price
PKP242D23A2	\$52.00
PKP262FD15AW	\$58.00

Motor
Frame Size

□ 20 mm
(0.79 in.)

□ 28 mm
(1.10 in.)

□ 35 mm
(1.38 in.)

□ 42 mm
(1.65 in.)

□ 50 mm
(1.97 in.)

□ 56.4 mm
(2.22 in.)

□ 60 mm
(2.36 in.)

□ 85 mm
(3.35 in.)

◇ High-Resolution Type, High-Resolution Type with Encoder, High-Resolution Type with Electromagnetic Brake

● Bipolar

Product Name (Single Shaft)	List Price	Product Name (Double Shaft)	List Price
PKP243MD15A	\$48.00	PKP243MD15B	\$50.00
PKP244MD15A	\$49.00	PKP244MD15B	\$51.00
PKP264MD28AA	\$56.00	PKP264MD28BA	\$58.00
PKP266MD28AA	\$62.00	PKP266MD28BA	\$64.00
PKP268MD28AA	\$78.00	PKP268MD28BA	\$80.00

● Bipolar with Electromagnetic Brake

Product Name	List Price
PKP243MD15M	\$148.00
PKP244MD15M	\$149.00
PKP264MD28M	\$171.00
PKP266MD28M	\$177.00
PKP268MD28M	\$193.00

◇ SH Geared Type

● Bipolar

Product Name (Single Shaft)	List Price	Product Name (Double Shaft)	List Price
PKP223D15A-SG7.2	\$168.00	PKP223D15B-SG7.2	\$170.00
PKP223D15A-SG9	\$168.00	PKP223D15B-SG9	\$170.00
PKP223D15A-SG10	\$168.00	PKP223D15B-SG10	\$170.00
PKP223D15A-SG18	\$182.00	PKP223D15B-SG18	\$184.00
PKP223D15A-SG36	\$182.00	PKP223D15B-SG36	\$184.00
PKP243D15A2-SG3.6	\$121.00	PKP243D15B2-SG3.6	\$123.00
PKP243D23A2-SG3.6	\$121.00	PKP243D23B2-SG3.6	\$123.00
PKP243D15A2-SG7.2	\$121.00	PKP243D15B2-SG7.2	\$123.00
PKP243D23A2-SG7.2	\$121.00	PKP243D23B2-SG7.2	\$123.00
PKP243D15A2-SG9	\$121.00	PKP243D15B2-SG9	\$123.00
PKP243D23A2-SG9	\$121.00	PKP243D23B2-SG9	\$123.00
PKP243D15A2-SG10	\$121.00	PKP243D15B2-SG10	\$123.00
PKP243D23A2-SG10	\$121.00	PKP243D23B2-SG10	\$123.00
PKP243D15A2-SG18	\$138.00	PKP243D15B2-SG18	\$140.00
PKP243D23A2-SG18	\$138.00	PKP243D23B2-SG18	\$140.00
PKP243D15A2-SG36	\$138.00	PKP243D15B2-SG36	\$140.00
PKP243D23A2-SG36	\$138.00	PKP243D23B2-SG36	\$140.00
PKP264D14A2-SG3.6	\$138.00	PKP264D14B2-SG3.6	\$141.00
PKP264D28A2-SG3.6	\$138.00	PKP264D28B2-SG3.6	\$141.00
PKP264D14A2-SG7.2	\$138.00	PKP264D14B2-SG7.2	\$141.00
PKP264D28A2-SG7.2	\$138.00	PKP264D28B2-SG7.2	\$141.00
PKP264D14A2-SG9	\$138.00	PKP264D14B2-SG9	\$141.00
PKP264D28A2-SG9	\$138.00	PKP264D28B2-SG9	\$141.00
PKP264D14A2-SG10	\$138.00	PKP264D14B2-SG10	\$141.00
PKP264D28A2-SG10	\$138.00	PKP264D28B2-SG10	\$141.00
PKP264D14A2-SG18	\$154.00	PKP264D14B2-SG18	\$157.00
PKP264D28A2-SG18	\$154.00	PKP264D28B2-SG18	\$157.00
PKP264D14A2-SG36	\$154.00	PKP264D14B2-SG36	\$157.00
PKP264D28A2-SG36	\$154.00	PKP264D28B2-SG36	\$157.00

● Bipolar with Encoder

Product Name (Voltage)	List Price	Product Name (Line Driver)	List Price
PKP243MD15A-R2F	\$133.00	PKP243MD15A-R2FL	\$133.00
PKP244MD15A-R2F	\$134.00	PKP244MD15A-R2FL	\$134.00
PKP264MD28A-R2F	\$131.00	PKP264MD28A-R2FL	\$131.00
PKP266MD28A-R2F	\$137.00	PKP266MD28A-R2FL	\$137.00
PKP268MD28A-R2F	\$153.00	PKP268MD28A-R2FL	\$153.00

● Connection Cable

◇ Motor Cable (For bipolar)

Product Name	Length m (ft.)	List Price
LC2B06A	0.6 (2)	\$5.00
LC2B06B	0.6 (2)	\$5.00
LC2B06C	0.6 (2)	\$5.00
LC2B06E	0.6 (2)	\$6.00

◇ Encoder Type

Product Name	Length m (ft.)	List Price
LCE05A-006	0.6 (2)	\$11.00
LCE08A-006	0.6 (2)	\$11.00

■ Included

Type	Included	Surge Suppressor	Operating Manual
Standard			
High-Resolution		—	1 Copy
SH Geared			
with Electromagnetic Brake		1 pc.	

2-Phase
Motors
PKP

Features
Product
Line

Product
Number
Product Line

Standard
Type

High-
Resolution
Type

Flat Type

SH
Geared
Type

General
Specifications/
Inner Wiring
Diagram of Motor

5-Phase
Motors
PKP

Features
Product
Line

Product
Number
Product Line

Standard
Type

High-
Resolution
Type

TS
Geared
Type

General
Specifications/
Inner Wiring
Diagram of Motor

Driver for
2-Phase/
5-Phase Motors

Accessories

Motor Frame Size

20 mm (0.79 in.)

28 mm (1.10 in.)

35 mm (1.38 in.)

42 mm (1.65 in.)

50 mm (1.97 in.)

56.4 mm (2.22 in.)

60 mm (2.36 in.)

85 mm (3.35 in.)

◇ Standard Type, Standard Type with Encoder, Standard Type with Electromagnetic Brake

● Unipolar

Product Name (Single Shaft)	List Price	Product Name (Double Shaft)	List Price
PKP213U05A	\$65.00	PKP213U05B	\$67.00
PKP214U06A	\$72.00	PKP214U06B	\$74.00
PKP223U09A2	\$50.00	PKP223U09B2	\$52.00
PKP225U09A2	\$57.00	PKP225U09B2	\$59.00
PKP233U12A	\$48.00	PKP233U12B	\$50.00
PKP235U12A	\$55.00	PKP235U12B	\$57.00
PKP243U08A2	\$45.00	PKP243U08B2	\$47.00
PKP243U09A2	\$45.00	PKP243U09B2	\$47.00
PKP243U12A2	\$45.00	PKP243U12B2	\$47.00
PKP244U08A2	\$47.00	PKP244U08B2	\$49.00
PKP244U12A2	\$47.00	PKP244U12B2	\$49.00
PKP245U08A2	\$53.00	PKP245U08B2	\$55.00
PKP245U12A2	\$53.00	PKP245U12B2	\$55.00
PKP246U12A2	\$56.00	PKP246U12B2	\$58.00
PKP246U16A2	\$56.00	PKP246U16B2	\$58.00
PK256-02A	\$78.00	PK256-02B	\$81.00
PK258-02A	\$78.00	PK258-02B	\$89.00
PKP264U10AA2	\$56.00	PKP264U10BA2	\$58.00
PKP264U20AA2	\$56.00	PKP264U20BA2	\$58.00
PKP266U10AA2	\$62.00	PKP266U10BA2	\$64.00
PKP266U20AA2	\$62.00	PKP266U20BA2	\$64.00
PKP268U10A2*	\$76.00	PKP268U10B2*	\$79.00
PKP268U20A2*	\$76.00	PKP268U20B2*	\$79.00
PKP296U20AA	\$108.00	PKP296U20BA	\$112.00
PKP296U30AA	\$108.00	PKP296U30BA	\$112.00
PKP296U45AA	\$108.00	PKP296U45BA	\$112.00
PKP299U20AA	\$165.00	PKP299U20BA	\$171.00
PKP299U30AA	\$165.00	PKP299U30BA	\$171.00
PKP299U45AA	\$165.00	PKP299U45BA	\$171.00
PKP2913U20AA	\$209.00	PKP2913U20BA	\$218.00
PKP2913U40AA	\$209.00	PKP2913U40BA	\$218.00

*Output shaft is 8 mm. See drawing for details.

● Unipolar with Electromagnetic Brake

Product Name	List Price
PKP223U09M2	\$115.00
PKP225U09M2	\$122.00
PKP233U12M	\$148.00
PKP235U12M	\$155.00
PKP243U09M	\$148.00
PKP244U12M	\$149.00
PKP245U12M	\$155.00
PKP246U12M	\$157.00
PKP264U20M	\$171.00
PKP266U20M	\$177.00
PKP268U20M	\$193.00

◇ High-Resolution Type, High-Resolution Type with Encoder, High-Resolution Type with Electromagnetic Brake

● Unipolar

Product Name (Single Shaft)	List Price	Product Name (Double Shaft)	List Price
PKP243MU09A	\$48.00	PKP243MU09B	\$50.00
PKP244MU12A	\$49.00	PKP244MU12B	\$51.00
PKP264MU20AA	\$56.00	PKP264MU20BA	\$58.00
PKP266MU20AA	\$62.00	PKP266MU20BA	\$64.00
PKP268MU20AA	\$78.00	PKP268MU20BA	\$80.00

● Unipolar with Electromagnetic Brake

Product Name	List Price
PKP243MU09M	\$148.00
PKP244MU12M	\$149.00
PKP264MU20M	\$171.00
PKP266MU20M	\$177.00
PKP268MU20M	\$193.00

● Unipolar with Encoder

Product Name (Voltage)	List Price	Product Name (Line Driver)	List Price
PKP213U05A-R2E	\$148.00	PKP213U05A-R2EL	\$148.00
PKP214U06A-R2E	\$155.00	PKP214U06A-R2EL	\$155.00
PKP223U09A2-R2E	\$123.00	PKP223U09A2-R2EL	\$123.00
PKP225U09A2-R2E	\$133.00	PKP225U09A2-R2EL	\$133.00
PKP233U12A-R2E	\$123.00	PKP233U12A-R2EL	\$123.00
PKP235U12A-R2E	\$130.00	PKP235U12A-R2EL	\$130.00
PKP243U09A2-R2E	\$104.00	PKP243U09A2-R2EL	\$104.00
PKP243U09A2-R2F	\$104.00	PKP243U09A2-R2FL	\$104.00
PKP244U12A2-R2E	\$106.00	PKP244U12A2-R2EL	\$106.00
PKP244U12A2-R2F	\$106.00	PKP244U12A2-R2FL	\$106.00
PKP245U12A2-R2E	\$113.00	PKP245U12A2-R2EL	\$113.00
PKP245U12A2-R2F	\$113.00	PKP245U12A2-R2FL	\$113.00
PKP246U12A2-R2E	\$115.00	PKP246U12A2-R2EL	\$115.00
PKP246U12A2-R2F	\$115.00	PKP246U12A2-R2FL	\$115.00
PKP264U10A2-R2E	\$115.00	PKP264U10A2-R2EL	\$115.00
PKP264U10A2-R2F	\$115.00	PKP264U10A2-R2FL	\$115.00
PKP264U20A2-R2E	\$115.00	PKP264U20A2-R2EL	\$115.00
PKP264U20A2-R2F	\$115.00	PKP264U20A2-R2FL	\$115.00
PKP266U10A2-R2E	\$121.00	PKP266U10A2-R2EL	\$121.00
PKP266U10A2-R2F	\$121.00	PKP266U10A2-R2FL	\$121.00
PKP266U20A2-R2E	\$121.00	PKP266U20A2-R2EL	\$121.00
PKP266U20A2-R2F	\$121.00	PKP266U20A2-R2FL	\$121.00
PKP268U10A2-R2E	\$138.00	PKP268U10A2-R2EL	\$138.00
PKP268U10A2-R2F	\$138.00	PKP268U10A2-R2FL	\$138.00
PKP268U20A2-R2E	\$138.00	PKP268U20A2-R2EL	\$138.00
PKP268U20A2-R2F	\$138.00	PKP268U20A2-R2FL	\$138.00

◇ **SH** Geared Type

● Unipolar

Product Name (Single Shaft)	List Price	Product Name (Double Shaft)	List Price
PKP223U09A-SG7.2	\$168.00	PKP223U09B-SG7.2	\$170.00
PKP223U09A-SG9	\$168.00	PKP223U09B-SG9	\$170.00
PKP223U09A-SG10	\$168.00	PKP223U09B-SG10	\$170.00
PKP223U09A-SG18	\$182.00	PKP223U09B-SG18	\$184.00
PKP223U09A-SG36	\$182.00	PKP223U09B-SG36	\$184.00
PKP243U09A2-SG3.6	\$121.00	PKP243U09B2-SG3.6	\$123.00
PKP243U09A2-SG7.2	\$121.00	PKP243U09B2-SG7.2	\$123.00
PKP243U09A2-SG9	\$121.00	PKP243U09B2-SG9	\$123.00
PKP243U09A2-SG10	\$121.00	PKP243U09B2-SG10	\$123.00
PKP243U09A2-SG18	\$138.00	PKP243U09B2-SG18	\$140.00
PKP243U09A2-SG36	\$138.00	PKP243U09B2-SG36	\$140.00
PKP264U10A2-SG3.6	\$138.00	PKP264U10B2-SG3.6	\$141.00
PKP264U20A2-SG3.6	\$138.00	PKP264U20B2-SG3.6	\$141.00
PKP264U10A2-SG7.2	\$138.00	PKP264U10B2-SG7.2	\$141.00
PKP264U20A2-SG7.2	\$138.00	PKP264U20B2-SG7.2	\$141.00
PKP264U10A2-SG9	\$138.00	PKP264U10B2-SG9	\$141.00
PKP264U20A2-SG9	\$138.00	PKP264U20B2-SG9	\$141.00
PKP264U10A2-SG10	\$138.00	PKP264U10B2-SG10	\$141.00
PKP264U20A2-SG10	\$138.00	PKP264U20B2-SG10	\$141.00
PKP264U10A2-SG18	\$154.00	PKP264U10B2-SG18	\$157.00
PKP264U20A2-SG18	\$154.00	PKP264U20B2-SG18	\$157.00
PKP264U10A2-SG36	\$154.00	PKP264U10B2-SG36	\$157.00
PKP264U20A2-SG36	\$154.00	PKP264U20B2-SG36	\$157.00

● Connection Cable

◇ Motor Cable (For unipolar)

Product Name	Length m (ft.)	List Price
LC2U06A	0.6 (2)	\$5.00
LC2U10A	1 (3.3)	\$7.00
LC2U06B	0.6 (2)	\$5.00
LC2U10B	1 (3.3)	\$7.00
LC2U06C	0.6 (2)	\$5.00
LC2U10C	1 (3.3)	\$8.00
LC2U06E	0.6 (2)	\$6.00

◇ Encoder Type

Product Name	Length m (ft.)	List Price
LCE05A-006	0.6 (2)	\$11.00
LCE08A-006	0.6 (2)	\$11.00

■ Included

Type	Included	Surge Suppressor	Operating Manual
Standard High-Resolution SH Geared		—	1 Copy
with Electromagnetic Brake		1 pc.	

■ Description of Terms in Specification Table

Maximum Holding Torque	: This is the max. holding torque (holding force) the stepper motor has when power is supplied (at rated current) but the motor is not rotating. (With geared types, the value of holding torque considers the permissible strength of the gear.)
Permissible Torque	: This is the max. value of torque which can be applied continuously to the output gear shaft. For the SH geared type, make sure that the applied torque, including during acceleration and deceleration, does not exceed the permissible torque.
Maximum Instantaneous Torque	: This is the max. torque that can be applied to the output gear shaft during acceleration/deceleration such when an inertial load is started and stopped.
Holding Torque at Motor Standstill	: Holding torque when the automatic current cutback function is active.

Standard Type

Standard Type with Encoder

Frame Size 20 mm (0.79 in.) (Bipolar 4 Lead Wires)

Specifications

Product Name	Maximum Holding Torque N·m (oz·in)	Rotor Inertia J: kg·m ² (oz·in ²)	Rated Current A/Phase	Voltage VDC	Winding Resistance Ω/Phase	Inductance mH/Phase	Basic Step Angle	Recommended Driver Product Name*
PKP213D05□	0.02 (2.8)	1.6×10^{-7} (0.0088)	0.5	4.25	8.5	4.1	1.8°	CVD205BR-K
PKP214D06□	0.036 (5.1)	2.9×10^{-7} (0.0159)	0.6	3.9	6.5	3.5		CVD206BR-K
PKP213D05A-R2E■	0.02 (2.8)	1.66×10^{-7} (0.0091)	0.5	4.25	8.5	4.1		CVD205BR-K
PKP214D06A-R2E■	0.036 (5.1)	2.96×10^{-7} (0.0162)	0.6	3.9	6.5	3.5		CVD206BR-K

● The box □ in the product name indicates the shaft **A** (single shaft) or **B** (double shaft).

The box ■ in the product name indicates the encoder output circuit type **L** (line driver output). The voltage output type will have no "■" in the product name.

● See page 42 for encoder specifications.

* See page 64 for details on the recommended drivers.

Speed – Torque Characteristics (Reference Values) fs: Max. Starting Frequency

PKP213D

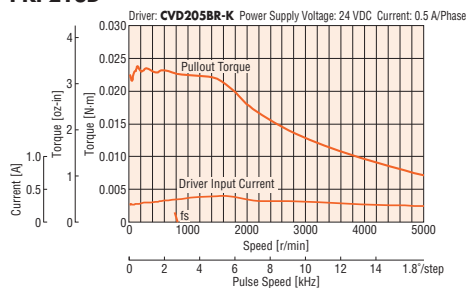

PKP214D

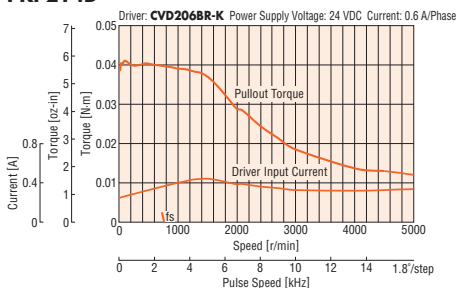

Note

- Data for the speed – torque characteristics is based on Oriental Motor's internal measurement conditions. If the conditions are changed, the characteristics may also change as a result.
- Depending on the driving conditions, a considerable amount of heat may be generated by the motor. Be sure to keep the temperature of the motor case under 100°C (212°F).
- For motors with encoders, to protect the encoder, keep the motor case temperature at 85°C (185°F) max.
- Set the current of the driver so that it does not exceed the rated current of the motor.

Dimensions Unit = mm (in.)

● Motor

2D & 3D CAD

Product Name	L1	L2	Mass kg (lb.)	2D CAD
PKP213D05A	30	—	0.05	B976
PKP213D05B	(1.18)	38 (1.50)	(0.110)	
PKP214D06A	40	—	0.07	B978
PKP214D06B	(1.57)	48 (1.89)	(0.154)	

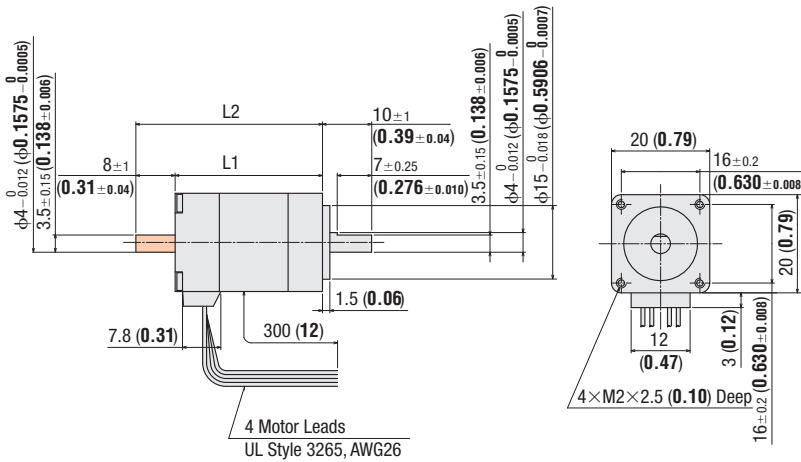

- These dimensions are for double shaft products. For single shaft products, ignore the  areas.
- Back shaft of double shaft products have a flat the whole length.

● Motor with Encoder

2D CAD

Product Name	Motor Product Name	L	Mass kg (lb.)	2D CAD
PKP213D05A-R2E	PKP213D05A-R2E	46.5 (1.83)	0.06 (0.132)	B1100
PKP214D06A-R2E	PKP214D06A-R2E	56.5 (2.22)	0.08 (0.176)	B1101

- Applicable Connector (Molex)

	Encoder
Connector Housing	51021-0800
Contact	50079-8100
Crimp Tool	57067-3000

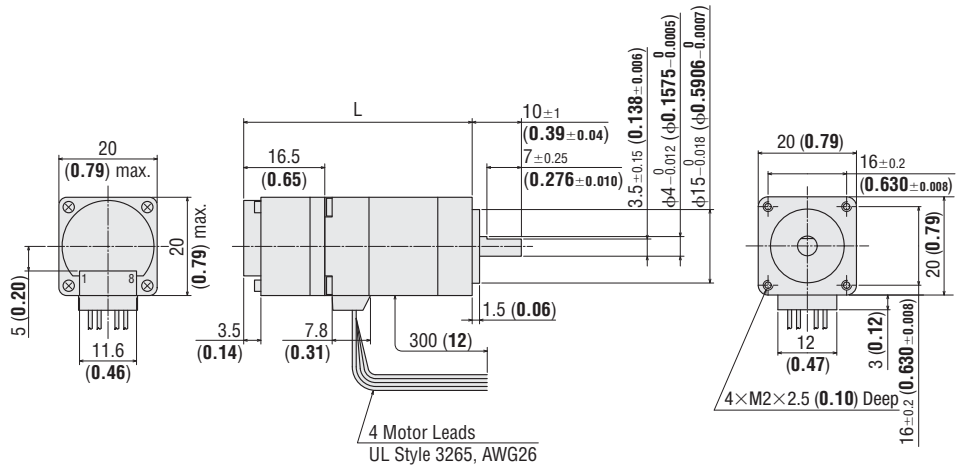

● Encoder Connection Cable (Sold Separately)

Product Name	Applicable Encoder	Length L m (ft.)
LCE05A-006	Voltage Output	0.6 (2)
LCE08A-006	Line Driver Output	0.6 (2)

◇ Voltage Output

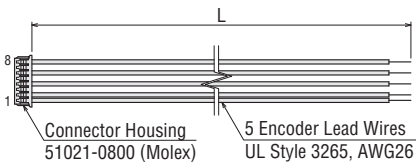

◇ Line Driver Output

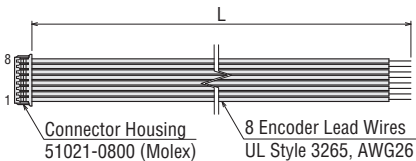

Inner Wiring Diagram of Motor

Wiring Diagram No.: Model C5

- Refer to page 44 for inner wiring diagram of motor.

2-Phase
Motors
PKP

Features
Product
Line

Product
Number
Product Line

Standard
Type

High-
Resolution
Type

Flat Type

SH
Geared
Type

General
Specifications/
Inner Wiring
Diagram of Motor

5-Phase
Motors
PKP

Features
Product
Line

Product
Number
Product Line

Standard
Type

High-
Resolution
Type

TS
Geared
Type

General
Specifications/
Inner Wiring
Diagram of Motor

Driver for
2-Phase/
5-Phase Motors

Accessories

Motor Frame Size

20 mm (0.79 in.)

28 mm (1.10 in.)

35 mm (1.38 in.)

42 mm (1.65 in.)

50 mm (1.97 in.)

56.4 mm (2.22 in.)

60 mm (2.36 in.)

85 mm (3.35 in.)

Standard Type

Standard Type with Encoder

Standard Type with Electromagnetic Brake

Frame Size 28 mm (1.10 in.) (Bipolar 4 Lead Wires)

Specifications

Product Name	Maximum Holding Torque N·m (oz·in)	Rotor Inertia J: kg·m ² (oz·in ²)	Rated Current A/Phase	Voltage VDC	Winding Resistance Ω/Phase	Inductance mH/Phase	Basic Step Angle	Electromagnetic Brake Static Friction Torque N·m (oz·in)	Recommended Driver Product Name*2
PKP223D15□2	0.095 (13.4)	9×10 ⁻⁷ (0.049)	1.5	1.77	1.18	0.96	1.8°	-	CVD215BR-K
PKP225D15□2	0.19 (26)	18×10 ⁻⁷ (0.098)		3	2	1.6			
PKP223D15A2-R2E■	0.095 (13.4)	9.1×10 ⁻⁷ (0.05)		1.77	1.18	0.96			
PKP225D15A2-R2E■	0.19 (26)	18×10 ⁻⁷ (0.098)		3	2	1.6			
PKP223D15M2	0.095 (13.4)	14×10 ⁻⁷ *1 (0.077)		1.77	1.18	0.96			
PKP225D15M2	0.19 (26)	23×10 ⁻⁷ *1 (0.126)		3	2	1.6			
							0.08 (11.3)		

- The box □ in the product name indicates the shaft **A** (single shaft) or **B** (double shaft).
The box ■ in the product name indicates the encoder output circuit type **L** (line driver output). The voltage output type will have no "■" in the product name.
- See page 42 for electromagnetic brake specifications.
- See page 42 for encoder specifications.
- *1 The Inertia of the electromagnetic brake is included in the value.
- *2 See page 64 for details on the recommended drivers.

Speed – Torque Characteristics (Reference Values) fs: Max. Starting Frequency

PKP223D

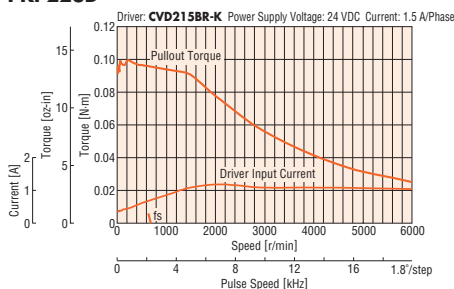

PKP225D

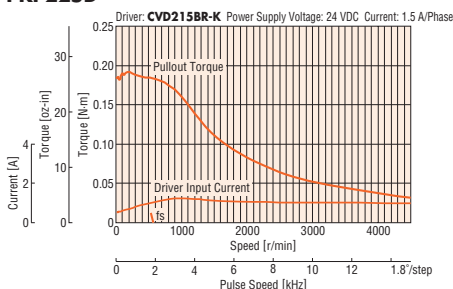

Note

- Data for the speed – torque characteristics is based on Oriental Motor's internal measurement conditions. If the conditions are changed, the characteristics may also change as a result.
- Depending on the driving conditions, a considerable amount of heat may be generated by the motor. Be sure to keep the temperature of the motor case under 100°C (212°F).
- For motors with encoders, to protect the encoder, keep the motor case temperature at 85°C (185°F) max.
- Set the current of the driver so that it does not exceed the rated current of the motor.

Dimensions Unit = mm (in.)

● Motor

Product Name	L1	L2	Mass kg (lb.)	CAD
PKP223D15A2	32	-	0.11	B980
PKP223D15B2	(1.26)	42 (1.65)	(0.24)	
PKP225D15A2	51.5	-	0.2	B982
PKP225D15B2	(2.03)	61.5 (2.42)	(0.44)	

- Motor Applicable Connector
Connector Housing: 51065-0600 (Molex)
Contact: 50212-8100 (Molex)
Crimp Tool: 63819-0500 (Molex)

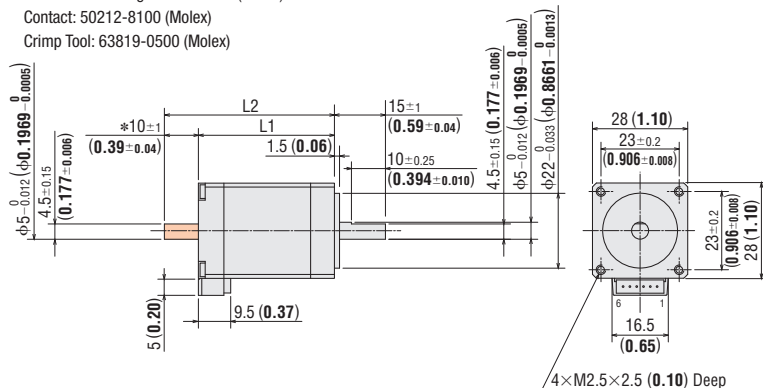

● Connection Cable (Sold Separately)

◇ Cable for Motor

- Bipolar 4 Lead Wires
LC2B06A

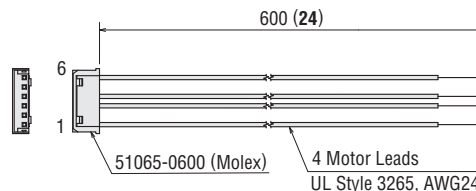

Inner Wiring Diagram of Motor

Wiring Diagram No.: Model B③

- Refer to page 44 for inner wiring diagram of motor.

- *The length of machining on the double shaft model is 10±0.25 (0.394±0.010).
- These dimensions are for double shaft products. For single shaft products, ignore the shaded areas.

● Motor with Encoder

Product Name	L	Mass kg (lb.)	CAD
PKP223D15A2-R2E	47.5 (1.87)	0.12 (0.26)	B1198
PKP225D15A2-R2E	67 (2.64)	0.21 (0.46)	B1199

● Applicable connector (Molex)

	Motor	Encoder
Connector Housing	51065-0600	51021-0800
Contact	50212-8100	50079-8100
Crimp Tool	57176-5000	57067-3000

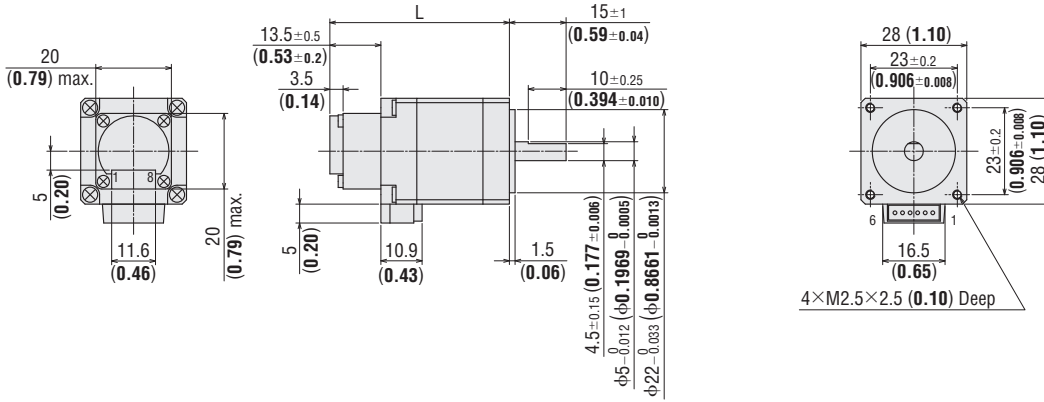

● Motor Connection Cable (Sold Separately)

Product Name	Length L m (ft.)
LC2B06A	0.6 (2)

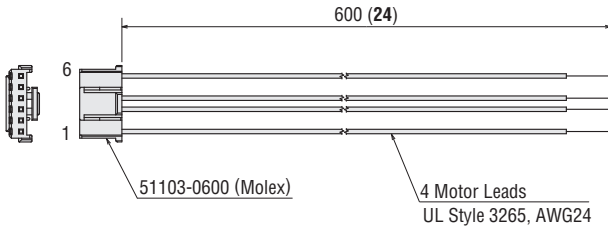

● Motor

Product Name	L	Mass kg (lb.)	CAD
PKP223D15M2	65.5 (2.58)	0.17 (0.37)	B1196
PKP225D15M2	85 (3.35)	0.26 (0.57)	B1197

● Applicable Connector (Molex)
 Connector Housing: 51065-0600
 Contact: 50212-8100
 Crimp Tool: 63819-0500

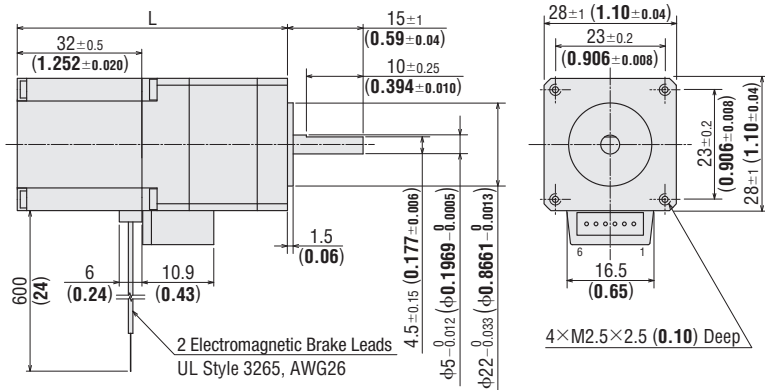

● Sold Separately
 Connection Cable
 Product Name: **LC2B06B**

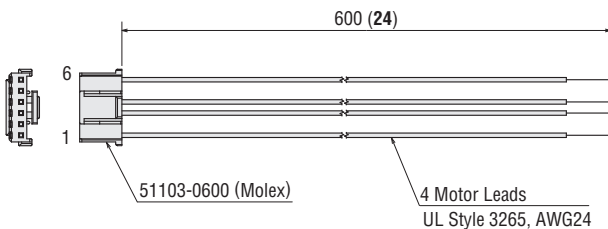

● Encoder Connection Cable (Sold Separately)

Product Name	Applicable Encoder	Length L m (ft.)
LCE05A-006	Voltage Output	0.6 (2)
LCE08A-006	Line Driver Output	0.6 (2)

◇ Voltage Output

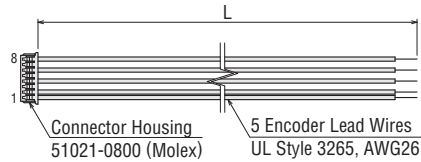

◇ Line Driver Output

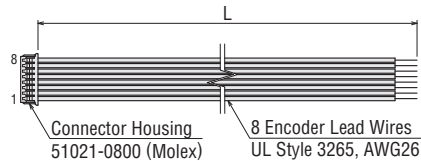

2-Phase
Motors
PKP

Features
Product
Line

Product
Number
Product Line

Standard
Type

High-
Resolution
Type

Flat Type

SH
Geared
Type

General
Specifications/
Inner Wiring
Diagram of Motor

5-Phase
Motors
PKP

Features
Product
Line

Product
Number
Product Line

Standard
Type

High-
Resolution
Type

TS
Geared
Type

General
Specifications/
Inner Wiring
Diagram of Motor

Driver for
2-Phase/
5-Phase Motors

Accessories

● Motor with Encoder

Product Name	L	Mass kg (lb.)	CAD
PKP233D15A-R2E	50.5 (1.99)	0.19 (0.42)	B1102
PKP235D15A-R2E	65.5 (2.57)	0.295 (0.65)	B1103

● Applicable connector (Molex)

	Motor	Encoder
Connector Housing	51103-0600	51021-0800
Contact	50351-8100	50079-8100
Crimp Tool	57295-5000	57067-3000

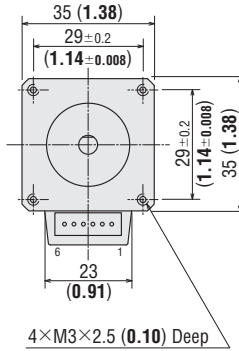
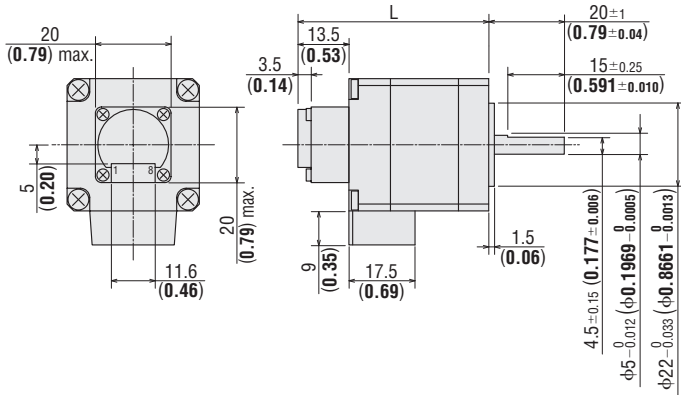

● Motor Connection Cable (Sold Separately)

Product Name	Length L m (ft.)
LC2B06B	0.6 (2)

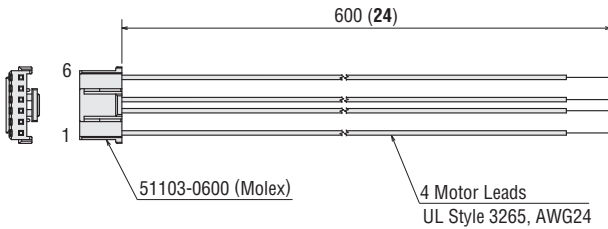

● Encoder Connection Cable (Sold Separately)

Product Name	Applicable Encoder	Length L m (ft.)
LCE05A-006	Voltage Output	0.6 (2)
LCE08A-006	Line Driver Output	0.6 (2)

◇ Voltage Output

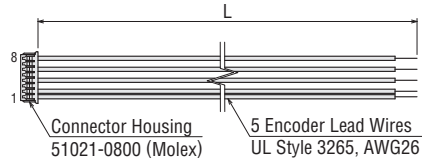

◇ Line Driver Output

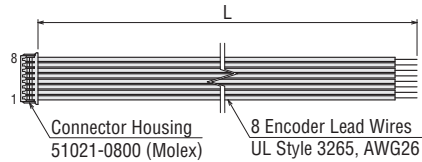

● Electromagnetic Brake Motor

Product Name	L	Mass kg (lb.)	CAD
PKP233D15M	71 (2.79)	0.285 (0.63)	B1134
PKP235D15M	86 (3.39)	0.39 (0.86)	B1135

● Applicable Connector (Molex)
 Connector Housing: 51103-0600
 Contact: 50351-8100
 Crimp Tool: 57295-5000

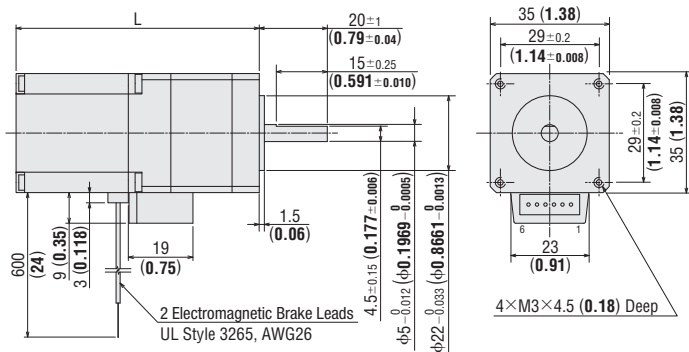

● Motor Connection Cable (Sold Separately)

Product Name	Length L m (ft.)
LC2B06B	0.6 (2)

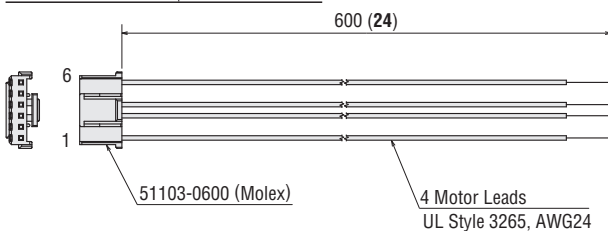

2-Phase
Motors
PKP

Features
Product
Line

Product
Number
Product Line

Standard
Type

High-
Resolution
Type

Flat Type

SH
Geared
Type

General
Specifications/
Inner Wiring
Diagram of Motor

5-Phase
Motors
PKP

Features
Product
Line

Product
Number
Product Line

Standard
Type

High-
Resolution
Type

TS
Geared
Type

General
Specifications/
Inner Wiring
Diagram of Motor

Driver for
2-Phase/
5-Phase Motors

Accessories

Standard Type Standard Type with Encoder

Frame Size 42 mm (1.65 in.) (Bipolar 4 Lead Wires)

20 mm (0.79 in.)

28 mm (1.10 in.)

35 mm (1.38 in.)

42 mm (1.65 in.)

50 mm (1.97 in.)

56.4 mm (2.22 in.)

60 mm (2.36 in.)

85 mm (3.35 in.)

Specifications

Product Name	Maximum Holding Torque	Rotor Inertia J: kg·m ² (oz·in ²)	Rated Current	Voltage	Winding Resistance	Inductance	Basic Step Angle	Recommended Driver Product Name*
	N·m (oz·in)		A/Phase	VDC	Ω/Phase	mH/Phase		
PKP243D08 □ 2	0.35 (49)	36×10 ⁻⁷ (0.197)	0.85	4.6	5.4	10	1.8°	CVD223FBR-K
PKP243D15 □ 2			1.5	2.7	1.8	3.3		
PKP243D23 □ 2			2.3	1.8	0.78	1.4		
PKP244D08 □ 2	0.48 (68)	54×10 ⁻⁷ (0.3)	0.85	5.7	6.7	14		
PKP244D15 □ 2			1.5	3.2	2.1	4.4		
PKP244D23 □ 2			2.3	2.1	0.93	1.9		
PKP245D08 □ 2	0.66 (93)	73×10 ⁻⁷ (0.4)	0.85	6	7.1	16		
PKP245D15 □ 2			1.5	3.3	2.2	5.3		
PKP245D23 □ 2			2.3	2.3	1	2.2		
PKP246D15 □ 2	0.99 (140)	110×10 ⁻⁷ (0.6)	1.5	4.4	2.9	7.9		
PKP246D23 □ 2			2.3	3.2	1.4	3.3		
PKP243D15A2-R2 ■	0.35 (49)	36×10 ⁻⁷ (0.2)	1.5	2.7	1.8	3.3		
PKP243D23A2-R2 ■			2.3	1.8	0.78	1.4		
PKP244D15A2-R2 ■			1.5	3.2	2.1	4.4		
PKP244D23A2-R2 ■	0.48 (68)	54×10 ⁻⁷ (0.3)	1.5	2.1	0.93	1.9		
PKP245D15A2-R2 ■			1.5	3.3	2.2	5.3		
PKP245D23A2-R2 ■			2.3	2.3	1	2.2		
PKP246D15A2-R2 ■	0.99 (140)	110×10 ⁻⁷ (0.6)	1.5	4.4	2.9	7.9		
PKP246D23A2-R2 ■			2.3	3.2	1.4	3.3		

- The box □ in the product name indicates the shaft **A** (single shaft) or **B** (double shaft).
- The box ■ in the product name indicates the encoder resolution **E** (200 P/R) or **F** (400 P/R).
- The box ■ in the product name indicates the encoder output circuit type **L** (line driver output). The voltage output type will have no "■" in the product name.
- See page 42 for encoder specifications.
- * See page 64 for details on the recommended drivers.

Speed – Torque Characteristics (Reference Values) *f_s*: Max. Starting Frequency

PKP243D08

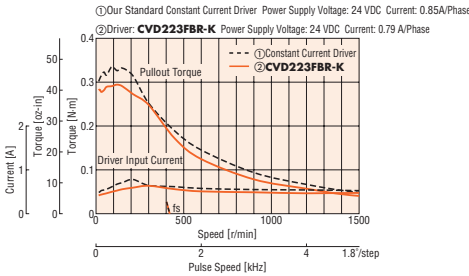

PKP243D15

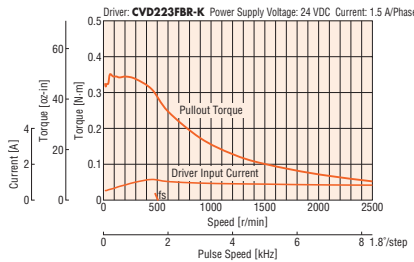

PKP243D23

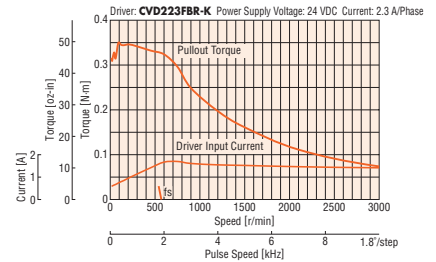

PKP244D08

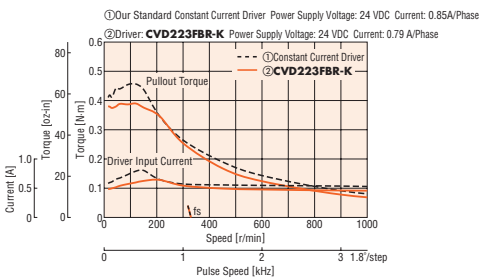

PKP244D15

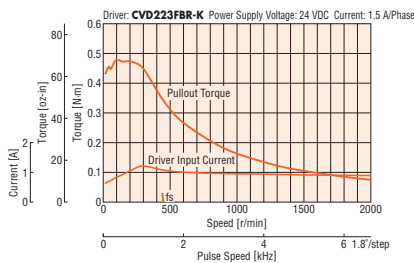

PKP244D23

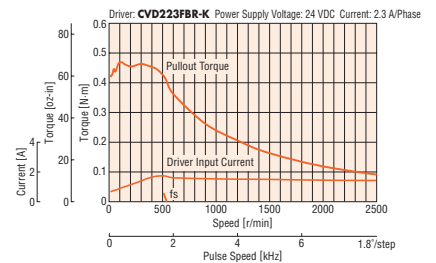

PKP245D08

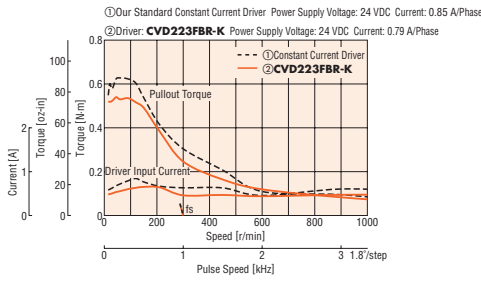

PKP245D15

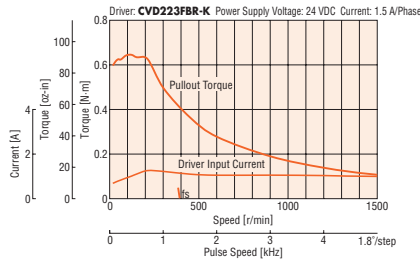

PKP245D23

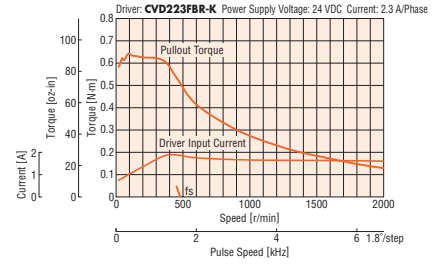

PKP246D15

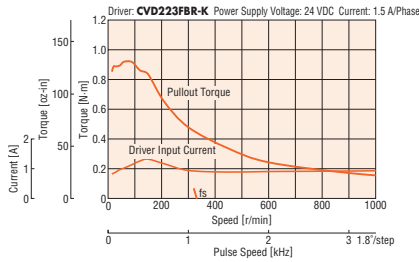

PKP246D23

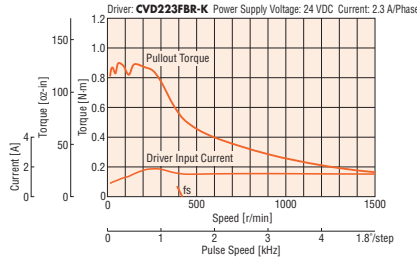

Note

- Data for the speed – torque characteristics is based on Oriental Motor's internal measurement conditions. If the conditions are changed, the characteristics may also change as a result.
- Depending on the driving conditions, a considerable amount of heat may be generated by the motor. Be sure to keep the temperature of the motor case under 100°C (212°F).
- For motors with encoders, to protect the encoder, keep the motor case temperature at 85°C (185°F) max.
- Set the current of the driver so that it does not exceed the rated current of the motor.

Dimensions Unit = mm (in.)

● Motors

2D & 3D CAD

Product Name	L1	L2	Mass kg (lb.)	CAD
PKP243D08A2	33 (1.30)	—	0.23 (0.51)	B1260
PKP243D08B2		48 (1.89)		
PKP243D15A2		—		
PKP243D15B2		48 (1.89)		
PKP243D23A2		—		
PKP243D23B2	48 (1.89)	—	0.3 (0.66)	B1261
PKP244D08A2	—			
PKP244D08B2	54 (2.13)			
PKP244D15A2	—			
PKP244D15B2	54 (2.13)			
PKP244D23A2	—	—	0.37 (0.82)	B1262
PKP244D23B2	54 (2.13)			
PKP245D08A2	—			
PKP245D08B2	62 (2.44)			
PKP245D15A2	47	—		
PKP245D15B2	(1.85)	62 (2.44)	0.5 (1.1)	B1263
PKP245D23A2	—			
PKP245D23B2	62 (2.44)			
PKP246D15A2	—			
PKP246D15B2	59	74 (2.91)		
PKP246D23A2	(2.32)	—	74 (2.91)	
PKP246D23B2	—	74 (2.91)	—	

● Applicable Connector

Connector Housing: MDF97-5S-3.5C (HIROSE ELECTRIC CO., LTD.)
 Contact: MDF97-22SC (HIROSE ELECTRIC CO., LTD.)
 Crimp Tool: HT801/MDF97-22S (HIROSE ELECTRIC CO., LTD.)

● Connection Cable (Sold Separately)

◇ Connection Cable for Motor

Product Name	Length L m (ft.)
LC2B06E	0.6 (2.2)

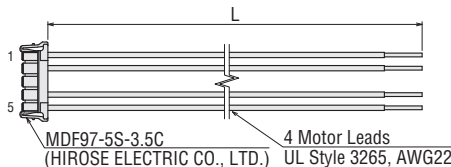

Inner Wiring Diagram of Motor

Wiring Diagram No.: Model A①

- Refer to page 44 for inner wiring diagram of motor.

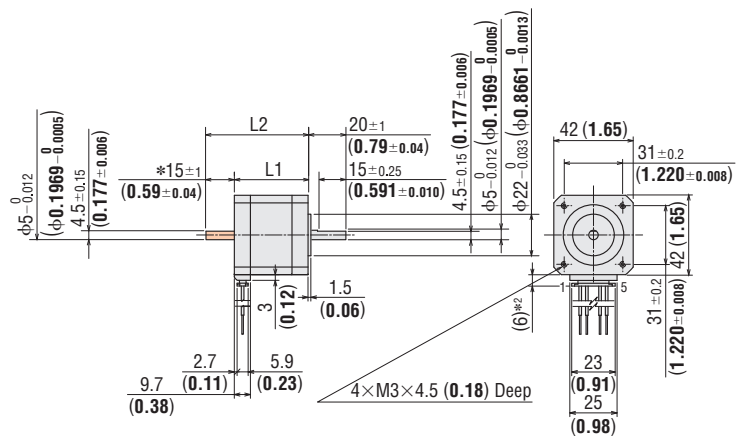

*1 The length of the shaft flat on the double shaft model is 15±0.25 (0.591±0.010).

*2 With connection cable

● These dimensions are for double shaft motors.

For single shaft motors, ignore the shaded areas.

2-Phase
Motors
PKP

Features
Product
Line

Product
Number
Product Line

Standard
Type

High-
Resolution
Type

Flat Type

SH
Geared
Type

General
Specifications/
Inner Wiring
Diagram of Motor

5-Phase
Motors
PKP

Features
Product
Line

Product
Number
Product Line

Standard
Type

High-
Resolution
Type

TS
Geared
Type

General
Specifications/
Inner Wiring
Diagram of Motor

Driver for
2-Phase/
5-Phase Motors

Accessories

Motor Frame Size

20 mm (0.79 in.)

28 mm (1.10 in.)

35 mm (1.38 in.)

42 mm (1.65 in.)

50 mm (1.97 in.)

56.4 mm (2.22 in.)

60 mm (2.36 in.)

85 mm (3.35 in.)

Dimensions Unit = mm (in.)

Motors

2D & 3D CAD

Product Name	L	Mass kg (lb.)	CAD
PKP243D15A2-R2E	46.5 (1.83)	0.24 (0.53)	B1321
PKP243D15A2-R2F			
PKP243D23A2-R2E			
PKP243D23A2-R2F	52.5 (2.07)	0.31 (0.68)	B1322
PKP244D15A2-R2E			
PKP244D15A2-R2F			
PKP244D23A2-R2E	60.5 (2.38)	0.38 (0.84)	B1323
PKP244D23A2-R2F			
PKP245D15A2-R2E			
PKP245D15A2-R2F	72.5 (2.85)	0.51 (1.12)	B1324
PKP245D23A2-R2E			
PKP245D23A2-R2F			
PKP246D15A2-R2E			
PKP246D15A2-R2F			
PKP246D23A2-R2E			
PKP246D23A2-R2F			

Applicable Connector

	Motor (HIROSE ELECTRIC CO., LTD.)	Encoder (Molex)
Connector Housing	MDF97-5S-3.5C	51021-0800
Contact	MDF97-22SC	50079-8100
Crimp Tool	HT801/MDF97-22S	57067-3000

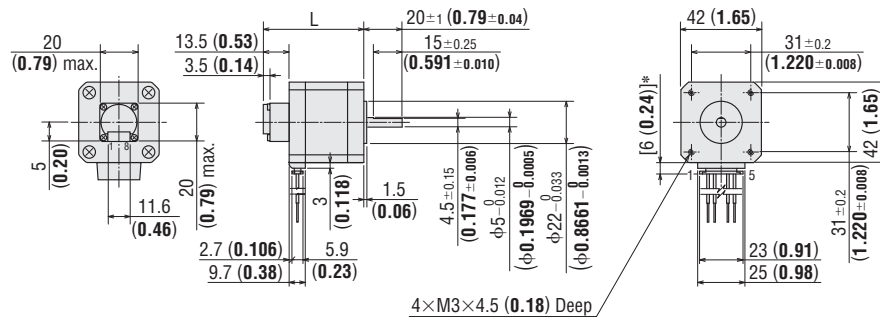

*With connection cable

Connection Cable (Sold separately)

Connection Cable for Motor

Product Name	Length L m (ft.)
LC2B06E	0.6 (2)

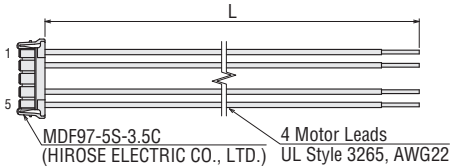

Encoder Connection Cable (Sold Separately)

Product Name	Applicable Encoder	Length L m (ft.)
LCE05A-006	Voltage Output	0.6 (2)
LCE08A-006	Line Driver Output	0.6 (2)

Voltage Output

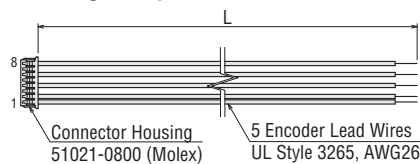

Line Driver Output

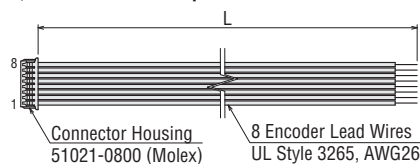

Inner Wiring Diagram of Motor

Wiring Diagram No.: Model A①

Refer to page 44 for inner wiring diagram of motor.

Standard Type with Electromagnetic Brake Frame Size 42 mm (1.65 in.) (Bipolar 4 Lead Wires)

2-Phase Motors PKP

Specifications

Product Name	Maximum Holding Torque N·m (oz·in)	Rotor Inertia J: kg·m ² (oz·in ²)	Rated Current A/Phase	Voltage VDC	Winding Resistance Ω/Phase	Inductance mH/Phase	Basic Step Angle	Electromagnetic Brake Static Friction Torque N·m (oz·in)
PKP243D15M	0.35 (49)	48 × 10 ⁻⁷ * (0.26)	1.5	2.85	1.9	5	1.8°	0.3 (42)
PKP244D15M	0.48 (68)	69 × 10 ⁻⁷ * (0.38)		3.9	2.6	4.9		
PKP245D15M	0.58 (82)	95 × 10 ⁻⁷ * (0.52)		3.6	2.4	6.6		
PKP246D15M	0.93 (132)	126 × 10 ⁻⁷ * (0.69)		5.8	3.87	8		

● See page 42 for electromagnetic brake specifications.
* The value includes the inertia of electromagnetic brake.

Speed – Torque Characteristics (Reference Values) *f_s*: Max. Starting Frequency

PKP243D15

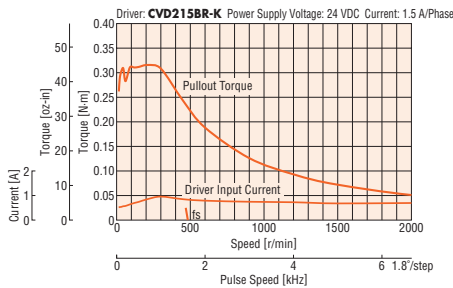

PKP244D15

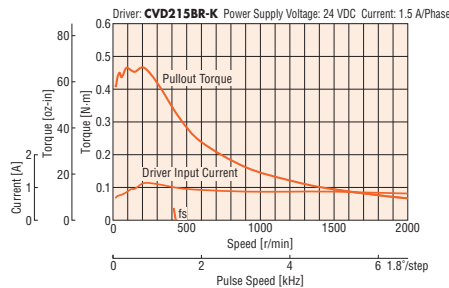

PKP245D15

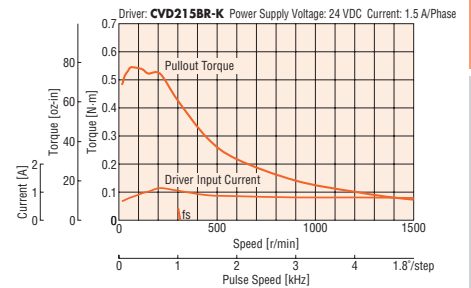

PKP246D15

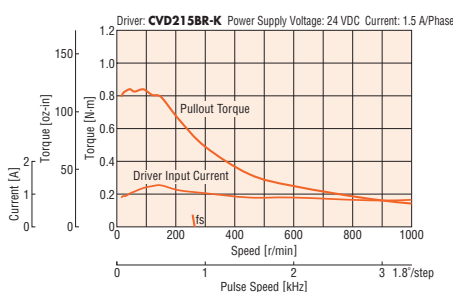

Note

- Data for the speed – torque characteristics is based on Oriental Motor's internal measurement conditions. If the conditions are changed, the characteristics may also change as a result.
- Depending on the driving conditions, a considerable amount of heat may be generated by the motor. Be sure to keep the temperature of the motor case under 100°C (212°F).
- Set the current of the driver so that it does not exceed the rated current of the motor.

Dimensions Unit = mm (in.)

● Motor with Electromagnetic Brake

Product Name	L	Mass kg (lb.)	CAD
PKP243D15M	67 (2.64)	0.36 (0.79)	B1136
PKP244D15M	73 (2.87)	0.41 (0.9)	B1137
PKP245D15M	81 (3.19)	0.5 (1.10)	B1138
PKP246D15M	93 (3.66)	0.61 (1.34)	B1139

● Applicable Connector (Molex)
Connector Housing: 51103-0600
Contact: 50351-8100
Crimp Tool: 57295-5000

● Motor Connection Cable (Sold Separately)

Product Name	Length L m (ft.)
LC2B06E	0.6 (2)

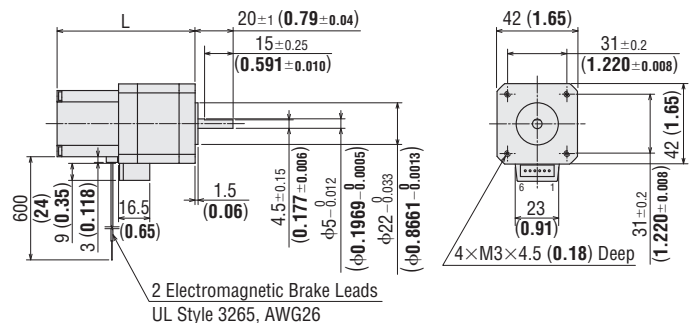
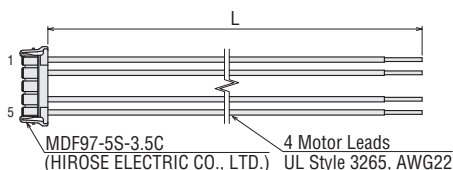

Inner Wiring Diagram of Motor

Wiring Diagram No.: Model B③

- Refer to page 44 for inner wiring diagram of motor.

Features Product Line

Product Number Product Line

Standard Type

High-Resolution Type

Flat Type

SH Geared Type

General Specifications/ Inner Wiring Diagram of Motor

5-Phase Motors PKP

Features Product Line

Product Number Product Line

Standard Type

High-Resolution Type

TS Geared Type

General Specifications/ Inner Wiring Diagram of Motor

Driver for 2-Phase/ 5-Phase Motors

Accessories

Standard Type Frame Size 50 mm (1.97 in.) (Unipolar 6 lead wires)

20 mm (0.79 in.)

28 mm (1.10 in.)

35 mm (1.38 in.)

42 mm (1.65 in.)

50 mm (1.97 in.)

56.4 mm (2.22 in.)

60 mm (2.36 in.)

85 mm (3.35 in.)

Specifications

Product Name	Max. Holding Torque N·m (oz·in)	Rotor Inertia J: kg·m ² (oz·in ²)	Rated Current A/Phase	Voltage VDC	Winding Resistance Ω/Phase	Inductance mH/Phase	Basic Step Angle	Recommended Driver Product Name*
PK256-02 □	0.6 (85)	230×10 ⁻⁷ (1.26)	1.4	4.2	3	5.6	1.8°	-
PK258-02 □	1.2 (170)	420×10 ⁻⁷ (2.3)		6.7	4.8	11.48		

- Either **A** (single shaft) or **B** (double shaft) indicating the configuration is specified where the box □ is located in the product name.
- For Bipolar performance, Yellow and White wires are not used.

Speed – Torque Characteristics (Reference values) fs: Max. Starting Frequency

PK256-02B Bipolar (Series)

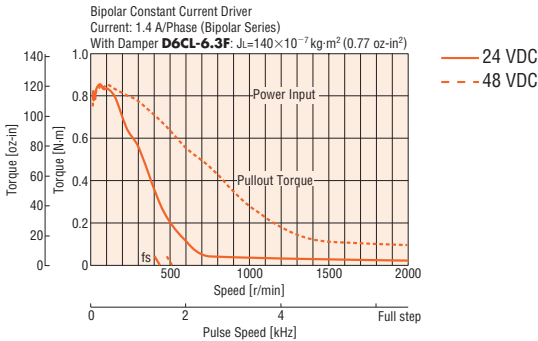

PK258-02B Bipolar (Series)

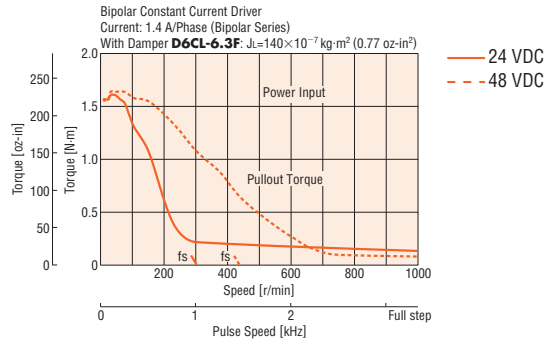

Note

- Data for the speed – torque characteristics is based on Oriental Motor's internal measurement conditions. If the conditions are changed, the characteristics may also change as a result.
- If there is a "clean damper" entry in the speed - torque characteristics, the data is for a double shaft motor when a clean damper is equipped.
- Depending on the driving conditions, a considerable amount of heat may be generated by the motor. Be sure to keep the motor case temperature at 100°C (212 °F) or less.
- Set the driver current to the rated current of the motor or lower.

Dimensions Unit = mm (in.)

Motors

2D & 3D CAD

Product Name	L1	L2	Mass kg (lb.)	CAD
PK256-02A	51.5 (2.03)	-	0.53 (1.17)	B293
PK256-02B	-	67.5 (2.66)	-	-
PK258-02A	81 (3.19)	-	0.89 (1.96)	B334
PK258-02B	-	97 (3.82)	-	-

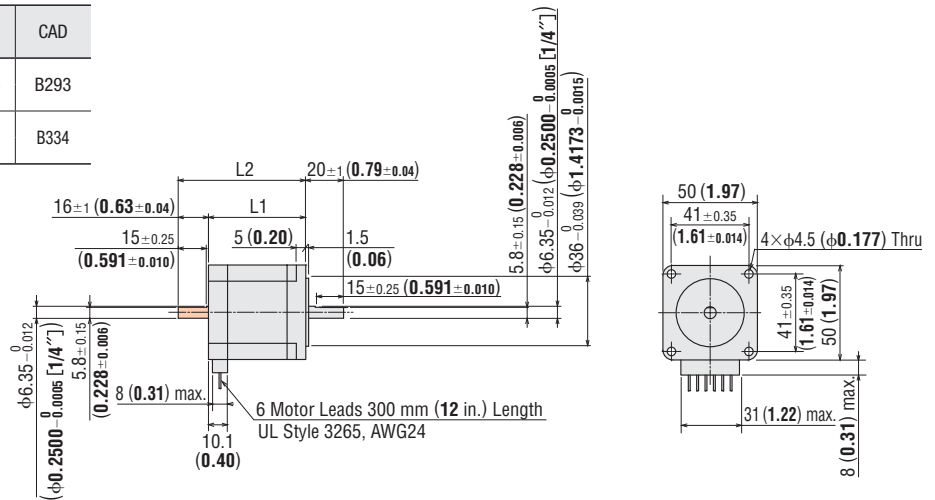

Inner Wiring Diagram of Motor

Wiring Diagram No.: Model C⑦

- Refer to page 44 for inner wiring diagram of motor.
- For Bipolar performance, refer to model C⑤. Yellow and White wires are not used.

Standard Type Standard Type with Encoder

Frame Size 56.4 mm (2.22 in.) (Bipolar 4 Lead Wires)

2-Phase
Motors
PKP

Features
Product
Line

Product
Number
Product Line

Standard
Type

High-
Resolution
Type

Flat Type

SH
Geared
Type

General
Specifications/
Inner Wiring
Diagram of Motor

5-Phase
Motors
PKP

Features
Product
Line

Product
Number
Product Line

Standard
Type

High-
Resolution
Type

TS
Geared
Type

General
Specifications/
Inner Wiring
Diagram of Motor

Driver for
2-Phase/
5-Phase Motors

Accessories

Specifications

Product Name	Maximum Holding Torque N·m (oz·in)	Rotor Inertia J: kg·m ² (oz·in ²)	Rated Current A/Phase	Voltage VDC	Winding Resistance Ω/Phase	Inductance mH/Phase	Basic Step Angle	Recommended Driver Product Name*
PKP264D14□A2	0.74 (105)	140×10 ⁻⁷ (0.77)	1.4	2.9	2.1	6	1.8°	CVD228BR-K
PKP264D28□A2			2.8	1.6	0.57	1.5		
PKP264D42□A2			4.2	1	0.24	0.65		
PKP266D14□A2	1.4 (198)	270×10 ⁻⁷ (1.48)	1.4	4.6	3.3	12		CVD228BR-K
PKP266D28□A2			2.8	2.4	0.86	2.9		CVD242BR-K
PKP266D42□A2			4.2	1.6	0.38	1.3		CVD242BR-K
PKP264D14A2-R2	0.74 (105)	140×10 ⁻⁷ (0.77)	1.4	2.9	2.1	6		CVD228BR-K
PKP264D28A2-R2			2.8	1.6	0.57	1.5		CVD242BR-K
PKP264D42A2-R2			4.2	1	0.24	0.65		CVD242BR-K
PKP266D14A2-R2	1.4 (198)	270×10 ⁻⁷ (1.48)	1.4	4.6	3.3	12		CVD228BR-K
PKP266D28A2-R2			2.8	2.4	0.86	2.9		CVD242BR-K
PKP266D42A2-R2			4.2	1.6	0.38	1.3		CVD242BR-K
PKP268D14A2-R2	2.5 (350)	500×10 ⁻⁷ (2.7)	1.4	6.6	4.7	18	CVD228BR-K	
PKP268D28A2-R2			2.8	3.4	1.2	4.6	CVD228BR-K	
PKP268D42A2-R2			4.2	2.2	0.53	2	CVD242BR-K	

● The box □ in the product name indicates the shaft **A** (single shaft) or **B** (double shaft).

The box □ in the product name indicates the encoder resolution **E** (200 P/R) or **F** (400 P/R).

The box ■ in the product name indicates the encoder output circuit type **L** (line driver output). The voltage output type will have no "■" in the product name.

● See page 42 for encoder specifications.

*See page 64 for details on the recommended drivers.

Speed – Torque Characteristics (Reference Values) *f_s*: Max. Starting Frequency

PKP264D14

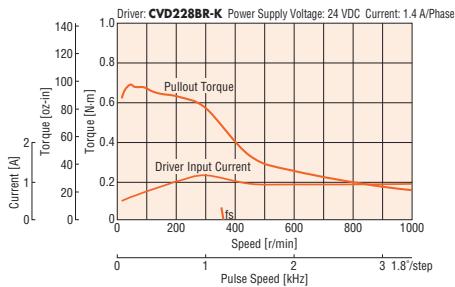

PKP264D28

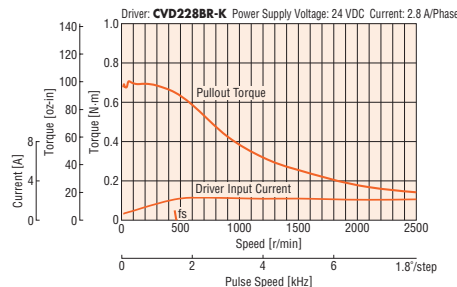

PKP264D42

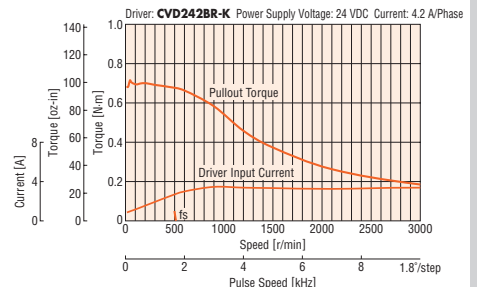

PKP266D14

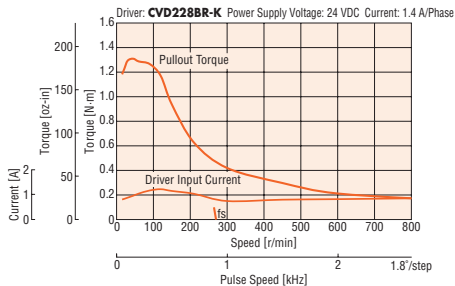

PKP266D28

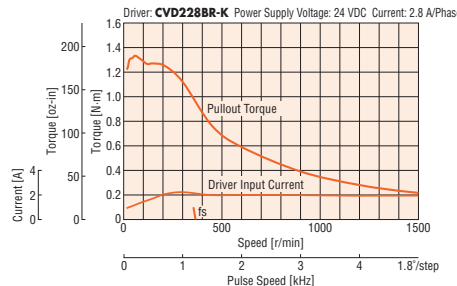

PKP266D42

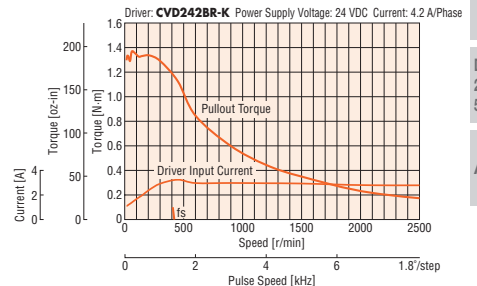

PKP268D14

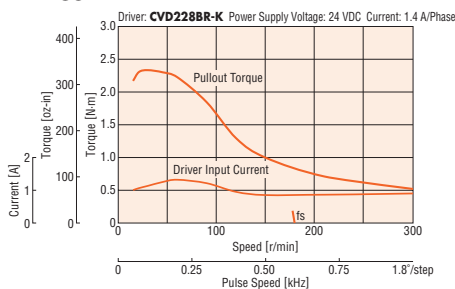

PKP268D28

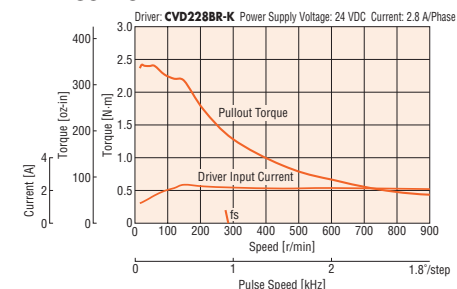

PKP268D42

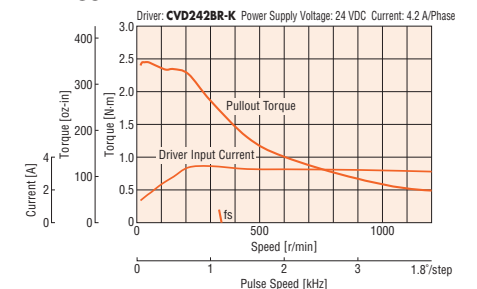

Note

- Data for the speed – torque characteristics is based on Oriental Motor's internal measurement conditions. If the conditions are changed, the characteristics may also change as a result.
- Depending on the driving conditions, a considerable amount of heat may be generated by the motor. Be sure to keep the temperature of the motor case under 100°C (212°F).
- For motors with encoders, to protect the encoder, keep the motor case temperature at 85°C (185°F) max.
- Set the current of the driver so that it does not exceed the rated current of the motor.

Standard Type with Electromagnetic Brake Frame Size 56.4 mm (2.22 in.) (Bipolar 4 Lead Wires)

2-Phase Motors
PKP

Specifications

Product Name	Maximum Holding Torque	Rotor Inertia J: kg·m ² (oz·in ²)	Rated Current A/Phase	Voltage VDC	Winding Resistance Ω/Phase	Inductance mH/Phase	Basic Step Angle	Electromagnetic Brake Static Friction Torque
	N·m (oz·in)							N·m (oz·in)
PKP264D28M	0.6 (85)	270 × 10 ⁻⁷ * (1.48)	2.8	2	0.73	1.8	1.8°	1.5 (213)
PKP266D28M	1.4 (198)	440 × 10 ⁻⁷ * (2.4)		2.8	1	2.9		
PKP268D28M	2.3 (320)	640 × 10 ⁻⁷ * (3.5)		3.4	1.23	4.4		

- See page 42 for electromagnetic brake specifications.
- *The value includes the inertia of electromagnetic brake.

Speed – Torque Characteristics (Reference Values) *f_s*: Max. Starting Frequency

PKP264D28

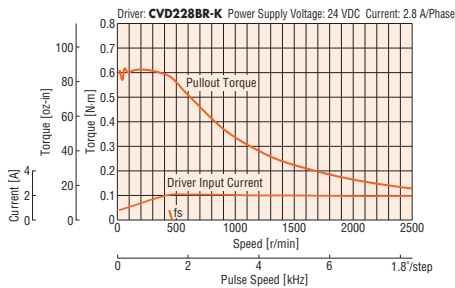

PKP266D28

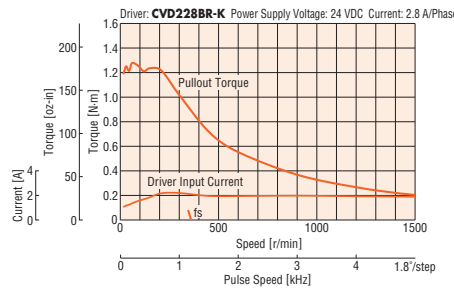

PKP268D28

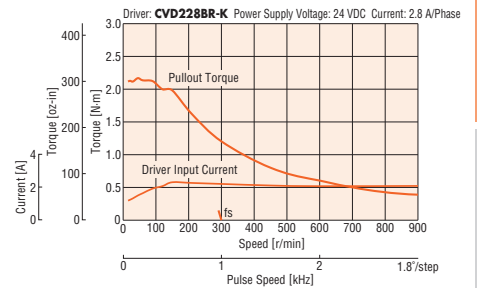

Note

- Data for the speed – torque characteristics is based on Oriental Motor's internal measurement conditions. If the conditions are changed, the characteristics may also change as a result.
- Depending on the driving conditions, a considerable amount of heat may be generated by the motor. Be sure to keep the temperature of the motor case under 100°C (212°F).
- Set the current of the driver so that it does not exceed the rated current of the motor.

Dimensions Unit = mm (in.)

● Motor with Electromagnetic Brake

Product Name	L	Mass kg (lb.)	CAD
PKP264D28M	75.5 (2.97)	0.76 (1.68)	B1140
PKP266D28M	90.5 (3.56)	1.03 (2.27)	B1141
PKP268D28M	112.5 (4.43)	1.4 (3.08)	B1142

- Applicable Connector (Molex)
Connector Housing: 51067-0600
Contact: 50217-9101
Crimp Tool: 57189-5000
57190-5000

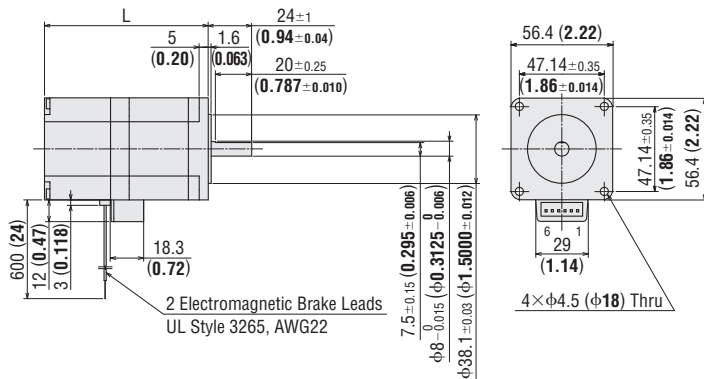

● Motor Connection Cable (Sold Separately)

Product Name	Length L m (ft.)
LC2B06C	0.6 (2)

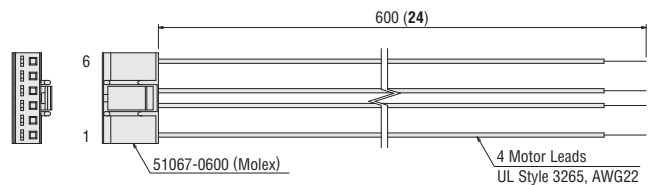

Inner Wiring Diagram of Motor

Wiring Diagram No.: Model B③

- Refer to page 44 for inner wiring diagram of motor.

Features
Product Line

Product Number
Product Line

Standard Type

High-Resolution Type

Flat Type

SH Geared Type

General Specifications/
Inner Wiring Diagram of Motor

5-Phase Motors
PKP

Features
Product Line

Product Number
Product Line

Standard Type

High-Resolution Type

TS Geared Type

General Specifications/
Inner Wiring Diagram of Motor

Driver for
2-Phase/
5-Phase Motors

Accessories

Standard Type

Frame Size 85 mm (3.35 in.) (Bipolar 4 Lead Wires)

20 mm
(0.79 in.)

28 mm
(1.10 in.)

35 mm
(1.38 in.)

42 mm
(1.65 in.)

50 mm
(1.97 in.)

56.4 mm
(2.22 in.)

60 mm
(2.36 in.)

85 mm
(3.35 in.)

Specifications

Product Name	Maximum Holding Torque	Rotor Inertia	Rated Current	Voltage	Winding Resistance	Inductance	Basic Step Angle	Recommended Driver Product Name*
	N·m (lb·in)							
PKP296D45 □A	3.3 (29)	1100×10 ⁻⁷ (6)	4.5	1.9	0.42	3.1	1.8°	CVD245BR-K
PKP296D63 □A			6.3	1.4	0.23	1.6		–
PKP299D45 □A	6.4 (56)	2200×10 ⁻⁷ (12)	4.5	2.7	0.6	5.4		CVD245BR-K
PKP299D63 □A			6.3	2	0.32	2.6		–
PKP2913D45 □A	9.5 (84)	3400×10 ⁻⁷ (18.6)	4.5	3.5	0.78	6.9		CVD245BR-K
PKP2913D56 □A			5.6	2.6	0.47	4.4		–

● The box □ in the product name indicates the shaft **A** (single shaft) or **B** (double shaft).

*See page 64 for details on the recommended drivers.

Speed – Torque Characteristics (Reference Values) fs: Max. Starting Frequency

PKP296D45

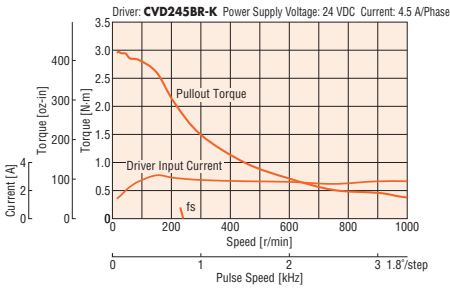

PKP296D63

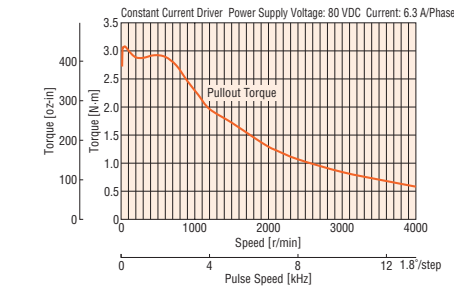

PKP299D45

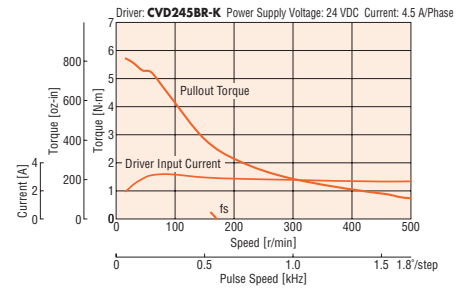

PKP299D63

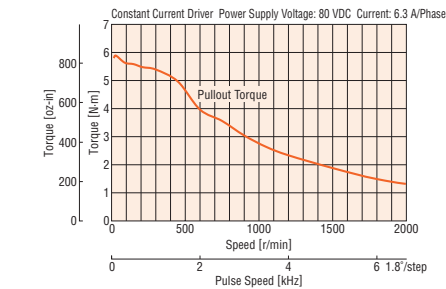

PKP2913D45

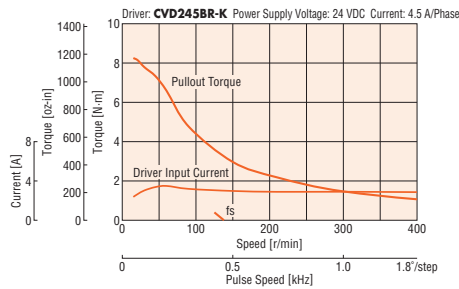

PKP2913D56

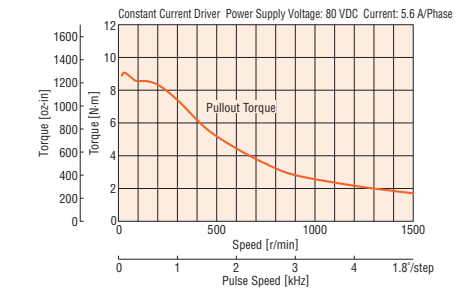

Note

- Data for the speed – torque characteristics is based on Oriental Motor's internal measurement conditions. If the conditions are changed, the characteristics may also change as a result.
- Depending on the driving conditions, a considerable amount of heat may be generated by the motor. Be sure to keep the temperature of the motor case under 100°C (212°F).
- Set the current of the driver so that it does not exceed the rated current of the motor.

Dimensions Unit = mm (in.)

Motor

Product Name	L1	L2	Mass kg (lb.)
PKP296D45AA	66 (2.60)	–	1.8 (3.97)
PKP296D45BA		100 (3.94)	
PKP296D63AA		–	
PKP296D63BA		100 (3.94)	
PKP299D45AA	96 (3.78)	–	2.9 (6.39)
PKP299D45BA		130 (5.12)	
PKP299D63AA		–	
PKP299D63BA		130 (5.12)	
PKP2913D45AA	126 (4.96)	–	4 (8.82)
PKP2913D45BA		160 (6.30)	
PKP2913D56AA		–	
PKP2913D56BA		160 (6.30)	

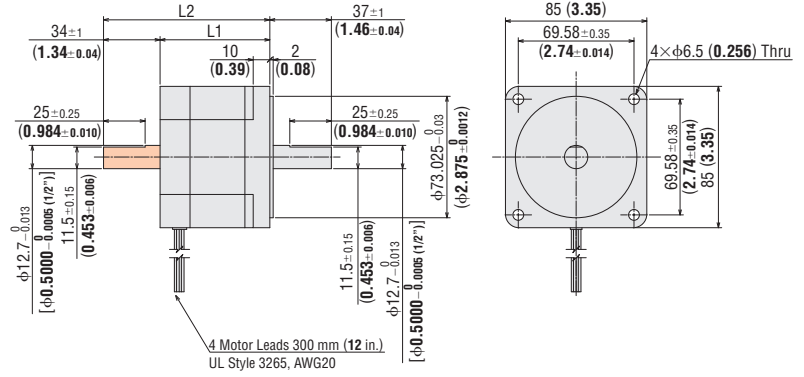

- These dimensions are for double shaft motors. For single shaft motors, ignore the shaded areas.

Inner Wiring Diagram of Motor

Wiring Diagram No.: Model C⑤

- Refer to page 44 for inner wiring diagram of motor.

2-Phase
Motors
PKP

Features
Product
Line

Product
Number
Product Line

Standard
Type

High-
Resolution
Type

Flat Type

SH
Geared
Type

General
Specifications/
Inner Wiring
Diagram of Motor

5-Phase
Motors
PKP

Features
Product
Line

Product
Number
Product Line

Standard
Type

High-
Resolution
Type

TS
Geared
Type

General
Specifications/
Inner Wiring
Diagram of Motor

Driver for
2-Phase/
5-Phase Motors

Accessories

Motor Frame Size

20 mm (0.79 in.)

28 mm (1.10 in.)

35 mm (1.38 in.)

42 mm (1.65 in.)

50 mm (1.97 in.)

56.4 mm (2.22 in.)

60 mm (2.36 in.)

85 mm (3.35 in.)

High-Resolution Type Frame Size 42 mm (1.65 in.) (Bipolar 4 Lead Wires)

High-Resolution Type with Encoder

High-Resolution Type with Electromagnetic Brake

Specifications

Product Name	Maximum Holding Torque N·m (oz·in)	Rotor Inertia J: kg·m ² (oz·in ²)	Rated Current A/Phase	Voltage VDC	Winding Resistance Ω/Phase	Inductance mH/Phase	Basic Step Angle	Electromagnetic Brake Static Friction Torque N·m (oz·in)	Recommended Driver Product Name*2
PKP243MD15□	0.30 (42)	36×10 ⁻⁷ (0.197)	1.5	2.85	1.9	6.6	0.9°	-	CVD215BR-K
PKP244MD15□	0.42 (59)	57×10 ⁻⁷ (0.31)		3.9	2.6	7.6			
PKP243MD15A-R2F■	0.30 (42)	36×10 ⁻⁷ (0.197)		2.85	1.9	6.6			
PKP244MD15A-R2F■	0.42 (59)	57×10 ⁻⁷ (0.31)		3.9	2.6	7.6			
PKP243MD15M	0.30 (42)	48×10 ⁻⁷ *1 (0.26)		2.85	1.9	6.6		0.3 (42)	-
PKP244MD15M	0.42 (59)	69×10 ⁻⁷ *1 (0.38)		3.9	2.6	7.6			

- The box □ in the product name indicates the shaft **A** (single shaft) or **B** (double shaft).
The box ■ in the product name indicates the encoder output circuit type **L** (line driver output). The voltage output type will have no "■" in the product name.
- See page 42 for electromagnetic brake specifications.
- See page 42 for encoder specifications.
- *1 The value includes the inertia of the electromagnetic brake.
- *2 See page 64 for details on the recommended drivers.

Speed – Torque Characteristics (Reference Values) fs: Max. Starting Frequency

PKP243MD

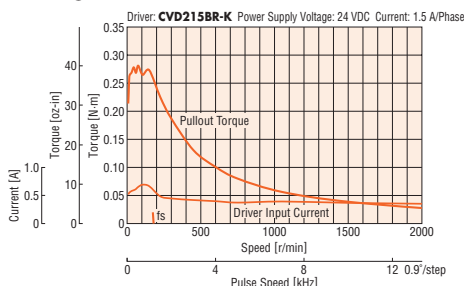

PKP244MD

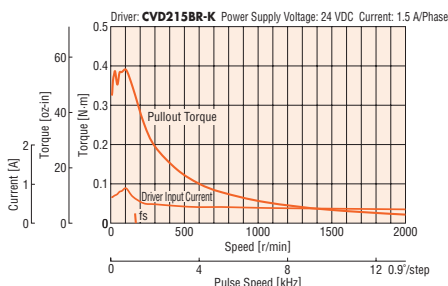

Note

- Data for the speed – torque characteristics is based on Oriental Motor's internal measurement conditions. If the conditions are changed, the characteristics may also change as a result.
- Depending on the driving conditions, a considerable amount of heat may be generated by the motor. Be sure to keep the temperature of the motor case under 100°C (212°F).
- For motors with encoders, to protect the encoder, keep the motor case temperature at 85°C (185°F) max.
- Set the current of the driver so that it does not exceed the rated current of the motor.

Dimensions Unit = mm (in.)

● Motor

Product Name	L1	L2	Mass kg (lb.)	CAD
PKP243MD15A-L	33 (1.30)	-	0.25 (0.55)	B968
PKP243MD15B-L	-	48 (1.89)		
PKP244MD15A-L	39	-	0.3 (0.66)	B969
PKP244MD15B-L	(1.54)	54 (2.13)		

● Connection Cable (Sold Separately)

- ◇ Cable for Motor
- Bipolar 4 Lead Wires
LC2B06B

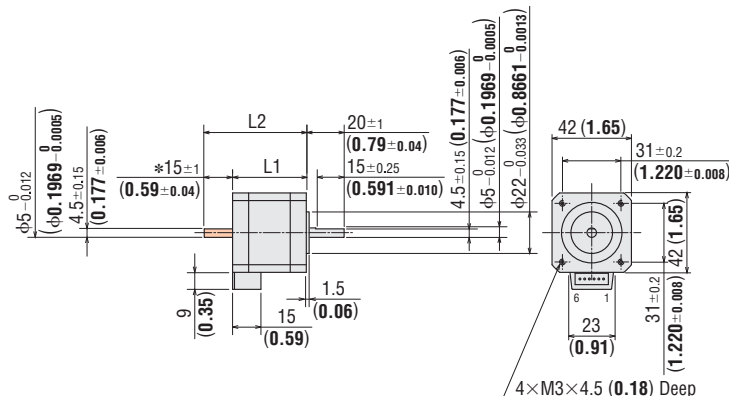
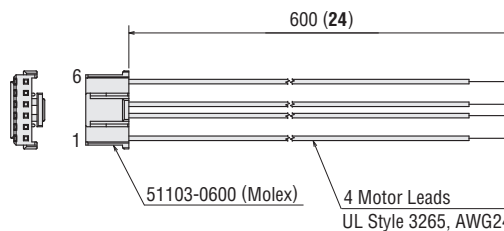

- *The length of machining on the double shaft product is 15±0.25 (0.591±0.010).
- These dimensions are for double shaft products. For single shaft products, ignore the shaded areas.
- Applicable Connector
Connector Housing: 51103-0600 (Molex)
Contact: 50351-8100 (Molex)
Crimp Tool: 63811-8100 (Molex)

Inner Wiring Diagram of Motor

Wiring Diagram No.: Model B③

- Refer to page 44 for inner wiring diagram of motor.

● Motor with Encoder

Product Name	L	Mass kg (lb.)	CAD
PKP243MD15A-R2F	46.5 (1.83)	0.26 (0.57)	B1104
PKP244MD15A-R2F	52.5 (2.07)	0.31 (0.68)	B1105

● Applicable connector (Molex)

	Motor	Encoder
Connector Housing	51103-0600	51021-0800
Contact	50351-8100	50079-8100
Crimp Tool	57295-5000	57067-3000

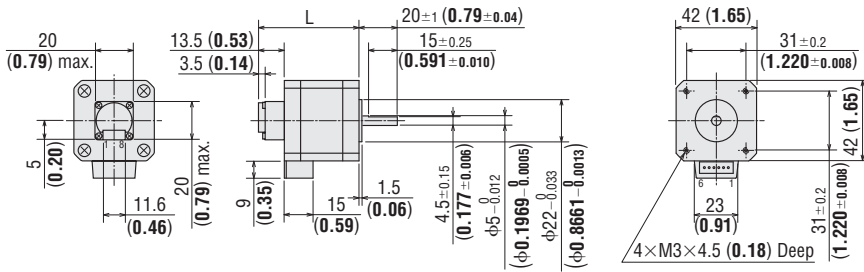

● Motor Connection Cable (Sold Separately)

Product Name	Length L m (ft.)
LC2B06B	0.6 (2)

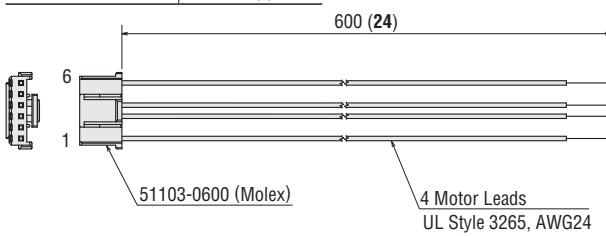

● Encoder Connection Cable (Sold Separately)

Product Name	Applicable Encoder	Length L m (ft.)
LCE05A-006	Voltage Output	0.6 (2)
LCE08A-006	Line Driver Output	0.6 (2)

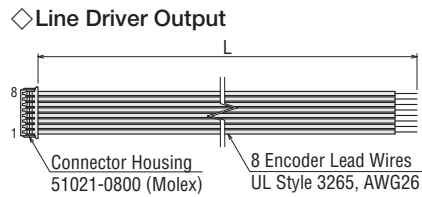
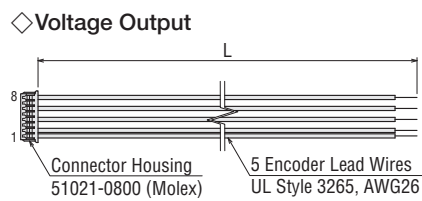

● Motor with Electromagnetic Brake

Product Name	L	Mass kg (lb.)	CAD
PKP243MD15M	67 (2.64)	0.36 (0.79)	B1136
PKP244MD15M	73 (2.87)	0.41 (0.9)	B1137

● Applicable Connector (Molex)
 Connector Housing: 51103-0600
 Contact: 50351-8100
 Crimp Tool: 57295-5000

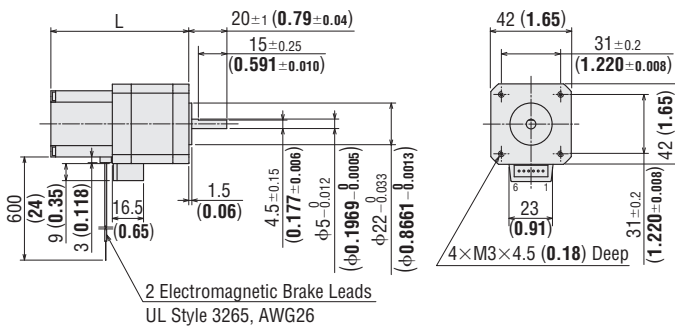

● Motor Connection Cable (Sold Separately)

Product Name	Length L m (ft.)
LC2B06B	0.6 (2)

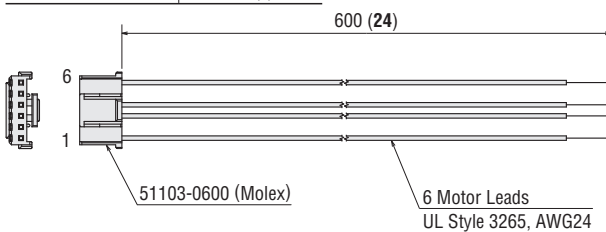

2-Phase
Motors
PKP

Features
Product
Line

Product
Number
Product Line

Standard
Type

High-
Resolution
Type

Flat Type

SH
Geared
Type

General
Specifications/
Inner Wiring
Diagram of Motor

5-Phase
Motors
PKP

Features
Product
Line

Product
Number
Product Line

Standard
Type

High-
Resolution
Type

TS
Geared
Type

General
Specifications/
Inner Wiring
Diagram of Motor

Driver for
2-Phase/
5-Phase Motors

Accessories

Motor Frame Size

20 mm (0.79 in.)

28 mm (1.10 in.)

35 mm (1.38 in.)

42 mm (1.65 in.)

50 mm (1.97 in.)

56.4 mm (2.22 in.)

60 mm (2.36 in.)

85 mm (3.35 in.)

High-Resolution Type Frame Size 56.4 mm (2.22 in.) (Bipolar 4 Lead Wires)

High-Resolution Type with Encoder

High-Resolution Type with Electromagnetic Brake

Specifications

Product Name	Maximum Holding Torque N·m (oz·in)	Rotor Inertia J: kg·m ² (oz·in ²)	Rated Current A/Phase	Voltage VDC	Winding Resistance Ω/Phase	Inductance mH/Phase	Basic Step Angle	Electromagnetic Brake Static Friction Torque N·m (oz·in)	Recommended Driver Product Name*2
PKP264MD28□A	0.6 (85)	120×10 ⁻⁷ (0.66)	2.8	2	0.73	2.1	0.9°	-	CVD228BR-K
PKP266MD28□A	1.32 (187)	290×10 ⁻⁷ (1.59)		2.8	1	3.9			
PKP268MD28□A	2.23 (316)	490×10 ⁻⁷ (2.7)		3.4	1.23	5.6			
PKP264MD28A-R2F■	0.6 (85)	120×10 ⁻⁷ (0.66)		2	0.73	2.1			
PKP266MD28A-R2F■	1.32 (187)	290×10 ⁻⁷ (1.59)		2.8	1	3.9			
PKP268MD28A-R2F■	2.23 (316)	490×10 ⁻⁷ (2.7)		3.4	1.23	5.6			
PKP264MD28M	0.6 (85)	270×10 ⁻⁷ *1 (1.48)		2	0.73	2.1	1.5 (213)	-	
PKP266MD28M	1.32 (187)	440×10 ⁻⁷ *1 (2.4)		2.8	1	3.9			
PKP268MD28M	2.23 (316)	640×10 ⁻⁷ *1 (3.5)		3.4	1.23	5.6			

- The box □ in the product name indicates the shaft **A** (single shaft) or **B** (double shaft).
- The box ■ in the product name indicates the encoder output circuit type **L** (line driver output). The voltage output type will have no "■" in the product name.
- See page 42 for electromagnetic brake specifications.
- See page 42 for encoder specifications.
- *1 The Inertia of the electromagnetic brake is included in the value.
- *2 See page 64 for details on the recommended drivers.

Speed – Torque Characteristics (Reference Values) fs: Max. Starting Frequency

PKP264MD

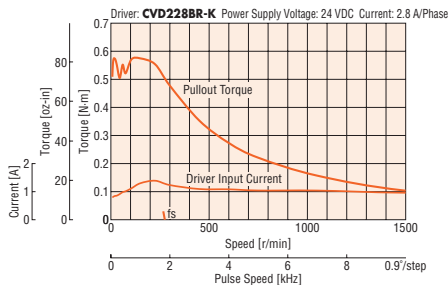

PKP266MD

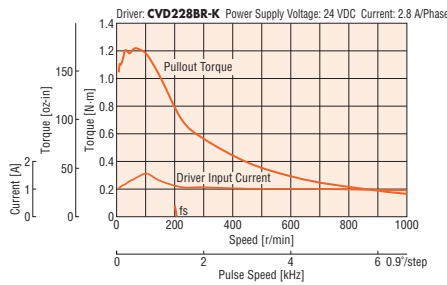

PKP268MD

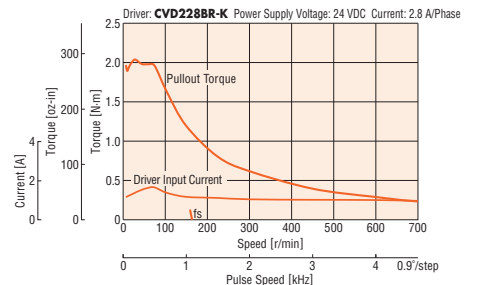

Note

- Data for the speed – torque characteristics is based on Oriental Motor's internal measurement conditions. If the conditions are changed, the characteristics may also change as a result.
- Depending on the driving conditions, a considerable amount of heat may be generated by the motor. Be sure to keep the temperature of the motor case under 100°C (212°F).
- For motors with encoders, to protect the encoder, keep the motor case temperature at 85°C (185°F) max.
- Set the current of the driver so that it does not exceed the rated current of the motor.

Dimensions Unit = mm (in.)

● Motor

Product Name	L1	L2	Mass kg (lb.)	CAD
PKP264MD14AA	-	-	-	B1028
PKP264MD14BA	39 (1.54)	55 (2.17)	0.46 (1.01)	
PKP264MD28AA	-	55 (2.17)	-	
PKP266MD14AA	-	-	-	B1029
PKP266MD14BA	54 (2.13)	70 (2.76)	0.73 (1.61)	
PKP266MD28AA	-	70 (2.76)	-	
PKP268MD14AA	-	-	-	B1030
PKP268MD14BA	76 (2.99)	92 (3.62)	1.1 (2.40)	
PKP268MD28AA	-	92 (3.62)	-	

● Connection Cable (Sold Separately)

◇ Cable for Motor

- Bipolar 4 Lead Wires
- LC2B06C

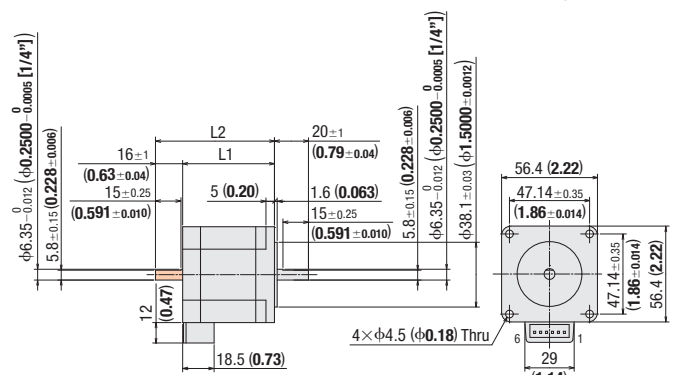
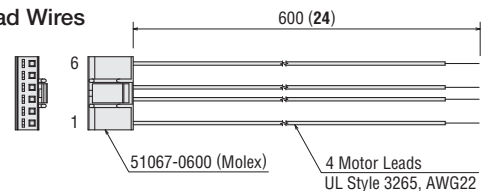

● These dimensions are for double shaft products. For single shaft products, ignore the shaded areas.

Encoder Motor

Product Name	L	Mass kg (lb.)	CAD
PKP264MD28A-R2F	55.5 (2.18)	0.47 (1.04)	B1108
PKP266MD28A-R2F	70.5 (2.78)	0.74 (1.63)	B1109
PKP268MD28A-R2F	92.5 (3.64)	1.11 (2.45)	B1110

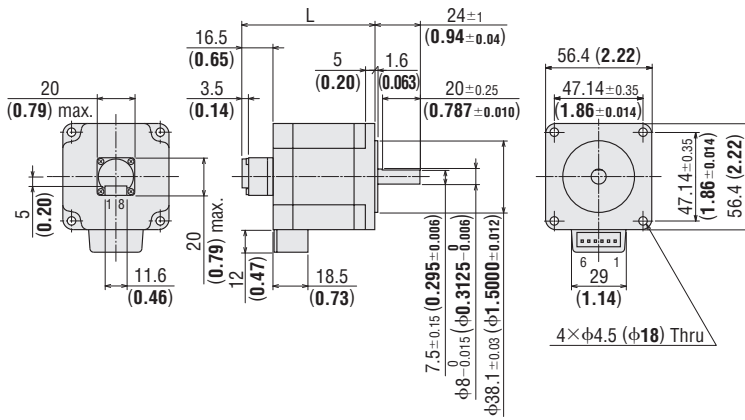

● Applicable connector (Molex)

	Motor	Encoder
Connector Housing	51067-0600	51021-0800
Contact	50217-9101	50079-8100
Crimp Tool	57189-5000 57190-5000	57067-3000

Motor Connection Cable (Sold Separately)

Product Name	Length L m (ft.)
LC2B06C	0.6 (2)

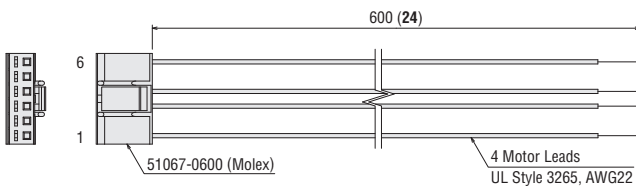

Electromagnetic Brake Motor

Product Name	L	Mass kg (lb.)	CAD
PKP264MD28M	75.5 (2.97)	0.76 (1.68)	B1140
PKP266MD28M	90.5 (3.56)	1.03 (2.27)	B1141
PKP268MD28M	112.5 (4.43)	1.4 (3.08)	B1142

● Applicable Connector (Molex)
 Connector Housing: 51067-0600
 Contact: 50217-9101
 Crimp Tool: 57189-5000
 57190-5000

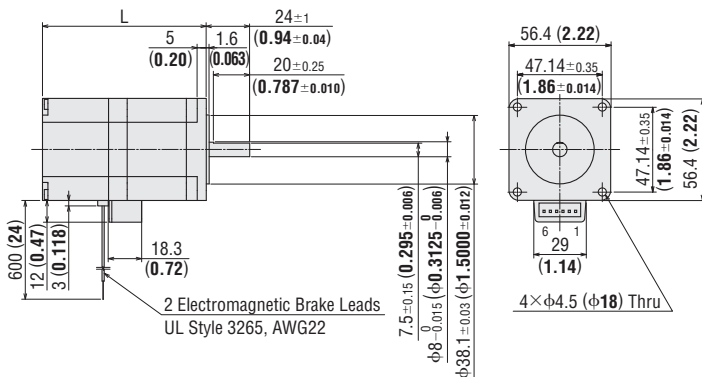

Motor Connection Cable (Sold Separately)

Product Name	Length L m (ft.)
LC2B06C	0.6 (2)

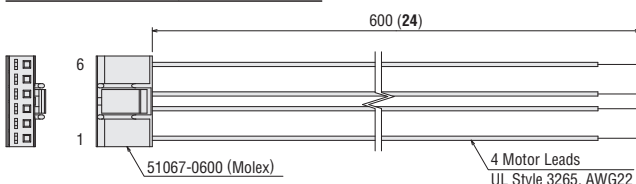

Encoder Connection Cable (Sold Separately)

Product Name	Applicable Encoder	Length L m (ft.)
LCE05A-006	Voltage Output	0.6 (2)
LCE08A-006	Line Driver Output	0.6 (2)

◇ Voltage Output

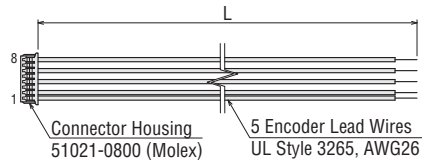

◇ Line Driver Output

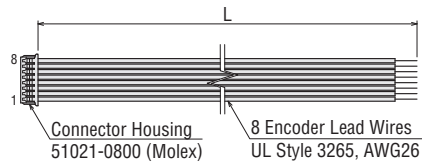

2-Phase
Motors
PKP

Features
Product
Line

Product
Number
Product Line

Standard
Type

High-
Resolution
Type

Flat Type

SH
Geared
Type

General
Specifications/
Inner Wiring
Diagram of Motor

5-Phase
Motors
PKP

Features
Product
Line

Product
Number
Product Line

Standard
Type

High-
Resolution
Type

TS
Geared
Type

General
Specifications/
Inner Wiring
Diagram of Motor

Driver for
2-Phase/
5-Phase Motors

Accessories

Flat Type

Frame Size 42 mm (1.65 in.) (Bipolar 4 lead wires)

20 mm
(0.79 in.)

28 mm
(1.10 in.)

35 mm
(1.38 in.)

42 mm
(1.65 in.)

50 mm
(1.97 in.)

56.4 mm
(2.22 in.)

60 mm
(2.36 in.)

85 mm
(3.35 in.)

Specifications

Product Name	Max. Holding Torque N·m (oz·in)	Rotor Inertia J: kg·m ² (oz·in ²)	Rated Current A/Phase	Voltage VDC	Winding Resistance Ω/Phase	Inductance mH/Phase	Basic Step Angle	Recommended Driver Product Name*
PKP242D23A2	0.1 (14.2)	13×10 ⁻⁷ (0.71)	2.3	1.4	0.61	0.53	1.8°	CVD223FBR-K

*Refer to page 64 for details on the recommended driver.

Speed – Torque Characteristics (Reference values) fs: Max. Starting Frequency

PKP242D23A2

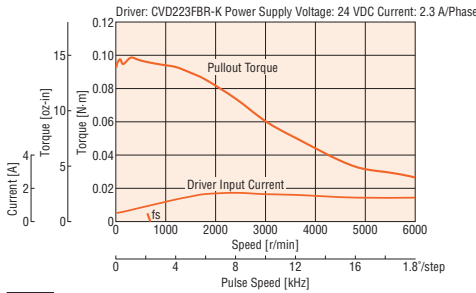

Note

- Data for the speed – torque characteristics is based on Oriental Motor's internal measurement conditions. If the conditions are changed, the characteristics may also change as a result.
- Depending on the driving conditions, a considerable amount of heat may be generated by the motor. Be sure to keep the motor case temperature at 100°C (212°F) or less.
- Set the rated current of the driver to a value lower than the motor rated current.

Dimensions Unit = mm (in.)

Motor

2D & 3D CAD

Product Name	Mass kg (lb.)	2D CAD
PKP242D23A2	0.11 (0.24)	B1355

Applicable Connector

Connector Housing: MDF97-5S-3.5C (HIROSE ELECTRIC CO., LTD.)
Contact: MDF97-22SC (HIROSE ELECTRIC CO., LTD.)
Crimp Tool: HT801/MDF97-22S (HIROSE ELECTRIC CO., LTD.)

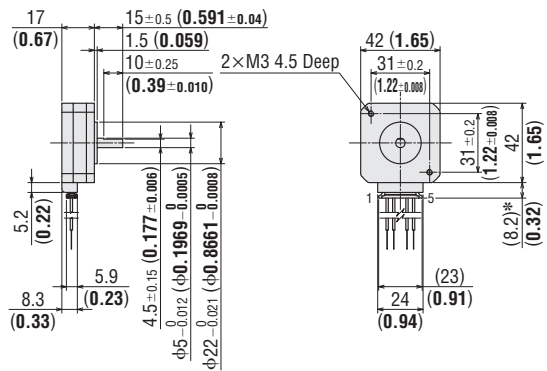

*With connection cable

Connection Cable (Sold separately)

◇ Connection Cable for Motor

LC2B06E

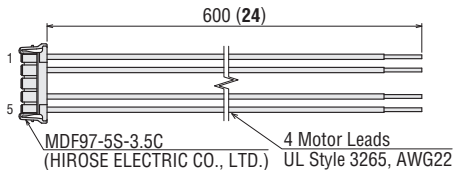

Inner Wiring Diagram of Motor

Wiring Diagram No.: Model A①

- Refer to page 44 for inner wiring diagram of motor.

Flat Type

Frame Size 60 mm (2.36 in.) (Bipolar 4 lead wires)

2-Phase
Motors
PKP

Specifications

Product Name	Max. Holding Torque N·m (oz·in)	Rotor Inertia J: kg·m ² (oz·in ²)	Rated Current A/Phase	Voltage VDC	Winding Resistance Ω/Phase	Inductance mH/Phase	Basic Step Angle	Recommended Driver Product Name*
PKP262FD15AW	0.18 (25.5)	68×10^{-7} (0.37)	1.5	2.25	1.5	1.4	1.8°	CVD215BR-K

* Refer to page 64 for details on the recommended driver.

Speed – Torque Characteristics (Reference values) fs: Max. Starting Frequency

PKP262FD15AW

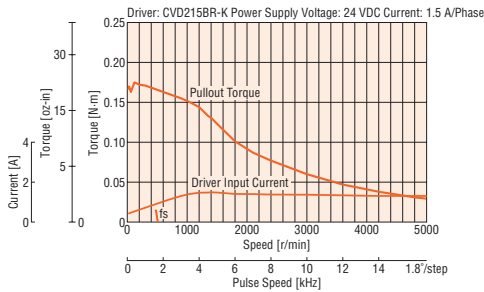

Note

- Data for the speed – torque characteristics is based on Oriental Motor's internal measurement conditions. If the conditions are changed, the characteristics may also change as a result.
- Depending on the driving conditions, a considerable amount of heat may be generated by the motor. Be sure to keep the motor case temperature at 100°C (212°F) or less.
- Set the driver current to the rated current of the motor or lower.

Dimensions Unit = mm (in.)

Motors

2D & 3D CAD

Product Name	Mass kg (lb.)	2D CAD
PKP262FD15AW	0.2 (0.44)	B1170

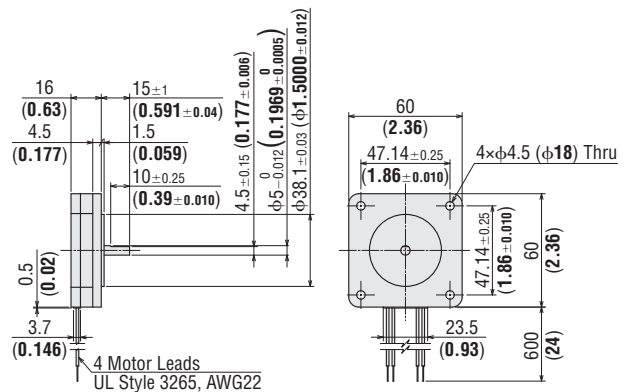

Inner Wiring Diagram of Motor

Wiring Diagram No.: Model C⑤

- Refer to page 44 for inner wiring diagram of motor.

Features
Product
Line

Product
Number
Product Line

Standard
Type

High-
Resolution
Type

Flat Type

SH
Geared
Type

General
Specifications/
Inner Wiring
Diagram of Motor

5-Phase
Motors
PKP

Features
Product
Line

Product
Number
Product Line

Standard
Type

High-
Resolution
Type

TS
Geared
Type

General
Specifications/
Inner Wiring
Diagram of Motor

Driver for
2-Phase/
5-Phase Motors

Accessories

SH Geared Type

Frame Size 28 mm (1.10 in.) (Bipolar 4 Lead Wires)

20 mm (0.79 in.)

28 mm (1.10 in.)

35 mm (1.38 in.)

42 mm (1.65 in.)

50 mm (1.97 in.)

56.4 mm (2.22 in.)

60 mm (2.36 in.)

85 mm (3.35 in.)

Specifications

Product Name	Maximum Holding Torque N·m (oz·in)	Rotor Inertia J: kg·m ² (oz·in ²)	Rated Current A/Phase	Voltage VDC	Winding Resistance Ω/Phase	Inductance mH/Phase	Basic Step Angle	Gear Ratio	Permissible Torque N·m (oz·in)	Speed Range r/min	Backlash arcmin	Recommended Driver Product Name*
PKP223D15 □- SG7.2	0.3 (42)	9×10 ⁻⁷ (0.049)	1.5	1.8	1.2	0.74	0.25°	7.2	0.3 (42)	0 - 416	90 (1.5°)	CVD215BR-K
0.2°							9	0 - 333				
0.18°	10						0 - 300					
0.1°	18						0 - 166					
0.05°	36						0 - 83					
PKP223D15 □- SG9												
PKP223D15 □- SG10												
PKP223D15 □- SG18	0.4 (56)											
PKP223D15 □- SG36												

● The box □ in the product name indicates the shaft **A** (single shaft) or **B** (double shaft).

*See page 64 for details on the recommended drivers.

Speed – Torque Characteristics (Reference Values) fs: Max. Starting Frequency

PKP223D Gear Ratio: 7.2

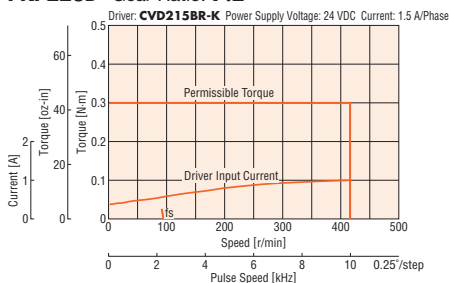

PKP223D Gear Ratio: 9

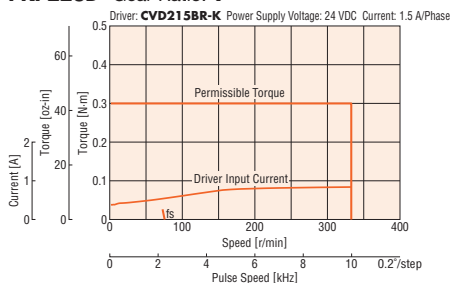

PKP223D Gear Ratio: 10

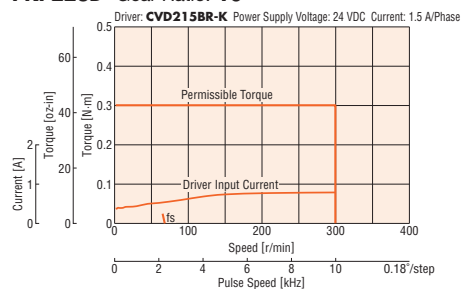

PKP223D Gear Ratio: 18

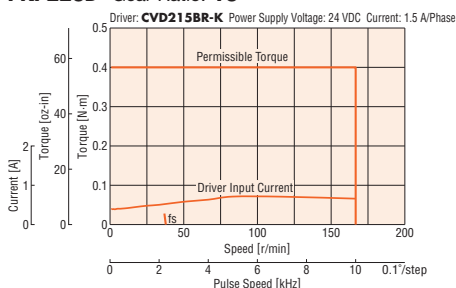

PKP223D Gear Ratio: 36

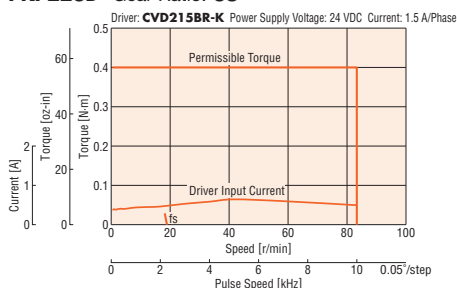

Note

- Data for the speed – torque characteristics is based on Oriental Motor's internal measurement conditions. If the conditions are changed, the characteristics may also change as a result.
- Depending on the driving conditions, a considerable amount of heat may be generated by the motor. Be sure to keep the temperature of the motor case under 100°C (212°F).
- Set the current of the driver so that it does not exceed the rated current of the motor.

Inner Wiring Diagram of Motor

Wiring Diagram No.: Model B③

- Refer to page 44 for inner wiring diagram of motor.

Dimensions Unit = mm (in.)

● Gearmotor

Product Name	Gear Ratio	Mass kg (lb.)	CAD
PKP223D06A-SG <input type="checkbox"/>	7.2, 9, 10, 18, 36	0.16 (0.35)	B985
PKP223D06B-SG <input type="checkbox"/>			
PKP223D15A-SG <input type="checkbox"/>			
PKP223D15B-SG <input type="checkbox"/>			

● Enter the gear ratio in the box within the product name.

● Applicable Connector

Connector Housing: 51065-0600 (Molex)
 Contact: 50212-8100 (Molex)
 Crimp Tool: 63819-0500 (Molex)

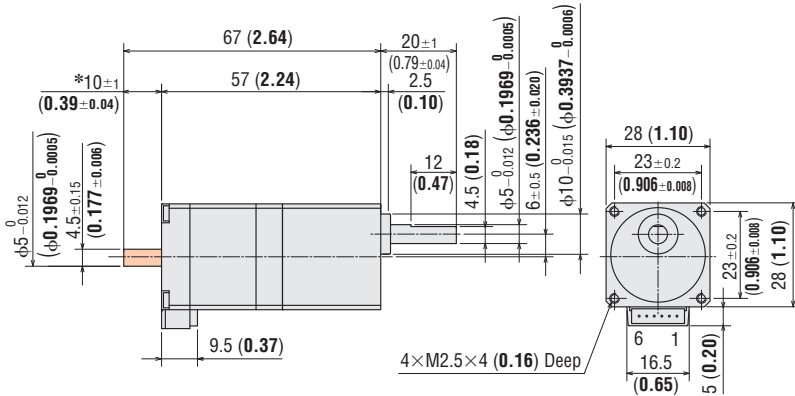

*The length of machining on the double shaft product is 10 ± 0.25 (0.394 ± 0.010).

● These dimensions are for double shaft products.
 For single shaft products, ignore the areas.

● Connection Cable (Sold Separately)

◇ Cable for Motor

- Bipolar 4 Lead Wires
LC2B06A

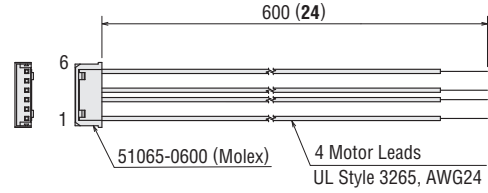

2-Phase
Motors
PKP

Features
Product
Line

Product
Number
Product Line

Standard
Type

High-
Resolution
Type

Flat Type

SH
Geared
Type

General
Specifications/
Inner Wiring
Diagram of Motor

5-Phase
Motors
PKP

Features
Product
Line

Product
Number
Product Line

Standard
Type

High-
Resolution
Type

TS
Geared
Type

General
Specifications/
Inner Wiring
Diagram of Motor

Driver for
2-Phase/
5-Phase Motors

Accessories

SH Geared Type

Frame Size 42 mm (1.65 in.) (Bipolar 4 Lead Wires)

Specifications

Product Name	Maximum Holding Torque	Rotor Inertia J: kg·m ² (oz·in ²)	Rated Current	Voltage	Winding Resistance	Inductance	Basic Step Angle	Gear Ratio	Permissible Torque	Speed Range	Backlash arcmin	Recommended Driver Product Name*
	N·m (lb·in)		A/Phase	VDC	Ω/Phase	mH/Phase			N·m (lb·in)	r/min		
PKP243D15□2-SG3.6	0.2 (1.77)	36 × 10 ⁻⁷ (0.197)	1.5	0.83	0.55	0.77	0.5°	3.6	0.2 (1.77)	0 - 833	60 (1°)	CVD223FBR-K
PKP243D23□2-SG3.6			2.3	0.87	0.38	0.41						
PKP243D15□2-SG7.2	0.4 (3.5)		1.5	0.83	0.55	0.77	0.25°	7.2	0.4 (3.5)	0 - 416		
PKP243D23□2-SG7.2	2.3		0.87	0.38	0.41							
PKP243D15□2-SG9	0.5 (4.4)		1.5	0.83	0.55	0.77	0.2°	9	0.5 (4.4)	0 - 333		
PKP243D23□2-SG9	2.3		0.87	0.38	0.41							
PKP243D15□2-SG10	0.56 (4.9)		1.5	0.83	0.55	0.77	0.18°	10	0.56 (4.9)	0 - 300		
PKP243D23□2-SG10	2.3		0.87	0.38	0.41							
PKP243D15□2-SG18	0.8 (7)		1.5	0.83	0.55	0.77	0.1°	18	0.8 (7)	0 - 166		
PKP243D23□2-SG18	2.3		0.87	0.38	0.41							
PKP243D15□2-SG36	0.8 (7)		1.5	0.83	0.55	0.77	0.05°	36	0.8 (7)	0 - 83		
PKP243D23□2-SG36	2.3		0.87	0.38	0.41							

● The box □ in the product name indicates the shaft **A** (single shaft) or **B** (double shaft).

*See page 64 for details on the recommended drivers.

Speed – Torque Characteristics (Reference Values) *fs*: Max. Starting Frequency

PKP243D15 Gear Ratio: 3.6

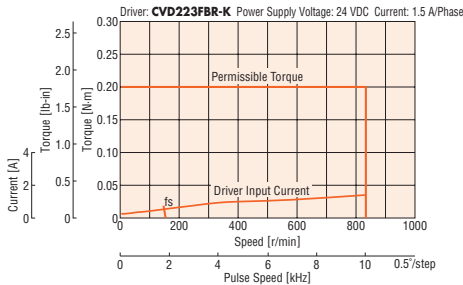

PKP243D15 Gear Ratio: 7.2

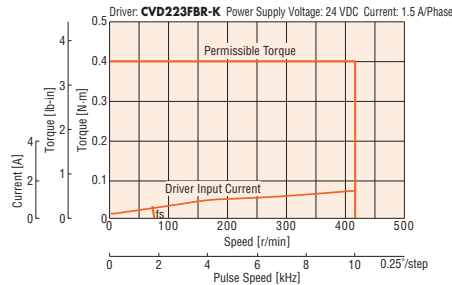

PKP243D15 Gear Ratio: 9

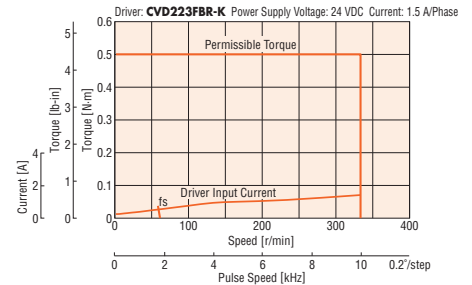

PKP243D15 Gear Ratio: 10

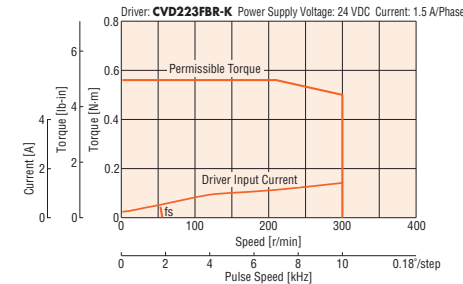

PKP243D15 Gear Ratio: 18

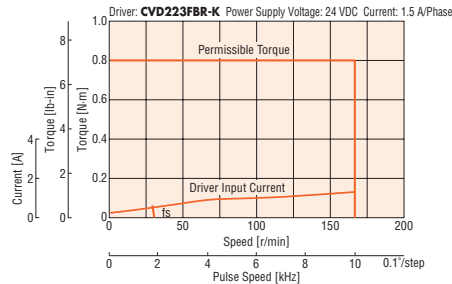

PKP243D15 Gear Ratio: 36

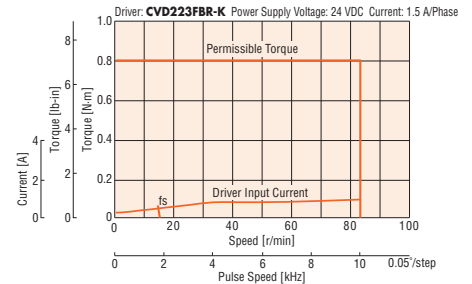

Note

- Data for the speed – torque characteristics is based on Oriental Motor's internal measurement conditions. If the conditions are changed, the characteristics may also change as a result.
- Depending on the driving conditions, a considerable amount of heat may be generated by the motor. Be sure to keep the temperature of the motor case under 100°C (212°F).
- Set the current of the driver so that it does not exceed the rated current of the motor.

Speed – Torque Characteristics (Reference Values) f_s : Max. Starting Frequency

PKP243D23 Gear Ratio: 3.6

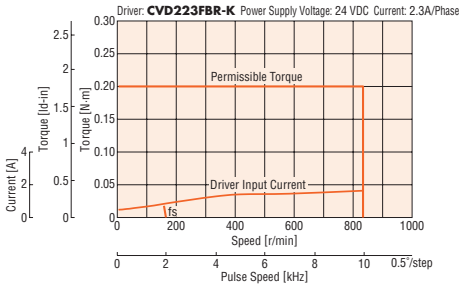

PKP243D23 Gear Ratio: 7.2

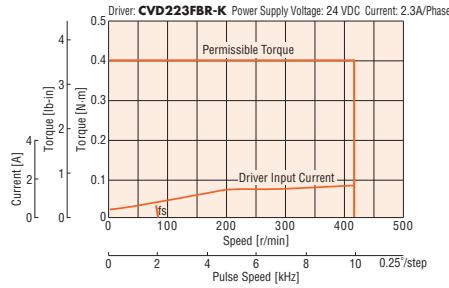

PKP243D23 Gear Ratio: 9

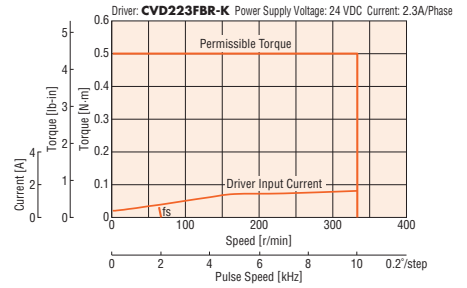

PKP243D23 Gear Ratio: 10

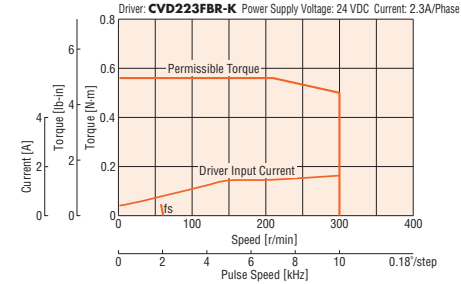

PKP243D23 Gear Ratio: 18

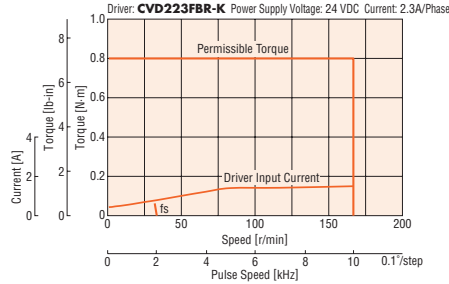

PKP243D23 Gear Ratio: 36

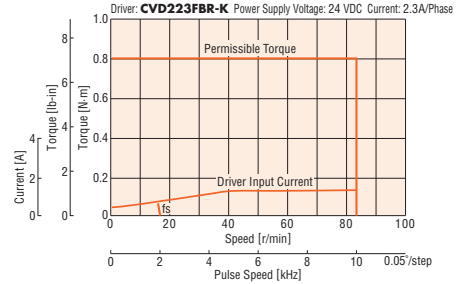

Note

- Data for the speed – torque characteristics is based on Oriental Motor's internal measurement conditions. If the conditions are changed, the characteristics may also change as a result.
- Depending on the driving conditions, a considerable amount of heat may be generated by the motor. Be sure to keep the temperature of the motor case under 100°C (212°F).
- Set the current of the driver so that it does not exceed the rated current of the motor.

Dimensions Unit = mm (in.)

● Motor

2D & 3D CAD

Product Name	Gear Ratio	Mass kg (lb.)	CAD
PKP243D15A2-SG □	3.6, 7.2, 9, 10, 18, 36	0.33 (0.73)	B1340
PKP243D15B2-SG □			
PKP243D23A2-SG □			
PKP243D23B2-SG □			

- A number indicating the gear ratio is specified where the box □ is located in the product name.

● Applicable Connector

Connector Housing: MDF97-5S-3.5C (HIROSE ELECTRIC CO., LTD.)
 Contact: MDF97-22SC (HIROSE ELECTRIC CO., LTD.)
 Crimp Tool: HT801/MDF97-22S (HIROSE ELECTRIC CO., LTD.)

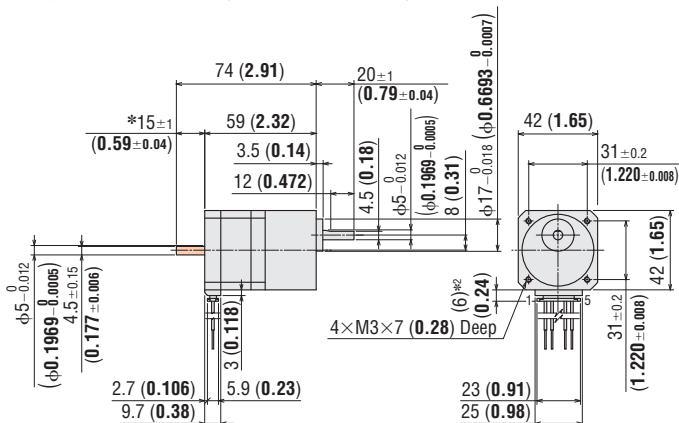

*1 The length of the shaft flat on the double shaft model is 15 ± 0.25 (0.591 ± 0.010).

*2 With connection cable

- These dimensions are for double shaft motors.

For single shaft motors, ignore the shaded areas.

Inner Wiring Diagram of Motor

Wiring Diagram No.: Model A①

- Refer to page 44 for inner wiring diagram of motor.

● Connection Cable (Sold separately)

◇ Connection Cable for Motor

Product Name	Length L m (ft.)
LC2B06E	0.6 (2.2)

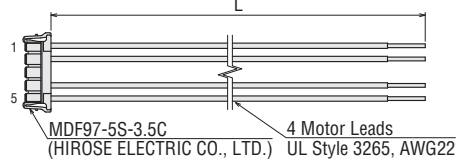

2-Phase
Motors
PKP

Features
Product
Line

Product
Number
Product Line

Standard
Type

High-
Resolution
Type

Flat Type

SH
Geared
Type

General
Specifications/
Inner Wiring
Diagram of Motor

5-Phase
Motors
PKP

Features
Product
Line

Product
Number
Product Line

Standard
Type

High-
Resolution
Type

TS
Geared
Type

General
Specifications/
Inner Wiring
Diagram of Motor

Driver for
2-Phase/
5-Phase Motors

Accessories

SH Geared Type

Frame Size 60 mm (2.36 in.) (Bipolar 4 Lead Wires)

Specifications

Product Name	Maximum Holding Torque N·m (lb·in)	Rotor Inertia J: kg·m ² (oz·in ²)	Rated Current A/Phase	Voltage VDC	Winding Resistance Ω/Phase	Inductance mH/Phase	Basic Step Angle	Gear Ratio	Permissible Torque N·m (lb·in)	Speed Range r/min	Backlash arcmin	Recommended Driver Product Name*
PKP264D14□2-SG3.6	1 (8.8)	140×10 ⁻⁷ (0.77)	1.4	2	1.4	3.1	0.5°	3.6	1 (8.8)	0 - 833	70 (1.17°)	CVD228BR-K
PKP264D28□2-SG3.6			2.8	0.92	0.33	0.81						
PKP264D14□2-SG7.2	2 (17.7)		1.4	2	1.4	3.1	0.25°	7.2	2 (17.7)	0 - 416		
PKP264D28□2-SG7.2			2.8	0.92	0.33	0.81						
PKP264D14□2-SG9	2.5 (22)		1.4	2	1.4	3.1	0.2°	9	2.5 (22)	0 - 333		
PKP264D28□2-SG9			2.8	0.92	0.33	0.81						
PKP264D14□2-SG10	2.7 (23)		1.4	2	1.4	3.1	0.18°	10	2.7 (23)	0 - 300		
PKP264D28□2-SG10			2.8	0.92	0.33	0.81						
PKP264D14□2-SG18	3 (26)		1.4	2	1.4	3.1	0.1°	18	3 (26)	0 - 166		
PKP264D28□2-SG18			2.8	0.92	0.33	0.81						
PKP264D14□2-SG36	4 (35)		1.4	2	1.4	3.1	0.05°	36	4 (35)	0 - 83		
PKP264D28□2-SG36			2.8	0.92	0.33	0.81						

● The box □ in the product name indicates the shaft **A** (single shaft) or **B** (double shaft).

*See page 64 for details on the recommended drivers.

Speed – Torque Characteristics (Reference Values) *f_s*: Max. Starting Frequency

PKP264D14 Gear Ratio: 3.6

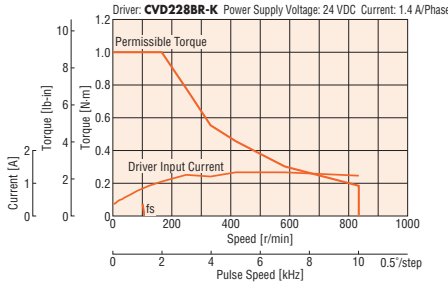

PKP264D14 Gear Ratio: 7.2

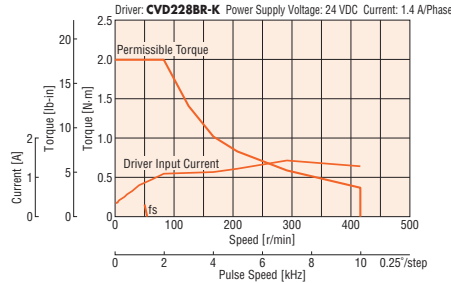

PKP264D14 Gear Ratio: 9

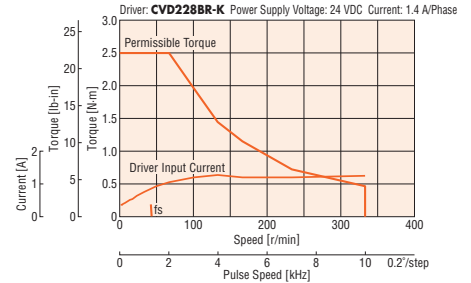

PKP264D14 Gear Ratio: 10

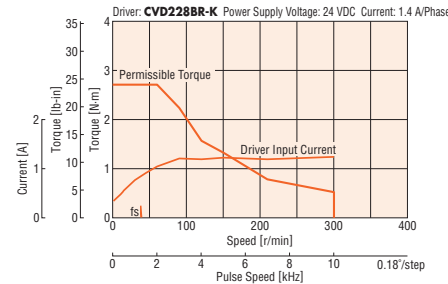

PKP264D14 Gear Ratio: 18

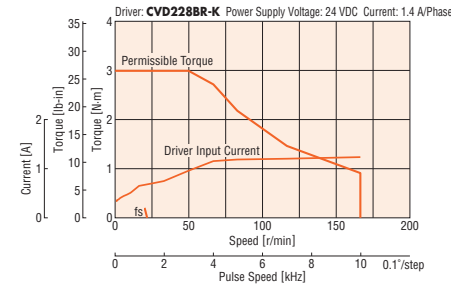

PKP264D14 Gear Ratio: 36

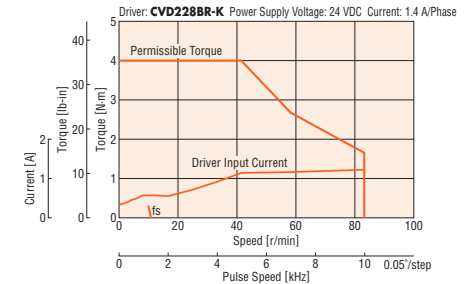

Note

- Data for the speed – torque characteristics is based on Oriental Motor's internal measurement conditions. If the conditions are changed, the characteristics may also change as a result.
- Depending on the driving conditions, a considerable amount of heat may be generated by the motor. Be sure to keep the temperature of the motor case under 100°C (212°F).
- Set the current of the driver so that it does not exceed the rated current of the motor.

Speed – Torque Characteristics (Reference Values) f_s : Max. Starting Frequency

PKP264D28 Gear Ratio: 3.6

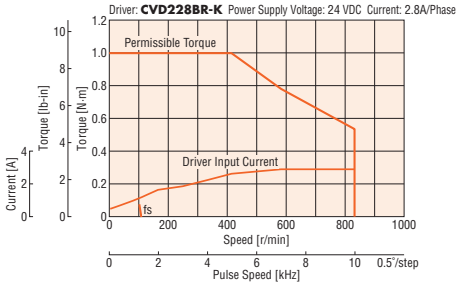

PKP264D28 Gear Ratio: 7.2

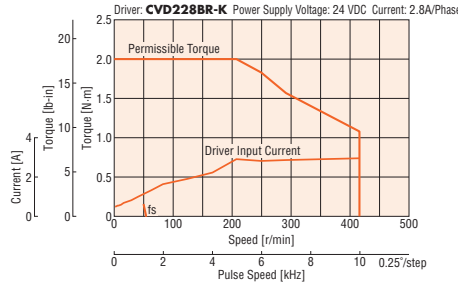

PKP264D28 Gear Ratio: 9

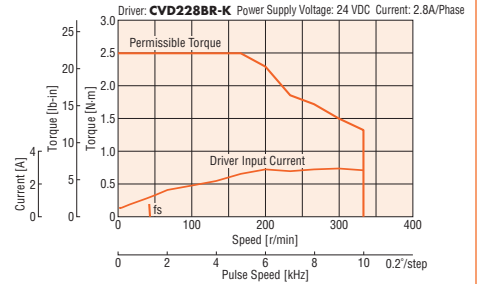

PKP264D28 Gear Ratio: 10

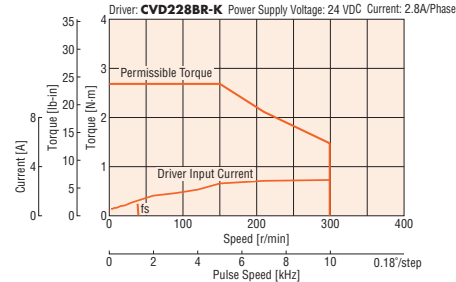

PKP264D28 Gear Ratio: 18

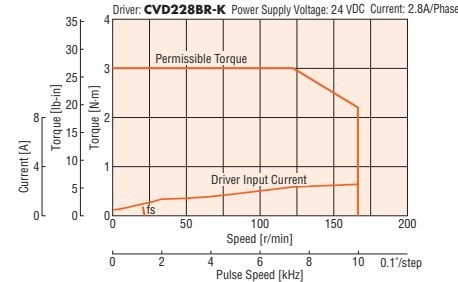

PKP264D28 Gear Ratio: 36

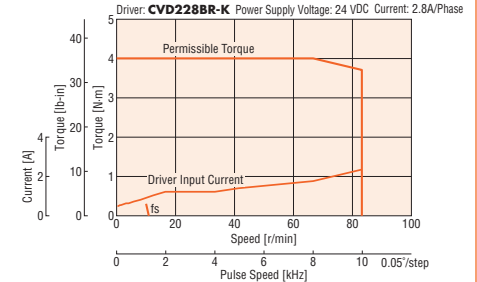

Note

- Data for the speed – torque characteristics is based on Oriental Motor's internal measurement conditions. If the conditions are changed, the characteristics may also change as a result.
- Depending on the driving conditions, a considerable amount of heat may be generated by the motor. Be sure to keep the temperature of the motor case under 100°C (212°F).
- Set the current of the driver so that it does not exceed the rated current of the motor.

Dimensions Unit = mm (in.)

● Motor

2D & 3D CAD

Product Name	Gear Ratio	Mass kg (lb.)	CAD
PKP264D14A2-SG <input type="checkbox"/>	3.6, 7.2, 9, 10, 18, 36	0.76 (1.68)	B1342
PKP264D14B2-SG <input type="checkbox"/>			
PKP264D28A2-SG <input type="checkbox"/>			
PKP264D28B2-SG <input type="checkbox"/>			

● A number indicating the gear ratio is specified where the box is located in the product name.

● Applicable Connector

Connector Housing: MDF97-5S-3.5C (HIROSE ELECTRIC CO., LTD.)
 Contact: MDF97-22SC (HIROSE ELECTRIC CO., LTD.)
 Crimp Tool: HT801/MDF97-22S (HIROSE ELECTRIC CO., LTD.)

● Connection Cable (Sold separately)

◇ Connection Cable for Motor

Product Name	Length L m (ft.)
LC2B06E	0.6 (2.2)

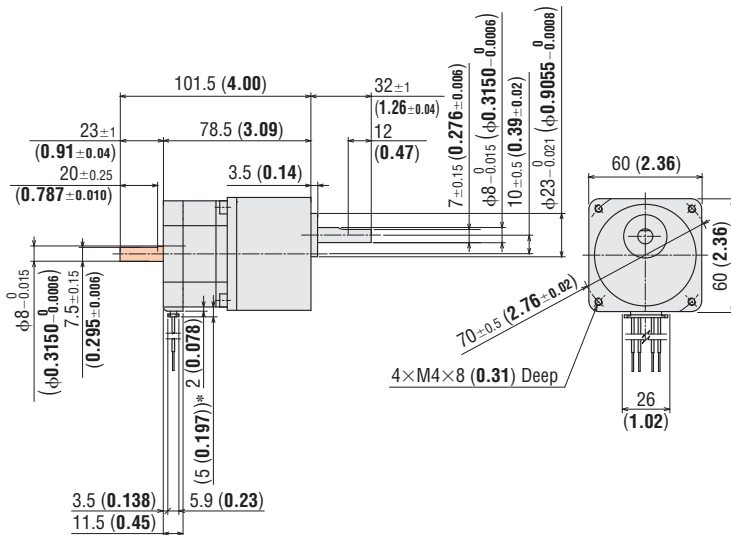
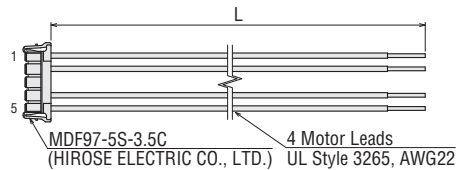

With connection cable

- These dimensions are for double shaft motors.
- For single shaft motors, ignore the shaded areas.

Inner Wiring Diagram of Motor

Wiring Diagram No.: Model A①

- Refer to page 44 for inner wiring diagram of motor.

2-Phase
Motors
PKP

Features
Product
Line

Product
Number
Product Line

Standard
Type

High-
Resolution
Type

Flat Type

SH
Geared
Type

General
Specifications/
Inner Wiring
Diagram of Motor

5-Phase
Motors
PKP

Features
Product
Line

Product
Number
Product Line

Standard
Type

High-
Resolution
Type

TS
Geared
Type

General
Specifications/
Inner Wiring
Diagram of Motor

Driver for
2-Phase/
5-Phase Motors

Accessories

Motor Frame Size

20 mm (0.79 in.)

28 mm (1.10 in.)

35 mm (1.38 in.)

42 mm (1.65 in.)

50 mm (1.97 in.)

56.4 mm (2.22 in.)

60 mm (2.36 in.)

85 mm (3.35 in.)

General Specifications

Specification	Motor	
Thermal Class	130 (B)	
Insulation Resistance	100 MΩ or more when 500 VDC megger is applied between the windings and the case under normal ambient temperature and humidity.	
Dielectric Strength	No abnormalities are observed, even when applying voltage between the windings and the case for 1 minute under normal ambient temperature and humidity with the following conditions. <ul style="list-style-type: none"> • Frame size 42 mm (1.65 in.) and PKP262 max. : 0.5 kVAC 50/60 Hz • Frame size 50 mm (1.97 in.) and 56.4 mm (2.22 in.) min. : 1.0 kVAC 50/60 Hz • Frame size 85 mm (3.35 in.) : 1.5 kVAC 50/60 Hz 	
Operating Environment	Ambient Temperature	-10 to +50°C (+14 to +122°F) (Non-Freezing)
	Ambient Humidity	85% or less (Non-Condensing)
	Surrounding Atmosphere	No corrosive gas or dust. No water or oil.
Temperature Rise	Winding temperature rise 80°C (176°F) max. (Based on Oriental Motor's measurement conditions)	
Stop Position Accuracy*1	±3 arcmin (±0.05°) [PKP21 □ is ±5 arcmin (±0.083°)]	
Shaft Runout	0.05 mm (0.002 in.) T.I.R.*4	
Radial Play*2	0.025 mm (0.001 in.) Max. [load 5 N (1.12 lb.)]	
Axial Play*3	0.075 mm (0.003 in.) Max. [load 10 N (2.2 lb.)] [PKP21 □ is load 1 N (0.225 lb.), PKP22 □, PKP242 and PKP262 are load 2.5 N (0.566 lb.)]	
Concentricity of Installing Pilot to the Shaft	0.075 mm (0.003 in.) T.I.R.*4	
Perpendicularity of Installation Surface to the Shaft	0.075 mm (0.003 in.) T.I.R.*4	

*1 This value is for full step under no load (The value changes with the size of the load).

*2 Radial Play: Displacement in shaft position in the radial direction when a 5 N (1.12 lb.) load is applied in the vertical direction to the tip of the motor shaft.

*3 Axial Play: Displacement in shaft position in the axial direction when a 10 N (2.2 lb.) [**PKP21** □ is 1 N (0.225 lb.), **PKP22** □, **PKP242**, **PKP262** is 2.5 N (0.566 lb.)] load is applied to the motor shaft in the axial direction.

*4 T.I.R. (Total Indicator Reading): The total dial gauge reading when the measurement section is rotated one revolution centered on the reference axis center.

Note

- Do not measure the insulation resistance or perform a dielectric strength test while the motor and driver are connected. Also, do not conduct these tests on the motor encoder section.

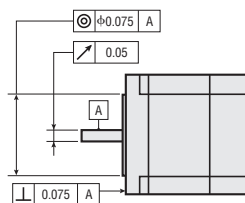

Electromagnetic Brake Specifications

Product Name	PKP22	PKP23 and PKP24	PKP26
Brake Type	Power Off Activated Type		
Power Supply Voltage	24 VDC ±5%		
Power Supply Current	A 0.05	0.07	0.23
Static Friction Torque	N·m (oz·in) 0.08 (11.3)	0.3 (42)	1.5 (213)
Brake Operating Time	ms 20		
Brake Releasing Time	ms 50		
Time Rating	Continuous		

● The product names are listed such that the product names are distinguishable.

Connecting the Electromagnetic Brake

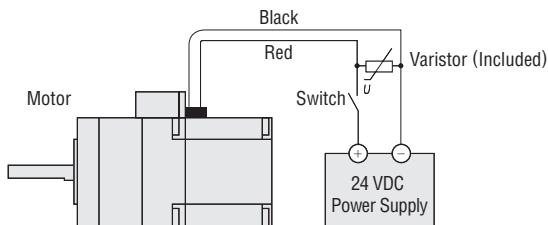

Encoder Specifications

Encoder Product Name	R2EL	R2FL	R2E	R2F
Resolution	200P/R	400P/R	200P/R	400P/R
Output Circuit Type	Line Driver Output*		Voltage Output	
Output Mode	Incremental			
Output Signal	A Phase, B Phase, and Z Phase (3ch)			
Power Supply Voltage	5 VDC ±10%			
Current	30 mA max.		45 mA max.	

*26C31 or equivalent

Permissible Radial Load and Permissible Axial Load

2-Phase Motor

Unit: N (lb.)

Type	Motor Frame Size mm [in.]	Product Name	Gear Ratio	Permissible Radial Load					Permissible Axial Load	
				Distance from Shaft End mm [in.]						
				0 [0]	5 [0.2]	10 [0.39]	15 [0.59]	20 [0.79]		
High-Resolution Type	42 [1.65]	PKP243, PKP244	-	20 (4.5)	25 (5.6)	34 (7.6)	52 (11.7)	-	10(2.2)	
	56.4 [2.22]	PKP264, PKP266, PKP268		61 (13.7)	73 (16.4)	90 (20)	110 (24)	160 (36)	20(4.5)	
Standard Type	20 [0.79]	PKP213, PKP214		12 (2.7)	15 (3.3)	-	-	-	3(0.67)	
	28 [1.10]	PKP223, PKP225, PKP523, PKP525		25 (5.6)	34 (7.6)	52 (11.7)	-	-	5(1.12)	
	35 [1.38]	PKP233, PKP235		20 (4.5)	25 (5.6)	34 (7.6)	52 (11.7)	-	10(2.2)	
	42 [1.65]	PKP243□2, PKP244□2, PKP245□2, PKP246□2		35 (7.8)	44 (9.9)	58 (13)	85 (19.1)	-	15(3.3)	
	50 [1.97]	PK256, PK258		35 (7.8)	44 (9.9)	58 (13)	85 (19.1)	-	15(3.3)	
	56.4 [2.22]	PKP264□2, PKP266□2, PKP268□2		54 (12.1)	67 (15)	89 (20)	130 (29.2)	-	20(4.5)	
Flat Standard	42 [1.65]	PKP242		20 (4.5)	25 (5.6)	34 (7.6)	-	-	5 (1.12)	
	60 [2.36]	PKP262		20 (4.5)	25 (5.6)	34 (7.6)	-	-	5 (1.12)	
Standard Type	85 [3.35]	PKP296, PKP299, PKP2913		-	260 (58)	290 (65)	340 (76)	390 (87)	480 (108)	60(13.5)
SH Geared Type	28 [1.10]	PKP223		7.2, 9, 10, 18, 36	15 (3.3)	17 (3.8)	20 (4.5)	23 (5.1)	-	10(2.2)
	42 [1.65]	PKP243	3.6, 7.2, 9, 10, 18, 36	10 (2.2)	15 (3.3)	20 (4.5)	30 (6.7)	-	15(3.3)	
	60 [2.36]	PKP264	3.6, 7.2, 9, 10	30 (6.7)	40 (9)	50 (11.2)	60 (13.5)	70 (15.7)	30(6.7)	
			18, 36	80 (18)	100 (22)	120 (27)	140 (31)	160 (36)		

Radial Load and Axial Load

Distance from Shaft End [mm (in.)]

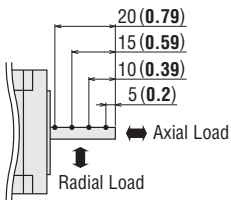

2-Phase Motors
PKP

Features
Product Line

Product Number
Product Line

Standard Type

High-Resolution Type

Flat Type

SH Geared Type

General Specifications/
Inner Wiring Diagram of Motor

5-Phase Motors
PKP

Features
Product Line

Product Number
Product Line

Standard Type

High-Resolution Type

TS Geared Type

General Specifications/
Inner Wiring Diagram of Motor

Driver for
2-Phase/
5-Phase Motors

Accessories

Inner Wiring Diagram for Motor

Motor Frame Size

20 mm (0.79 in.)

28 mm (1.10 in.)

35 mm (1.38 in.)

42 mm (1.65 in.)

50 mm (1.97 in.)

56.4 mm (2.22 in.)

60 mm (2.36 in.)

85 mm (3.35 in.)

Motor Model Type	Wiring Diagram/Pinout		
Model A	<p>① Bipolar 4 Lead Wires</p>	<p>② Unipolar 5 Lead Wires</p>	-Pinout Pin No. → 5 1
	<p>● The colors in the wiring diagram are the colors of the separately sold connection cables.</p>		
Model B	<p>③ Bipolar 4 Lead Wires</p>	<p>④ Unipolar 6 Lead Wires</p>	-Pinout Pin No. → 1 6
	<p>● The colors in the wiring diagram are the colors of the separately sold connection cables.</p>		
Model C	<p>⑤ Bipolar 4 Lead Wires</p>	<p>⑥ Unipolar 5 Lead Wires</p>	<p>⑦ Unipolar 6 Lead Wires</p> <p>Motor lead wire colors: Blue, white, red, black, yellow, green</p>
	<p>● The colors in the wiring diagram are the colors of the separately sold connection cables.</p>		

5-Phase Stepper Motors PKP Series

● For detailed information about regulations and standards, please see the Oriental Motor website.

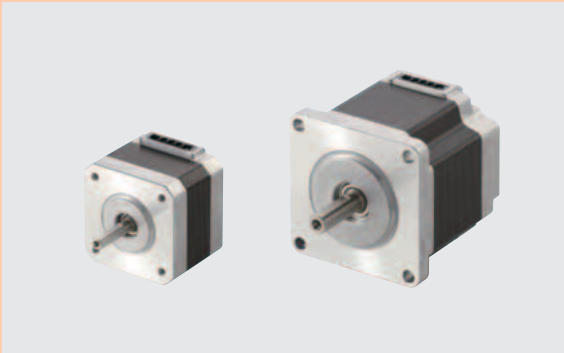

This is a high torque and low vibration stepper motor with a basic step angle of 0.72° (resolution of 500 steps per revolution).

High positioning accuracy is possible through low vibration and reduced noise.

(A separate dedicated driver is required to operate each motor.)



See Full Product Details Online
www.orientalmotor.com

● Manual

● Specifications

● Dimensions

● CAD

● Characteristics

● Connection and Operation

2-Phase Motors
PKP

Features
Product Line

Product Number
Product Line

Standard Type

High-Resolution Type

Flat Type

SH Geared Type

General Specifications/
Inner Wiring Diagram of Motor

5-Phase Motors
PKP

Features
Product Line

Product Number
Product Line

Standard Type

High-Resolution Type

TS Geared Type

General Specifications/
Inner Wiring Diagram of Motor

Driver for 2-Phase/
5-Phase Motors

Accessories

Features

High Accuracy

Since the step angle of the **PKP Series** 5-Phase Stepper Motor is at 0.72° (high-resolution type at 0.36°) and the stopping accuracy is at $\pm 0.05^\circ$, highly accurate positioning is possible. In addition, the stop position accuracy controlled by a microstep driver has almost the same high accuracy as that controlled by a full-step driver.

● General 2-Phase Stepper Motor

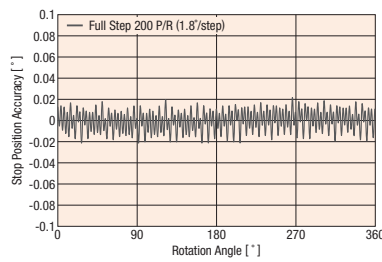

Microstepping reduces stopping accuracy.

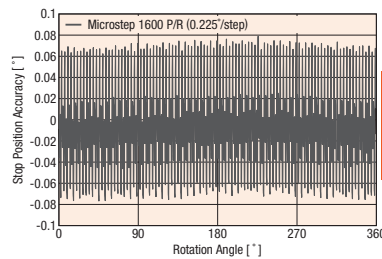

PKP Series Highly accurate positioning for 5-Phase Stepper Motor is possible.

● 5-Phase Stepper Motor PKP Series

(Driver: **CVD** driver for 5-Phase Stepper Motor)

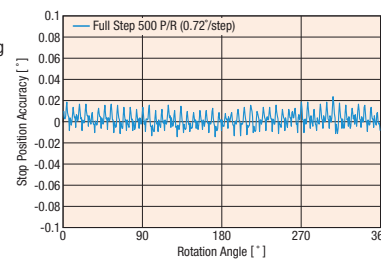

5-Phase Microstepping does not reduce stopping accuracy.

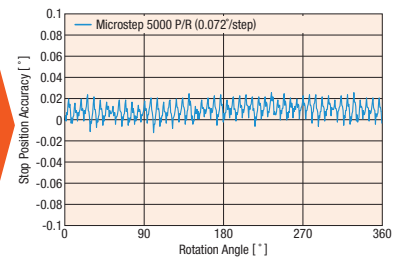

Low Vibration and Reduced Noise

Because the basic step angle is small at 0.72° (0.36° for high-resolution type), the vibrations and noise are lower than the 2-Phase stepper motor. Also, vibrations and noise can be further reduced by an advanced microstep driver.

● Example of 2-Phase Stepper Motor Vibration Characteristics

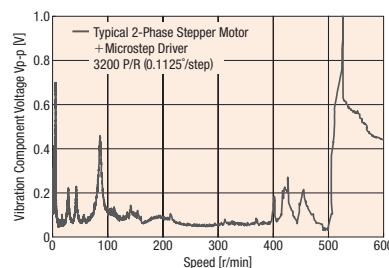

PKP Series Vibration characteristics for 5-Phase Stepper Motor have been further improved.

● Example of 5-Phase Stepper Motor Vibration Characteristics

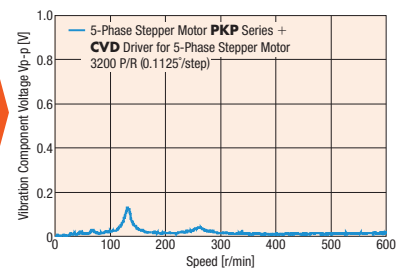

Motor
Frame Size

20 mm
(0.79 in.)

28 mm
(1.10 in.)

35 mm
(1.38 in.)

42 mm
(1.65 in.)

50 mm
(1.97 in.)

56.4 mm
(2.22 in.)

60 mm
(2.36 in.)

85 mm
(3.35 in.)

Product Line Utilizing a Compact and Flat Connector

We offer a product line utilizing compact and flat connectors. The motor cable outlet direction points upward, which increases the degrees of freedom for the cable outlet direction.

● The connector configuration differs by motor. For more details, check the motor dimensions.

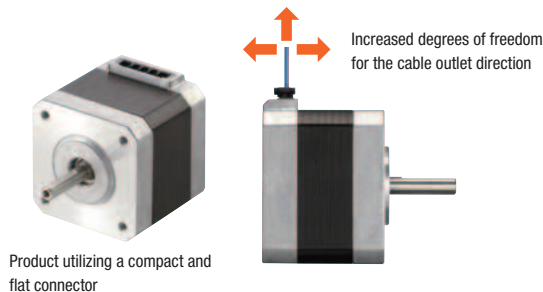

Product Line

—: Not Offered in This Product Line

Type (Basic step angle)	Features	Frame Size			
		28 mm (1.10 in.)	42 mm (1.65 in.)	56.4 mm (2.22 in.)	60 mm (2.36 in.)
Standard Type (0.72°)	<ul style="list-style-type: none"> Standard model High torque, low vibration 				
High-Resolution Type (0.36°)	<ul style="list-style-type: none"> Double the resolution of the standard type motor High positioning accuracy and reduced vibration 	—		—	
Standard Type with Encoder (0.72°)	<ul style="list-style-type: none"> Encoder resolution 500 P/R, A, B, and Z (3 ch) output signals Utilizes a compact encoder Encoder with superior noise resistance and a line driver (differential) output 	—			
TS Geared Type (0.024~0.2°)	<ul style="list-style-type: none"> Spur Gear Mechanism A wide variety of low gear ratios, high-speed operations Gear ratio types: 3.6, 7.2, 10, 20, 30 	—		—	

System Configuration

These accessories allow 5-Phase stepper motors in the **PKP** Series to be used for various operations. Motors and connection cables must be ordered individually.

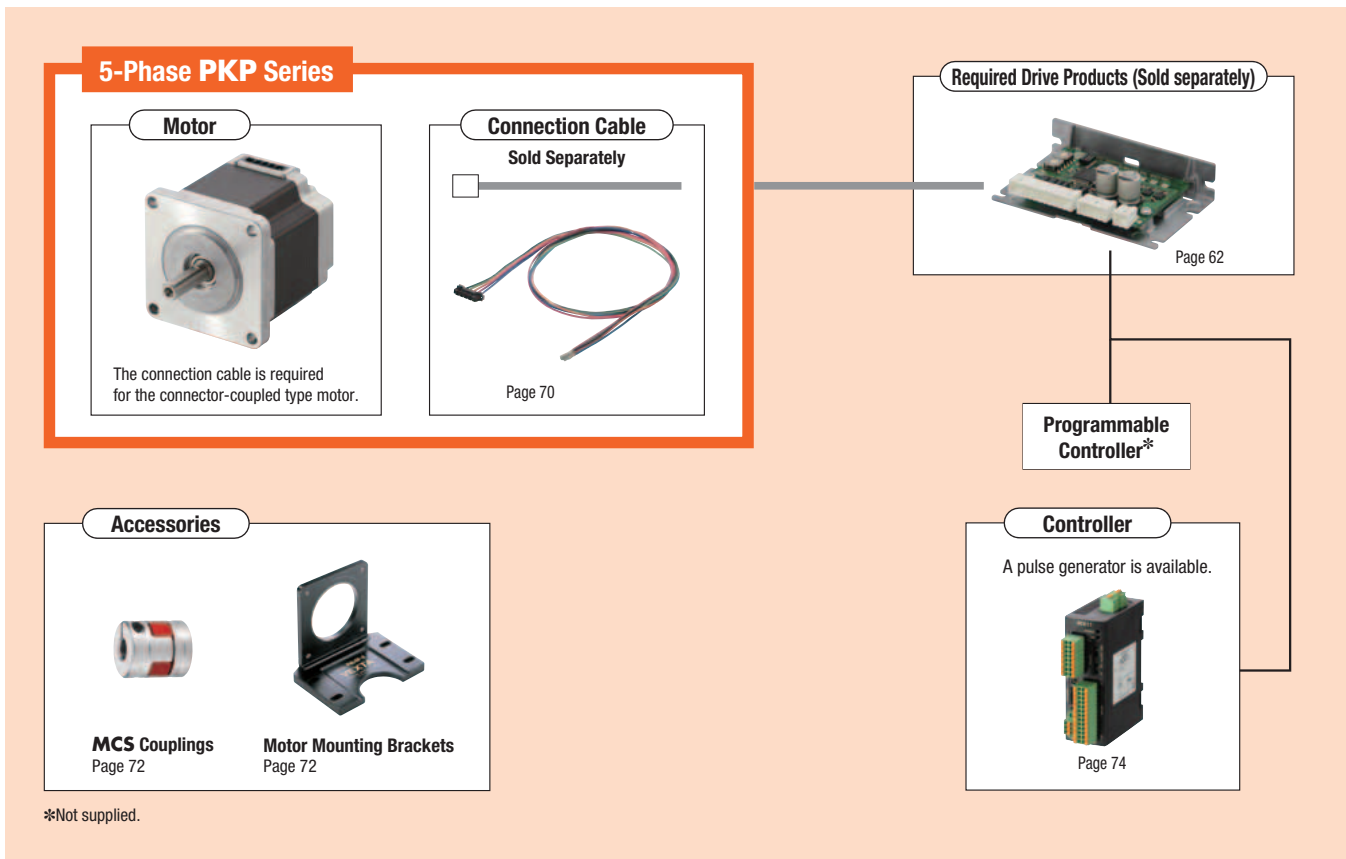

● The system configuration shown above is an example. Other combinations are also available.

Product Number

● Motor

◇ Standard Type, High-Resolution Type

PKP 5 6 6 F N 24 A 2

① ② ③ ④ ⑤ ⑦ ⑧ ⑨ ⑩

PKP 5 4 4 M N 18 A

① ② ③ ④ ⑥ ⑦ ⑧ ⑨

◇ Standard Type with Encoder

PKP 5 6 6 F N 24 A 2 - R2G L

① ② ③ ④ ⑤ ⑦ ⑧ ⑨ ⑩ ⑪ ⑫

◇ TS Geared Type

PKP 5 4 3 N 18 A 2 - TS 30

① ② ③ ④ ⑤ ⑥ ⑦ ⑧ ⑨ ⑩

①	Series Name	PKP: PKP Series
②	5 : 5-Phase	
③	Motor Frame Size	2 : 28 mm (1.10 in.) 4 : 42 mm (1.65 in.) 6 : 56.4 mm (2.22 in.) [60 mm (2.36 in.) when the motor classification is "F"]
④	Motor Case Length	
⑤	Motor Classification	Blank: Motor Frame Size of 56.4 mm (2.22 in.) F : Motor Frame Size of 60 mm (2.36 in.)
⑥	Motor Type	Blank: Standard Type M : High-Resolution Type
⑦	Number of Lead Wires	N : 5 Leads
⑧	Motor Winding Specifications	
⑨	Configuration	A : Single Shaft B : Double Shaft
⑩	Reference Number	
⑪	Encoder Resolution	R2G : 500 P/R
⑫	Encoder Output Circuit Type	Blank: Voltage Output L : Line Driver Output

①	Series Name	PKP: PKP Series
②	5 : 5-Phase	
③	Motor Frame Size	4 : 42 mm (1.65 in.) 6 : 60 mm (2.36 in.)
④	Motor Case Length	
⑤	Number of Lead Wires	N : 5 Leads
⑥	Motor Winding Specifications	
⑦	Configuration	A : Single Shaft B : Double Shaft
⑧	Reference Number	
⑨	Geared Type	TS : TS Geared Type
⑩	Gear Ratio	

2-Phase
Motors
PKP

Features
Product
Line

Product
Number
Product Line

Standard
Type

High-
Resolution
Type

Flat Type

SH
Geared
Type

General
Specifications/
Inner Wiring
Diagram of Motor

5-Phase
Motors
PKP

Features
Product
Line

Product
Number
Product Line

Standard
Type

High-
Resolution
Type

TS
Geared
Type

General
Specifications/
Inner Wiring
Diagram of Motor

Driver for
2-Phase/
5-Phase Motors

Accessories

Motor Frame Size

20 mm (0.79 in.)

28 mm (1.10 in.)

35 mm (1.38 in.)

42 mm (1.65 in.)

50 mm (1.97 in.)

56.4 mm (2.22 in.)

60 mm (2.36 in.)

85 mm (3.35 in.)

● Connection Cable

◇ Connection Cable for Motor

LC 5 N 06 E

- ① ② ③ ④ ⑤

◇ Connection Cable for Encoder

LC E 08 A - 006

- ① ② ③ ④ ⑤

■ Product Line

● Motor

◇ Standard Type

Product Name (Single Shaft)	List Price	Product Name (Double Shaft)	List Price
PKP523N12A	\$64.00	PKP523N12B	\$66.00
PKP525N12A	\$74.00	PKP525N12B	\$76.00
PKP543N18A2	\$52.00	PKP543N18B2	\$54.00
PKP544N18A2	\$54.00	PKP544N18B2	\$56.00
PKP545N18A2	\$61.00	PKP545N18B2	\$64.00
PKP546N18A2	\$63.00	PKP546N18B2	\$66.00
PKP564N28AA2	\$63.00	PKP564N28BA2	\$66.00
PKP566N28AA2	\$69.00	PKP566N28BA2	\$72.00
PKP568N28AA2	\$86.00	PKP568N28BA2	\$90.00
PKP564FN24A2	\$69.00	PKP564FN24B2	\$72.00
PKP564FN38A2	\$69.00	PKP564FN38B2	\$72.00
PKP566FN24A2	\$75.00	PKP566FN24B2	\$78.00
PKP566FN38A2	\$75.00	PKP566FN38B2	\$78.00
PKP569FN24A2	\$92.00	PKP569FN24B2	\$95.00
PKP569FN38A2	\$92.00	PKP569FN38B2	\$95.00

◇ High-Resolution Type

Product Name (Single Shaft)	List Price	Product Name (Double Shaft)	List Price
PKP544MN18A	\$54.00	PKP544MN18B	\$56.00
PKP546MN18A	\$62.00	PKP546MN18B	\$64.00
PKP564FMN24A	\$61.00	PKP564FMN24B	\$63.00
PKP566FMN24A	\$67.00	PKP566FMN24B	\$69.00
PKP569FMN24A	\$90.00	PKP569FMN24B	\$93.00

◇ TS Geared Type

Product Name (Single Shaft)	List Price	Product Name (Double Shaft)	List Price
PKP544N18A2-TS3.6	\$198.00	PKP544N18B2-TS3.6	\$200.00
PKP544N18A2-TS7.2	\$198.00	PKP544N18B2-TS7.2	\$200.00
PKP544N18A2-TS10	\$214.00	PKP544N18B2-TS10	\$216.00
PKP543N18A2-TS20	\$214.00	PKP543N18B2-TS20	\$216.00
PKP543N18A2-TS30	\$214.00	PKP543N18B2-TS30	\$216.00
PKP566N28A2-TS3.6	\$229.00	PKP566N28B2-TS3.6	\$232.00
PKP566N28A2-TS7.2	\$229.00	PKP566N28B2-TS7.2	\$232.00
PKP566N28A2-TS10	\$245.00	PKP566N28B2-TS10	\$248.00
PKP564N28A2-TS20	\$245.00	PKP564N28B2-TS20	\$248.00
PKP564N28A2-TS30	\$245.00	PKP564N28B2-TS30	\$248.00

■ Included Items

Type	Accessories	Parallel Key	Motor Installation Screw	Operating Manual
Standard Type				1 Set
High-Resolution Type				
TS Geared Type	Frame Size 42 mm (1.65 in.)			1 Piece
	Frame Size 60 mm (2.36 in.)	1 Piece	M4×60 P0.7 (4 screws)	

①	Cables	LC: Connector-Type Leads
②	5: 5-Phase	
③	Cable Type	N: For 5-Phase Stepper Motor
④	Cable Length	06: 0.6 m (2 ft.) 10: 1 m (3.3 ft.)
⑤	Reference Number	

①	Cables	LC: Connector-Type Leads
②	Cable Type	E: For Encoder
③	Applicable Models	05: For Voltage Output 08: For Line Driver Output
④	Reference Number	
⑤	Cable Length	006: 0.6 m (2 ft.)

◇ Standard Type with Encoder

Product Name (Voltage Output)	List Price	Product Name (Line Driver Output)	List Price
PKP543N18A2-R2G	\$109.00	PKP543N18A2-R2GL	\$109.00
PKP544N18A2-R2G	\$112.00	PKP544N18A2-R2GL	\$112.00
PKP545N18A2-R2G	\$118.00	PKP545N18A2-R2GL	\$118.00
PKP546N18A2-R2G	\$121.00	PKP546N18A2-R2GL	\$121.00
PKP564N28A2-R2G	\$121.00	PKP564N28A2-R2GL	\$121.00
PKP566N28A2-R2G	\$127.00	PKP566N28A2-R2GL	\$127.00
PKP568N28A2-R2G	\$144.00	PKP568N28A2-R2GL	\$144.00
PKP564FN24A2-R2G	\$127.00	PKP564FN24A2-R2GL	\$127.00
PKP564FN38A2-R2G	\$127.00	PKP564FN38A2-R2GL	\$127.00
PKP566FN24A2-R2G	\$132.00	PKP566FN24A2-R2GL	\$132.00
PKP566FN38A2-R2G	\$132.00	PKP566FN38A2-R2GL	\$132.00
PKP569FN24A2-R2G	\$150.00	PKP569FN24A2-R2GL	\$150.00
PKP569FN38A2-R2G	\$150.00	PKP569FN38A2-R2GL	\$150.00

● Connection Cable for Motor

Product Name	Length	List Price
LC5N06A	0.6 m (2 ft.)	\$5.00
LC5N10A	1 m (3.3 ft.)	\$7.00
LC5N06B	0.6 m (2 ft.)	\$7.00
LC5N10B	1 m (3.3 ft.)	\$10.00
LC5N06C	0.6 m (2 ft.)	\$10.00
LC5N10C	1 m (3.3 ft.)	\$13.00
LC5N06E	0.6 m (2 ft.)	\$6.00

● Connection Cable for Encoder

Product Name	Length	List Price
LCE05A-006	0.6 m (2 ft.)	\$11.00
LCE08A-006	0.6 m (2 ft.)	\$11.00

■ Included

Type	Operating Manual
Common to All Types	1 Copy

Standard Type

Frame Size 28 mm (1.10 in.)

2-Phase
Motors
PKP

Specifications

Product Name	Max. Holding Torque	Rotor Inertia	Rated Current	Winding Resistance	Basic Step Angle	Recommended Driver Product Name*
Single Shaft	N·m (oz·in)	J·kg·m ² (oz·in ²)	A/Phase	Ω/Phase		
PKP523N12 □	0.052 (7.3)	9×10 ⁻⁷ (0.049)	1.2	0.63	0.72°	CVD512BR-K
PKP525N12 □	0.091 (12.9)	18×10 ⁻⁷ (0.098)		1		

*Refer to page 64 for details on the recommended driver.

● The box □ in the product name indicates the shaft **A** (single shaft) or **B** (double shaft).

Features
Product
Line

Product
Number
Product Line

Standard
Type

High-
Resolution
Type

Flat Type

SH
Geared
Type

General
Specifications/
Inner Wiring
Diagram of Motor

Speed – Torque Characteristics (Reference values) *fs*: Max. Starting Frequency

PKP523N12

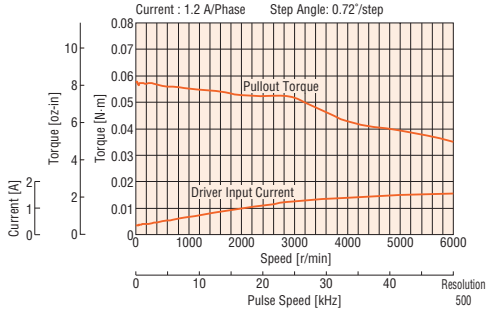

PKP525N12

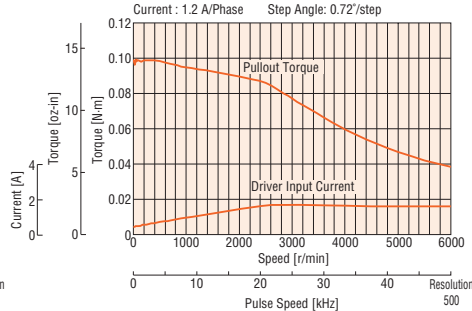

● The pulse input circuit responds up to 1 MHz with a pulse duty of 50%.

Note

● Depending on the driving conditions, a considerable amount of heat may be generated by the motor. Be sure to keep the motor case temperature under 100°C (212°F).

5-Phase
Motors
PKP

Features
Product
Line

Product
Number
Product Line

Standard
Type

High-
Resolution
Type

TS
Geared
Type

General
Specifications/
Inner Wiring
Diagram of Motor

Dimensions Unit = mm (in.)

Motor Product Name	L1	L2	Mass kg (lb.)	CAD
PKP523N12A	32 (1.26)	—	0.11 (0.24)	B1146
PKP523N12B		42 (1.65)		
PKP525N12A	51.5 (2.03)	—	0.2 (0.44)	B1147
PKP525N12B		61.5 (2.42)		

● A 0.6 m (2 ft.) motor connection cable is included with each package : **LC5N06A**

● Applicable Connector

Connector housing: 51065-0500 (Molex)

Contact: 50212-8100 (Molex)

Crimp tool: 57176-5000 (Molex)

● Connection Cable (Sold separately)

◇ Connection Cable for Motor

Product Name	Length L m (ft.)
LC5N06A	0.6 (2)
LC5N10A	1 (3.3)

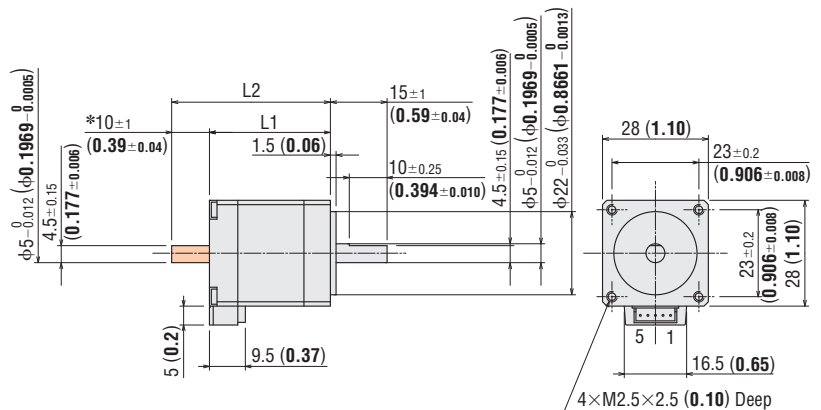
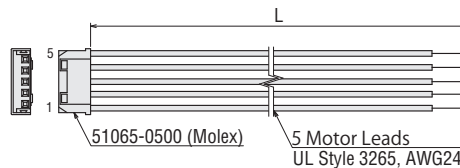

*The length of machining on the double shaft product is 10±0.25 (0.394±0.010).

Motor Pinout

Motor Pinout: Model B

● Refer to page 60 for motor pinout.

Driver for
2-Phase/
5-Phase Motors

Accessories

Standard Type

Frame Size 42 mm (1.65 in.)

Specifications

Product Name	Maximum Holding Torque N·m (oz·in)	Rotor Inertia J: kg·m ² (oz·in ²)	Rated Current A/Phase	Winding Resistance Ω/Phase	Basic Step Angle	Recommended Driver Product Name*
PKP543N18 □2	0.22 (31)	35×10^{-7} (0.192)	1.8	0.4	0.72°	CVD518BR-K
PKP544N18 □2	0.3 (42)	55×10^{-7} (0.3)		0.48		
PKP545N18 □2	0.37 (52)	71×10^{-7} (0.39)		0.55		
PKP546N18 □2	0.5 (71)	110×10^{-7} (0.6)		0.64		

● The box □ in the product name indicates the shaft **A** (single shaft) or **B** (double shaft).

*See page 64 for details on the recommended drivers.

Speed – Torque Characteristics (Reference Values) fs: Max. Starting Frequency

PKP543N18

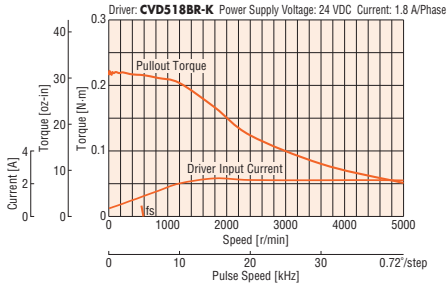

PKP544N18

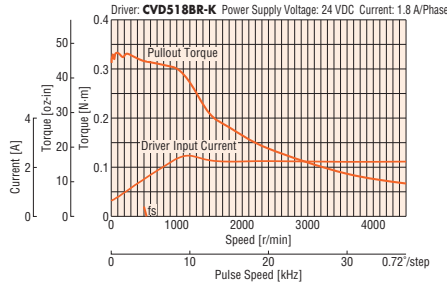

PKP545N18

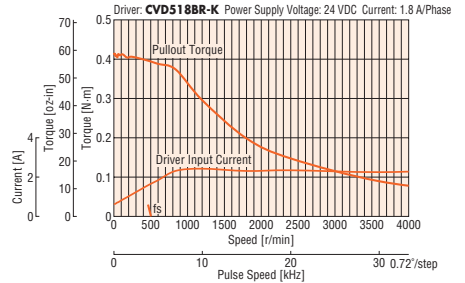

PKP546N18

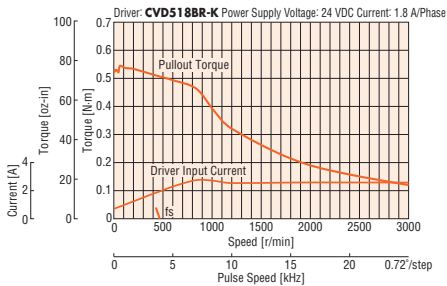

Note

- Data for the speed - torque characteristics is based on Oriental Motor's internal measurement conditions. If the conditions are changed, the characteristics may also change as a result.
- Depending on the driving conditions, a considerable amount of heat may be generated by the pullout the motor. Be sure to keep the motor case temperature at 100°C (212°F) max.
- Set the current of the driver so that it does not exceed the rated current of the motor.

Dimensions Unit = mm (in.)

Motor

2D & 3D CAD

Product Name	L1	L2	Mass kg (lb.)	2D CAD
PKP543N18A2	33	—	0.23	B1264
PKP543N18B2	(1.30)	48 (1.89)	(0.51)	
PKP544N18A2	39	—	0.29	B1265
PKP544N18B2	(1.54)	54 (2.13)	(0.64)	
PKP545N18A2	47	—	0.37	B1266
PKP545N18B2	(1.85)	62 (2.44)	(0.81)	
PKP546N18A2	59	—	0.49	B1267
PKP546N18B2	(2.32)	74 (2.91)	(1.08)	

- Applicable Connectors
- Connector Housing: MDF97-5S-3.5C (HIROSE ELECTRIC CO.,LTD)
- Contact: MDF97-22SC (HIROSE ELECTRIC CO.,LTD)
- Crimping Tool: HT801/MDF97-22S (HIROSE ELECTRIC CO.,LTD)

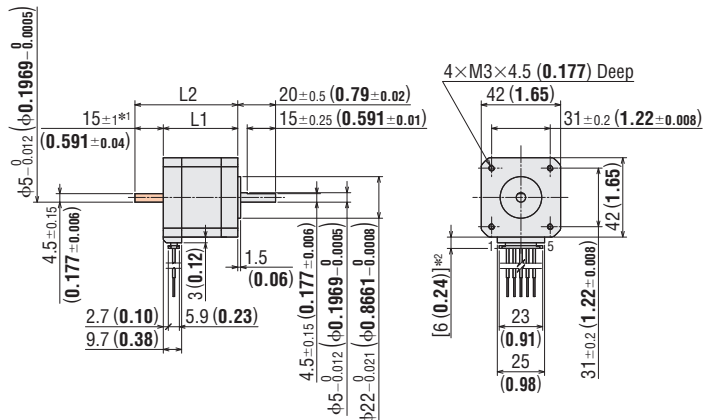

- *1 The length of the shaft flat on the double shaft model is 15±0.25 (0.591±0.0010)
- *2 With connection cable.
- These dimensions are for double shaft motors.
- For single shaft motors, ignore the shaft the (□) areas.

Connection Cable (Sold separately)

Motor Connection Cables

Product Name	Length L m (in.)
LC5N06E	0.6 (24)

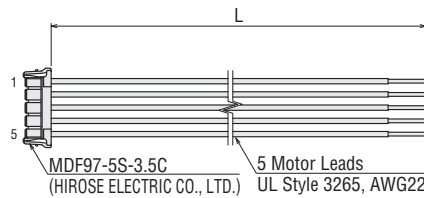

Motor Pinout

Motor Pinout: Model A

- Refer to page 60 for motor pinout.

Standard Type with Encoder

Frame Size 42 mm (1.65 in.)

Specifications

Product Name	Maximum Holding Torque N·m (oz·in)	Rotor Inertia J: kg·m ² (oz·in ²)	Rated Current A/Phase	Winding Resistance Ω/Phase	Basic Step Angle	Recommended Driver Product Name*
PKP543N18A2-R2G	0.22 (31)	35×10 ⁻⁷ (0.192)	1.8	0.4	0.72°	CVD518BR-K
PKP544N18A2-R2G	0.3 (42)	55×10 ⁻⁷ (0.3)		0.48		
PKP545N18A2-R2G	0.37 (52)	71×10 ⁻⁷ (0.39)		0.55		
PKP546N18A2-R2G	0.5 (71)	110×10 ⁻⁷ (0.6)		0.64		

● The box in the product name indicates the encoder output circuit type L (line driver output). The voltage output type will have no "L" in the product name.

*See page 60 for encoder specification.

*See page 64 for details on the recommended drivers.

Speed – Torque Characteristics (Reference Values) *f_s*: Max. Starting Frequency

PKP543N18

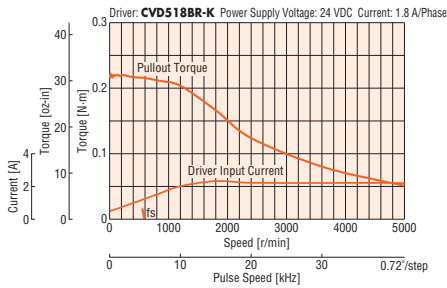

PKP544N18

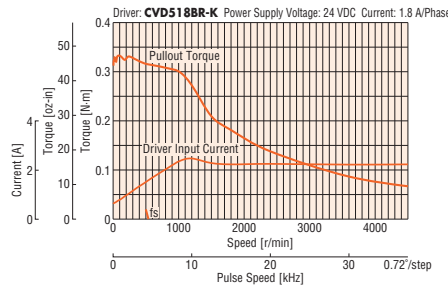

PKP545N18

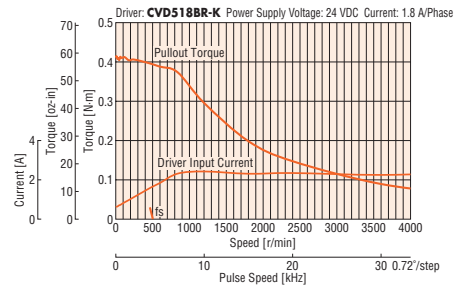

PKP546N18

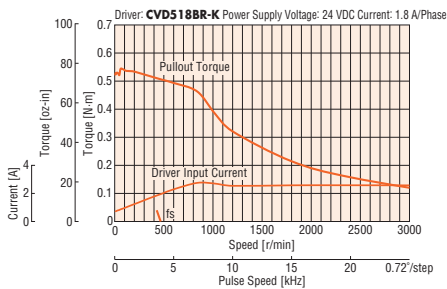

Note

- Data for the speed - torque characteristics is based on Oriental Motor's internal measurement conditions. If the conditions are changed, the characteristics may also change as a result.
- For the type with an encoder, to protect the encoder, be sure to keep the motor case temperature at 85°C (185°F) max.
- Set the current of the driver so that it does not exceed the rated current of the motor.

Dimensions Unit = mm (in.)

● Motor

2D & 3D CAD

Product Name	L	Mass kg (lb.)	2D CAD
PKP543N18A2-R2G	46.5 (1.83)	0.24 (0.53)	B1343
PKP544N18A2-R2G	52.5 (2.07)	0.3 (0.66)	B1344
PKP545N18A2-R2G	60.5 (2.38)	0.38 (0.84)	B1345
PKP546N18A2-R2G	72.5 (2.85)	0.5 (1.1)	B1346

● Applicable Connectors

	Motor (HIROSE ELECTRIC CO.,LTD.)	Encoder (Molex)
Connector Housing	MDF97-5S-3.5C	51021-0800
Contact	MDF97-22SC	50079-8100
Crimping Tool	HT801/MDF97-22S	57067-3000

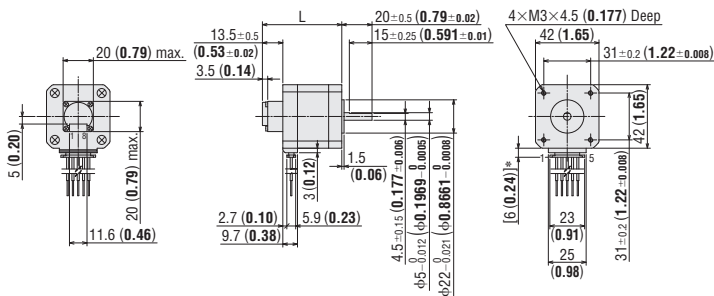

*With connection cable.

Motor Pinout

Motor Pinout: Model A

● Refer to page 60 for motor pinout.

● Connection Cables (Sold separately)

◇ Motor Connection Cable

Product Name	Length L m (in.)
LC5N06E	0.6 (24)

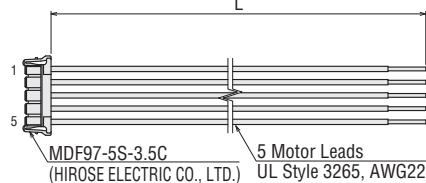

◇ Encoder Connection Cable

Product Name	Applicable Encoder	Length L m (ft.)
LCE05A-006	Voltage Output	0.6 (2)
LCE08A-006	Line Driver Output	0.6 (2)

◇ Voltage Output

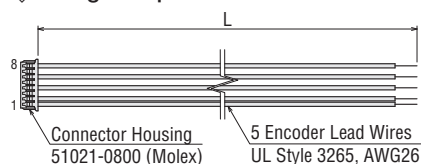

◇ Line Driver Output

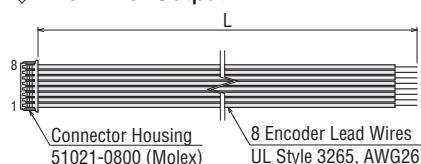

2-Phase
Motors
PKP

Features
Product
Line

Product
Number
Product Line

Standard
Type

High-
Resolution
Type

Flat Type

SH
Geared
Type

General
Specifications/
Inner Wiring
Diagram of Motor

5-Phase
Motors
PKP

Features
Product
Line

Product
Number
Product Line

Standard
Type

High-
Resolution
Type

TS
Geared
Type

General
Specifications/
Inner Wiring
Diagram of Motor

Driver for
2-Phase/
5-Phase Motors

Accessories

Standard Type

Frame Size 56.4 mm (2.22 in.)

20 mm
(0.79 in.)

28 mm
(1.10 in.)

35 mm
(1.38 in.)

42 mm
(1.65 in.)

50 mm
(1.97 in.)

56.4 mm
(2.22 in.)

60 mm
(2.36 in.)

85 mm
(3.35 in.)

Specifications

Product Name	Maximum Holding Torque N·m (oz·in)	Rotor Inertia J: kg·m ² (oz·in ²)	Rated Current A/Phase	Winding Resistance Ω/Phase	Basic Step Angle	Recommended Driver Product Name*
PKP564N28A□2	0.44 (62)	140 × 10 ⁻⁷ (0.77)	2.8	0.16	0.72°	CVD528BR-K
PKP566N28A□2	0.81 (115)	270 × 10 ⁻⁷ (1.48)		0.24		
PKP568N28A□2	1.5 (210)	500 × 10 ⁻⁷ (2.7)		0.37		

● The box □ in the product name indicates the shaft **A** (single shaft) or **B** (double shaft).

*See page 64 for details on the recommended drivers.

Speed – Torque Characteristics (Reference Values) fs: Max. Starting Frequency

PKP564N28

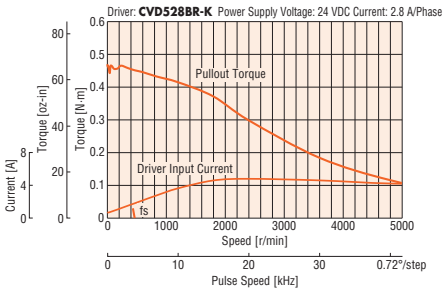

PKP566N28

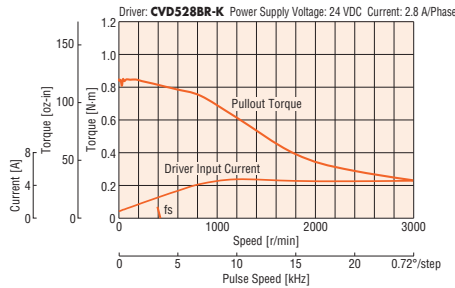

PKP568N28

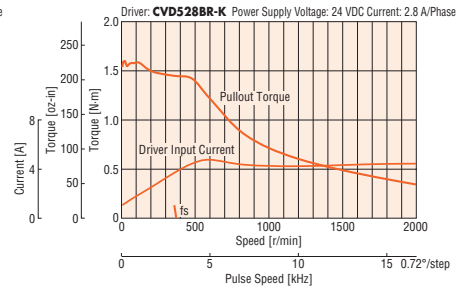

Note

- Data for the speed - torque characteristics is based on Oriental Motor's internal measurement conditions. If the conditions are changed, the characteristics may also change as a result.
- Depending on the driving conditions, a considerable amount of heat may be generated by the motor. Be sure to keep the motor case temperature at 100°C (212°F) max.
- Set the current of the driver so that it does not exceed the rated current of the motor.

Dimensions Unit = mm (in.)

Motor

2D & 3D CAD

Product Name	L1	L2	Mass kg (lb.)	2D CAD
PKP564N28AA2	39 (1.54)	—	0.43 (0.95)	B1257
PKP566N28AA2	54 (2.13)	—	0.67 (1.47)	B1258
PKP566N28BA2	—	77 (3.03)	—	—
PKP568N28AA2	76 (2.99)	—	1 (2.2)	B1259
PKP568N28BA2	—	99 (3.9)	—	—

- Applicable Connectors
- Connector Housing: MDF97-5S-3.5C (HIROSE ELECTRIC CO.,LTD)
- Contact: MDF97-22SC (HIROSE ELECTRIC CO.,LTD)
- Crimping Tool: HT801/MDF97-22S (HIROSE ELECTRIC CO.,LTD)

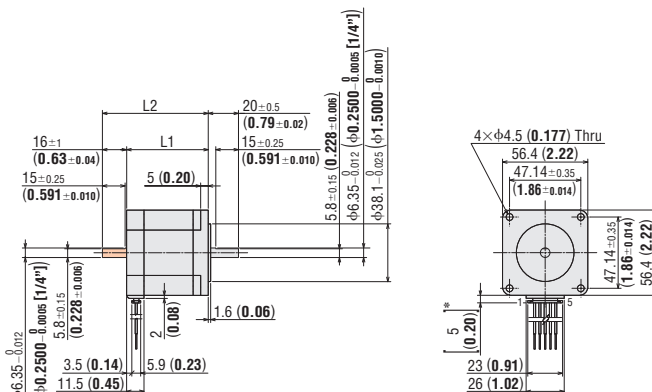

*With connection cable.

- These dimensions are for double shaft motors.
- For single shaft motors, ignore the shaft (□) areas.

Connection Cable (Sold separately)

Motor Connection Cables

Product Name	Length L m (in.)
LC5N06E	0.6 (24)

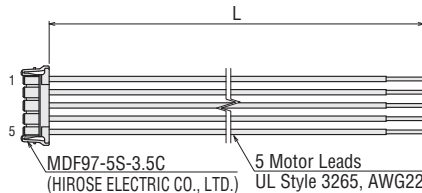

Motor Pinout

Motor Pinout: Model A

- Refer to page 60 for motor pinout.

Standard Type with Encoder Frame Size 56.4 mm (2.22 in.)

2-Phase
Motors
PKP

Specifications

Product Name	Maximum Holding Torque N·m (oz·in)	Rotor Inertia J: kg·m ² (oz·in ²)	Rated Current A/Phase	Winding Resistance Ω/Phase	Basic Step Angle	Recommended Driver Product Name*
PKP564N28A2-R2G ■	0.44 (62)	140 × 10 ⁻⁷ (0.77)	2.8	0.16	0.72°	CVD528BR-K
PKP566N28A2-R2G ■	0.81 (115)	270 × 10 ⁻⁷ (1.48)		0.24		
PKP568N28A2-R2G ■	1.5 (210)	500 × 10 ⁻⁷ (2.7)		0.37		

● The box ■ in the product name indicates the encoder output circuit type L (line driver output). The voltage output type will have no "■" in the product name.

*See page 60 for encoder specification.

*See page 64 for details on the recommended drivers.

Speed – Torque Characteristics (Reference Values) fs: Max. Starting Frequency

PKP564N28

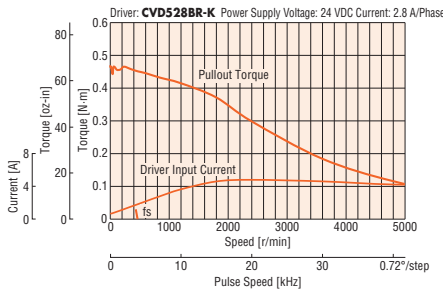

PKP566N28

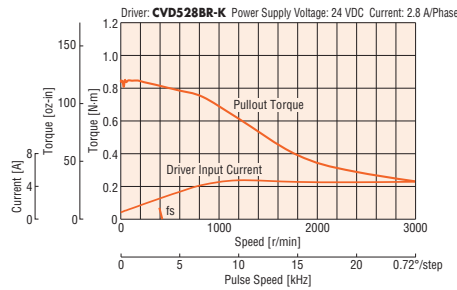

PKP568N28

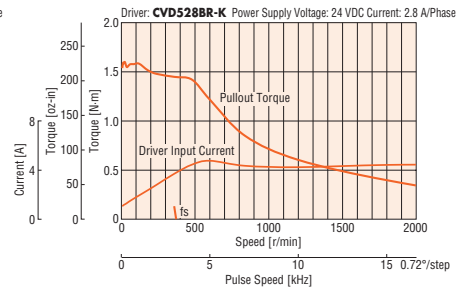

Note

- Data for the speed - torque characteristics is based on Oriental Motor's internal measurement conditions. If the conditions are changed, the characteristics may also change as a result.
- For the type with an encoder, to protect the encoder, be sure to keep the motor case temperature at 85°C (185°F) max.
- Set the current of the driver so that it does not exceed the rated current of the motor.

Dimensions Unit = mm (in.)

● Motor

2D & 3D CAD

Product Name	L	Mass kg (lb.)	2D CAD
PKP564N28A2-R2G ■	55.5 (2.19)	0.43 (0.95)	B1347
PKP566N28A2-R2G ■	70.5 (2.78)	0.67 (1.47)	B1348
PKP568N28A2-R2G ■	92.5 (3.64)	1 (2.2)	B1349

● Applicable Connectors

	Motor (HIROSE ELECTRIC CO.,LTD.)	Encoder (Molex)
Connector Housing	MDF97-5S-3.5C	51021-0800
Contact	MDF97-22SC	50079-8100
Crimping Tool	HT801/MDF97-22S	57067-3000

● Connection Cables (Sold separately)

◇ Motor Connection Cables

Product Name	Length L m (in.)
LC5N06E	0.6 (24)

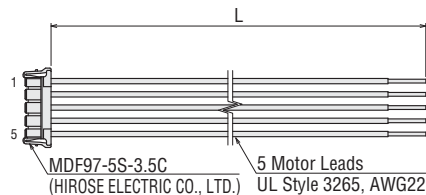

◇ Encoder Connection Cable

Product Name	Applicable Encoder	Length L m (ft.)
LCE05A-006	Voltage Output	0.6 (2)
LCE08A-006	Line Driver Output	0.6 (2)

◇ Voltage Output

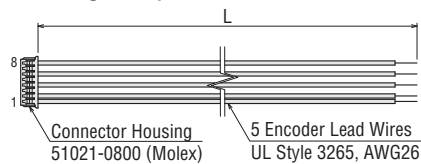

◇ Line Driver Output

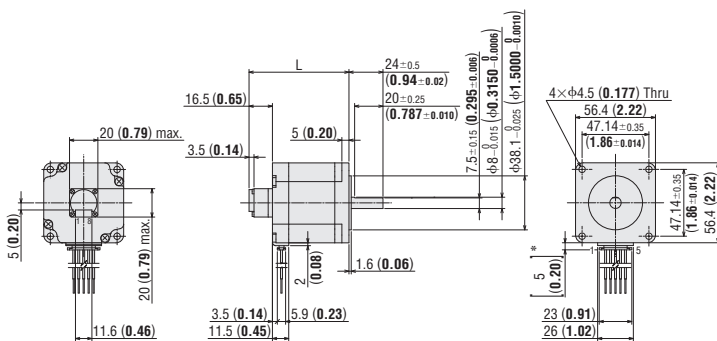
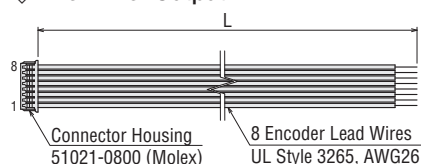

*With connection cable.

Motor Pinout

Motor Pinout: Model A

● Refer to page 60 for motor pinout.

Features
Product
Line

Product
Number
Product Line

Standard
Type

High-
Resolution
Type

Flat Type

SH
Geared
Type

General
Specifications/
Inner Wiring
Diagram of Motor

5-Phase
Motors
PKP

Features
Product
Line

Product
Number
Product Line

Standard
Type

High-
Resolution
Type

TS
Geared
Type

General
Specifications/
Inner Wiring
Diagram of Motor

Driver for
2-Phase/
5-Phase Motors

Accessories

Standard Type

Frame Size 60 mm (2.36 in.)

Specifications

Product Name	Maximum Holding Torque N·m (oz·in)	Rotor Inertia J: kg·m ² (oz·in ²)	Rated Current A/Phase	Winding Resistance Ω/Phase	Basic Step Angle	Recommended Driver Product Name*
PKP564FN24□2	0.66 (93)	160×10 ⁻⁷ (0.88)	2.4	0.28	0.72°	CVD524BR-K
PKP564FN38□2			3.8	0.12		CVD538BR-K
PKP566FN24□2	1.15 (163)	290×10 ⁻⁷ (1.59)	2.4	0.38		CVD524BR-K
PKP566FN38□2			3.8	0.16		CVD538BR-K
PKP569FN24□2	2.1 (290)	540×10 ⁻⁷ (3.0)	2.4	0.64		CVD524BR-K
PKP569FN38□2			3.8	0.22		CVD538BR-K

● The box □ in the product name indicates the shaft **A** (single shaft) or **B** (double shaft).

*See page 64 for details on the recommended drivers.

Speed – Torque Characteristics (Reference Values) *fs*: Max. Starting Frequency

PKP564FN24

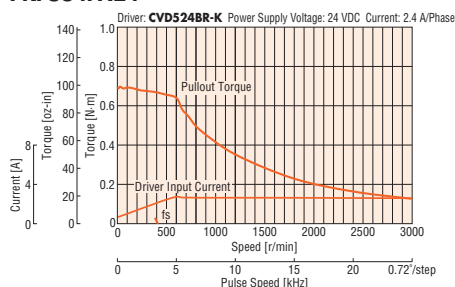

PKP566FN24

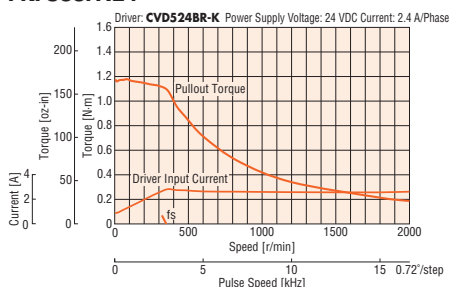

PKP569FN24

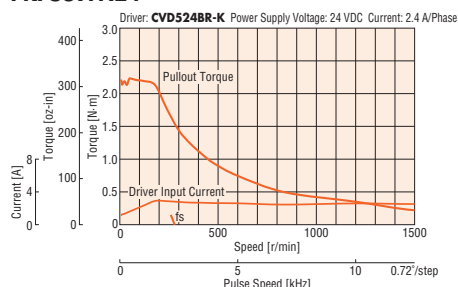

PKP564FN38

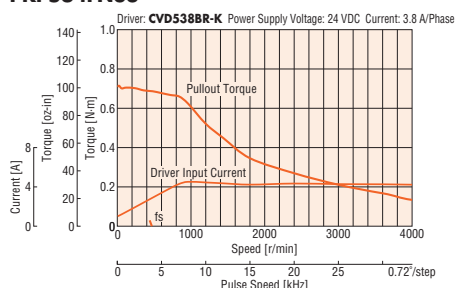

PKP566FN38

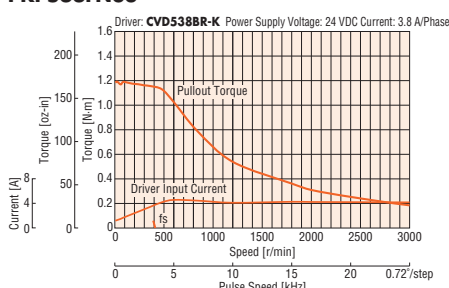

PKP569FN38

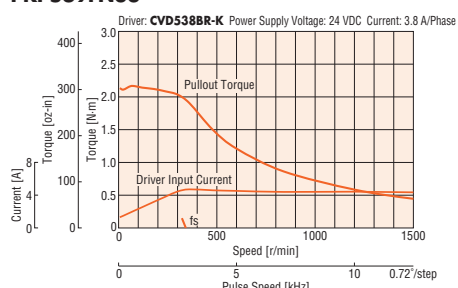

Note

- Data for the speed - torque characteristics is based on Oriental Motor's internal measurement conditions. If the conditions are changed, the characteristics may also change as a result.
- Depending on the driving conditions, a considerable amount of heat may be generated by the motor. Be sure to keep the motor case temperature at 100°C (212°F) max.
- Set the current of the driver so that it does not exceed the rated current of the motor.

Dimensions Unit = mm (in.)

Motor

2D & 3D CAD

Product Name	L1	L2	Mass kg (lb.)	2D CAD
PKP564FN24A2	44 (1.73)	—	0.56 (1.23)	B1252
PKP564FN24B2		65 (2.56)		
PKP564FN38A2	56 (2.20)	—	0.79 (1.74)	B1253
PKP564FN38B2		65 (2.56)		
PKP566FN24A2	84.5 (3.33)	—	1.3 (2.9)	B1254
PKP566FN24B2		77 (3.03)		
PKP566FN38A2	84.5 (3.33)	—	1.3 (2.9)	B1254
PKP566FN38B2		77 (3.03)		
PKP569FN24A2	84.5 (3.33)	—	1.3 (2.9)	B1254
PKP569FN24B2		105.5 (4.15)		
PKP569FN38A2	84.5 (3.33)	—	1.3 (2.9)	B1254
PKP569FN38B2		105.5 (4.15)		

*With connection cable.

- These dimensions are for double shaft motors.
- For single shaft motors, ignore the shaft the (□) areas.

Connection Cable (Sold separately)

Motor Connection Cables

Product Name	Length L m (in.)
LC5N06E	0.6 (24)

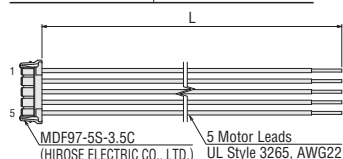

- Applicable Connectors
- Connector Housing: MDF97-5S-3.5C (HIROSE ELECTRIC CO.,LTD)
- Contact: MDF97-22SC (HIROSE ELECTRIC CO.,LTD)
- Crimping Tool: HT801/MDF97-22S (HIROSE ELECTRIC CO.,LTD)

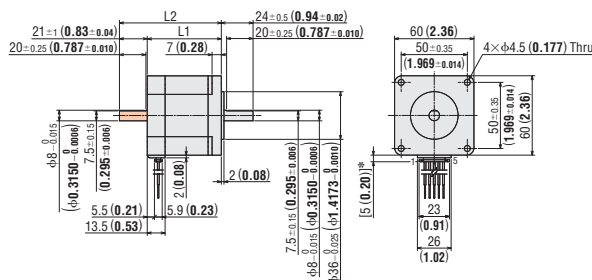

Motor Pinout

Motor Pinout: Model A

- Refer to page 60 for motor pinout.

Standard Type with Encoder

Frame Size 60 mm (2.36 in.)

Specifications

Product Name	Maximum Holding Torque N·m (oz·in)	Rotor Inertia J: kg·m ² (oz·in ²)	Rated Current A/Phase	Winding Resistance Ω/Phase	Basic Step Angle	Recommended Driver Product Name*
PKP564FN24A2-R2G	0.66 (93)	160×10 ⁻⁷ (0.88)	2.4	0.28	0.72°	CVD524BR-K
PKP564FN38A2-R2G			3.8	0.12		CVD538BR-K
PKP566FN24A2-R2G	1.15 (163)	290×10 ⁻⁷ (1.59)	2.4	0.38		CVD524BR-K
PKP566FN38A2-R2G			3.8	0.16		CVD538BR-K
PKP569FN24A2-R2G	2.1 (290)	540×10 ⁻⁷ (3.0)	2.4	0.64		CVD524BR-K
PKP569FN38A2-R2G			3.8	0.22		CVD538BR-K

● The box ■ in the product name indicates the encoder output circuit type L (line driver output). The voltage output type will have no "■" in the product name.

*See page 60 for encoder specification.

*See page 64 for details on the recommended drivers.

Speed – Torque Characteristics (Reference Values) fs: Max. Starting Frequency

PKP564FN24

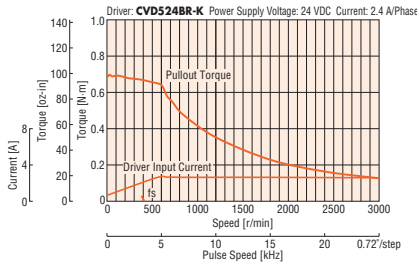

PKP566FN24

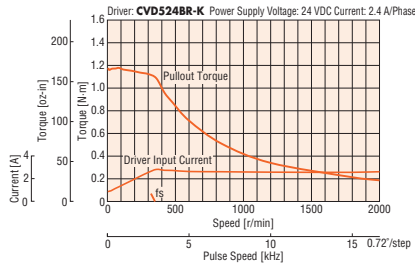

PKP569FN24

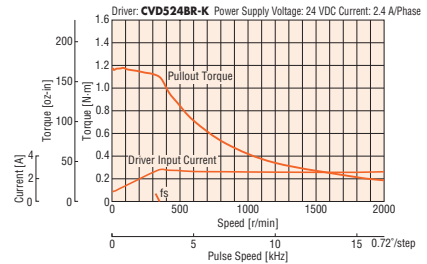

PKP564FN38

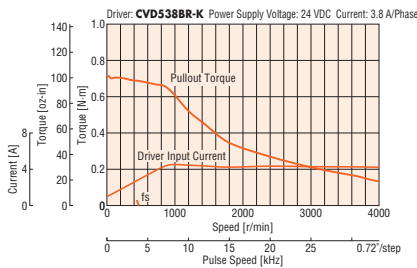

PKP566FN38

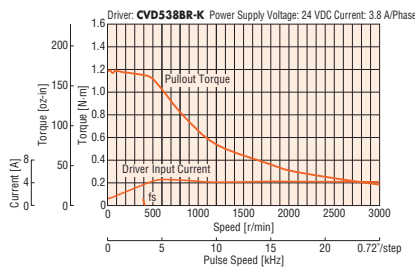

PKP569FN38

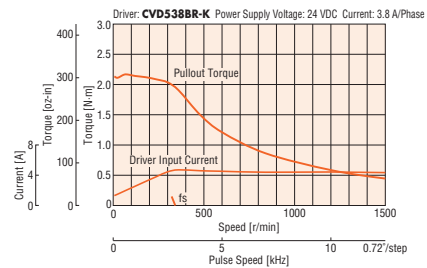

Note

- Data for the speed - torque characteristics is based on Oriental Motor's internal measurement conditions. If the conditions are changed, the characteristics may also change as a result.
- For the type with an encoder, to protect the encoder, be sure to keep the motor case temperature at 85°C (185°F) max.
- Set the current of the driver so that it does not exceed the rated current of the motor.

Dimensions Unit = mm (in.)

Motor

2D & 3D CAD

Product Name	L	Mass kg (lb.)	2D CAD
PKP564FN24A2-R2G	60.5 (2.38)	0.56 (1.23)	B1350
PKP564FN38A2-R2G			
PKP566FN24A2-R2G	72.5 (2.85)	0.79 (1.74)	B1351
PKP566FN38A2-R2G			
PKP569FN24A2-R2G	101 (3.98)	1.3 (2.9)	B1352
PKP569FN38A2-R2G			

Applicable Connectors

	Motor (HIROSE ELECTRIC CO.,LTD.)	Encoder (Molex)
Connector Housing	MDF97-5S-3.5C	51021-0800
Contact	MDF97-22SC	50079-8100
Crimping Tool	HT801/MDF97-22S	57067-3000

Connection Cables (Sold separately)

Motor Connection Cables

Product Name	Length L m (in.)
LC5N06E	0.6 (24)

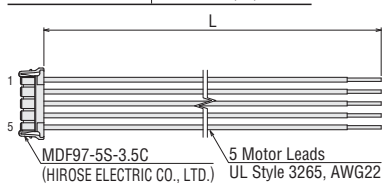

Motor Pinout

Motor Pinout: Model A

- Refer to page 60 for motor pinout.

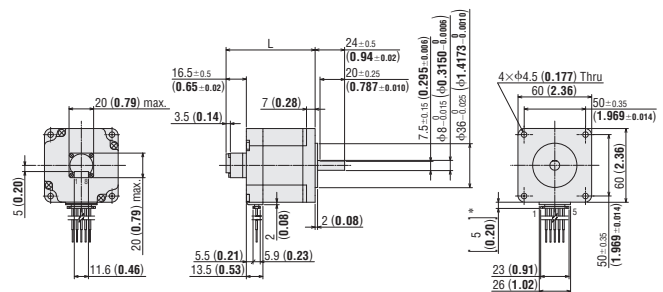

*With connection cable.

Encoder Connection Cable (Sold Separately)

Product Name	Applicable Encoder	Length L m (ft.)
LCE05A-006	Voltage Output	0.6 (2)
LCE08A-006	Line Driver Output	0.6 (2)

Voltage Output



Line Driver Output

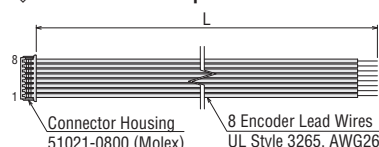

2-Phase
Motors
PKP

Features
Product
Line

Product
Number
Product Line

Standard
Type

High-
Resolution
Type

Flat Type

SH
Geared
Type

General
Specifications/
Inner Wiring
Diagram of Motor

5-Phase
Motors
PKP

Features
Product
Line

Product
Number
Product Line

Standard
Type

High-
Resolution
Type

TS
Geared
Type

General
Specifications/
Inner Wiring
Diagram of Motor

Driver for
2-Phase/
5-Phase Motors

Accessories

High-Resolution Type

Frame Size 42 mm (1.65 in.)

20 mm (0.79 in.)

28 mm (1.10 in.)

35 mm (1.38 in.)

42 mm (1.65 in.)

50 mm (1.97 in.)

56.4 mm (2.22 in.)

60 mm (2.36 in.)

85 mm (3.35 in.)

Specifications

Product Name	Max. Holding Torque	Rotor Inertia	Rated Current	Winding Resistance	Basic Step Angle	Recommended Driver Product Name*
Single Shaft	N·m (oz·in)	J: kg·m ² (oz·in ²)	A/Phase	Ω/Phase		
PKP544MN18□	0.26 (36)	60×10 ⁻⁷ (0.33)	1.8	0.51	0.36°	CVD518BR-K
PKP546MN18□	0.44 (62)	121×10 ⁻⁷ (0.66)		0.66		

● The box □ in the product name indicates the shaft **A** (single shaft) or **B** (double shaft).
*Refer to page 64 for details on the recommended driver.

Speed – Torque Characteristics (Reference values) fs: Max. Starting Frequency

PKP544MN18

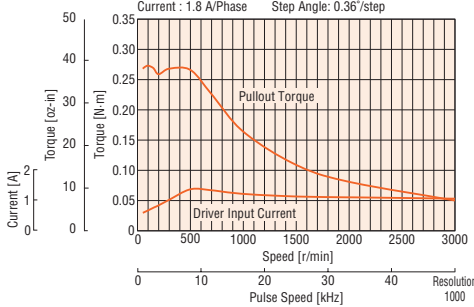

PKP546MN18

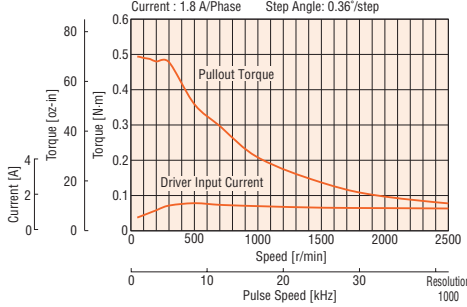

● The pulse input circuit responds up to 1 MHz with a pulse duty of 50%.

Note

● Depending on the driving conditions, a considerable amount of heat may be generated by the motor. Be sure to keep the motor case temperature under 100°C (212°F).

Dimensions Unit = mm (in.)

Motor Product Name	L1	L2	Mass kg (lb.)	CAD
PKP544MN18A	39 (1.54)	—	0.3 (0.66)	B1120
PKP544MN18B		54 (2.13)		
PKP546MN18A	59 (2.32)	—	0.5 (1.1)	B1121
PKP546MN18B		74 (2.91)		

● Applicable Connector
Connector housing: 51103-0500 (Molex)
Contact: 50351-8100 (Molex)
Crimp tool: 57295-5000 (Molex)

● Connection Cable (Sold separately)

◇ Connection Cable for Motor

Product Name	Length L m (ft.)
LC5N06B	0.6 (2)
LC5N10B	1 (3.3)

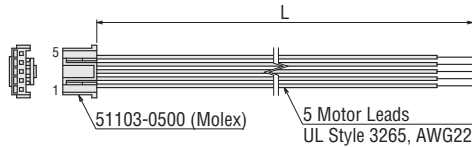

Motor Pinout

Motor Pinout: Model B

● Refer to page 60 for motor pinout.

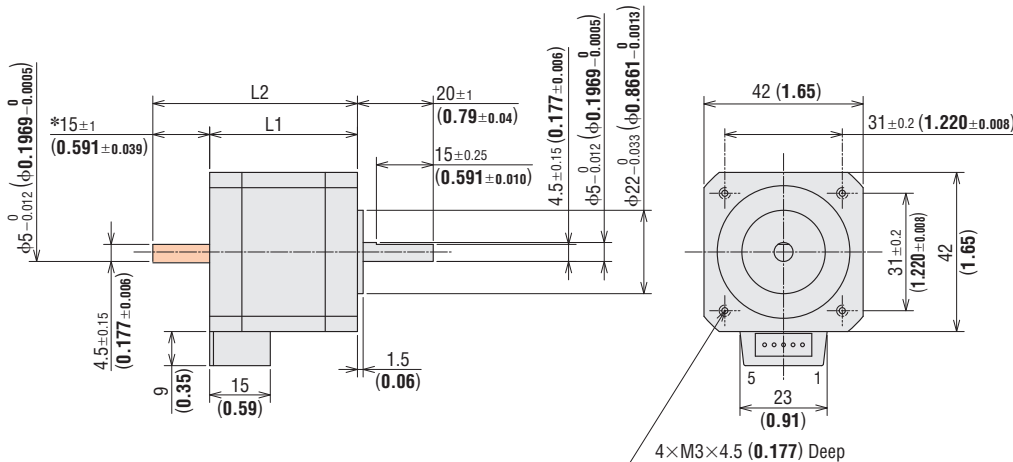

*The length of machining on the double shaft product is 15±0.25 (0.591±0.010).

High-Resolution Type

Frame Size 60 mm (2.36 in.)

Specifications

Product Name	Max. Holding Torque	Rotor Inertia	Rated Current	Winding Resistance	Basic Step Angle	Recommended Driver Product Name*
Single Shaft	N·m (oz·in)	J: kg·m ² (oz·in ²)	A/Phase	Ω/Phase		
PKP564FMN24□	0.78 (110)	310×10^{-7} (1.70)	2.4	0.32	0.36°	CVD524BR-K
PKP566FMN24□	1.25 (177)	490×10^{-7} (2.7)		0.4		
PKP569FMN24□	2.3 (320)	970×10^{-7} (5.3)		0.66		

● The box □ in the product name indicates the shaft **A** (single shaft) or **B** (double shaft).

*Refer to page 64 for details on the recommended driver.

Speed – Torque Characteristics (Reference values) fs: Max. Starting Frequency

PKP564FMN24

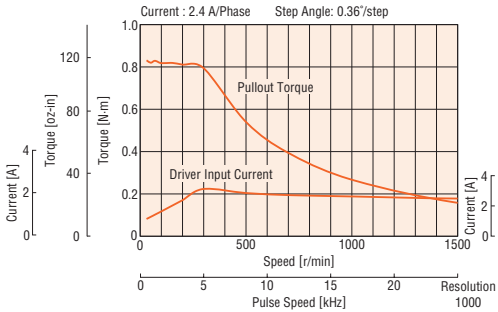

PKP566FMN24

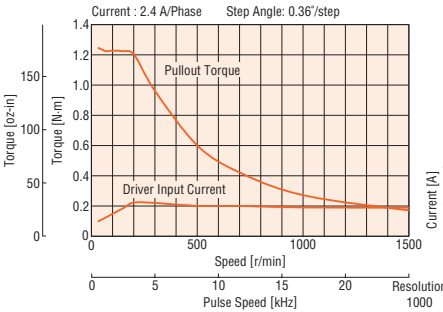

PKP569FMN24

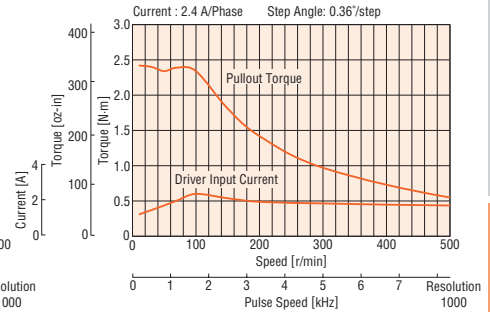

● The pulse input circuit responds up to 1 MHz with a pulse duty of 50%.

Note

● Depending on the driving conditions, a considerable amount of heat may be generated by the motor. Be sure to keep the motor case temperature under 100°C (212°F).

Motor Product Name	L1	L2	L3	φD	Mass kg (lb.)	CAD
PKP564FMN24A	46.5 (1.83)	—	7.5±0.15 (0.295±0.006)		0.65 (1.43)	B1125
PKP564FMN24B	69.5 (2.74)	—				
PKP566FMN24A	56 (2.20)	—	9.5±0.15 (0.374±0.006)		0.87 (1.91)	B1126
PKP566FMN24B	79 (3.11)	—				
PKP569FMN24A	87 (3.43)	—	110 (4.33)		1.5 (3.3)	B1127
PKP569FMN24B	110 (4.33)	—				

● A 0.6 m (2 ft.) motor connection cable is included with each package : **LC5N06C**

● Applicable Connector

Connector housing: 51144-0500 (Molex)

Contact: 50539-8100 (Molex)

Crimp tool: 57189-5000 (Molex)

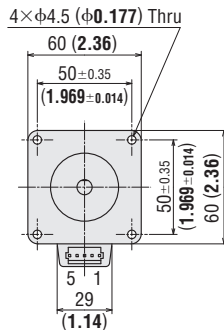
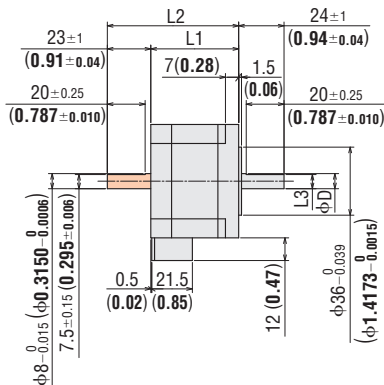

Connection Cable (Sold separately)

◇ Connection Cable for Motor

Product Name	Length L m (ft.)
LC5N06C	0.6 (2)
LC5N10C	1 (3.3)

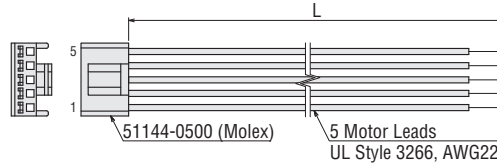

Motor Pinout

Motor Pinout: Model B

● Refer to page 60 for motor pinout.

2-Phase Motors PKP

Features Product Line

Product Number Product Line

Standard Type

High-Resolution Type

Flat Type

SH Geared Type

General Specifications/ Inner Wiring Diagram of Motor

5-Phase Motors PKP

Features Product Line

Product Number Product Line

Standard Type

High-Resolution Type

TS Geared Type

General Specifications/ Inner Wiring Diagram of Motor

Driver for 2-Phase/ 5-Phase Motors

Accessories

TS Geared Type

Frame Size 42 mm (1.65 in.)

Specifications

Product Name	Maximum Holding Torque N·m (lb·in)	Rotor Inertia J: kg·m ² (oz·in ²)	Rated Current A/Phase	Winding Resistance Ω/Phase	Basic Step Angle	Gear Ratio	Permissible Torque N·m (lb·in)	Maximum Instantaneous Torque N·m (lb·in)	Speed Range r/min	Backlash arcmin	Recommended Driver Product Name*
PKP544N18□2-TS3.6	0.65 (5.7)	55×10 ⁻⁷ (0.3)	1.8	0.48	0.2°	3.6	0.65 (5.7)	0.85 (7.5)	0-833	45 (0.75°)	CVD518BR-K
PKP544N18□2-TS7.2	1.2 (10.6)				0.1°	7.2	1.2 (10.6)	1.6 (14.1)	0-416	25 (0.42°)	
PKP544N18□2-TS10	1.7 (15)				0.072°	10	1.7 (15)	2 (17.7)	0-300		
PKP543N18□2-TS20	2 (17.7)	35×10 ⁻⁷ (0.191)	0.4	0.036°	20	2 (17.7)	3 (26)	0-150	15 (0.25°)		
PKP543N18□2-TS30	2.3 (20)									0.024°	

● The box □ in the product name indicates the shaft **A** (single shaft) or **B** (double shaft).

*See page 64 for details on the recommended drivers.

Speed – Torque Characteristics (Reference Values) *fs*: Max. Starting Frequency

PKP544N18A2-TS3.6/PKP544N18B2-TS3.6

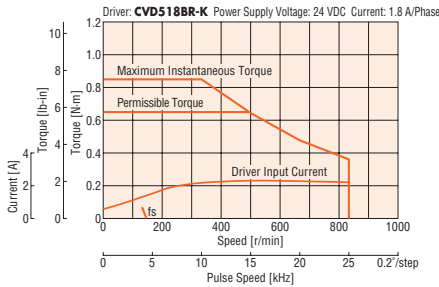

PKP544N18A2-TS7.2/PKP544N18B2-TS7.2

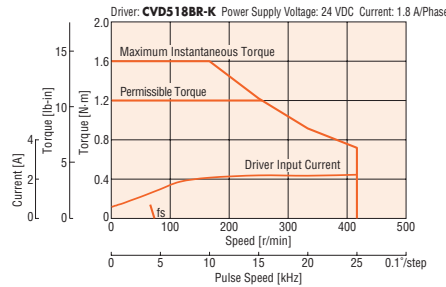

PKP544N18A2-TS10/PKP544N18B2-TS10

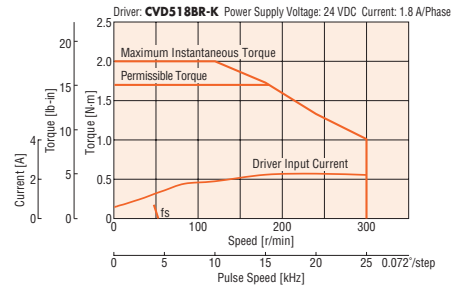

PKP543N18A2-TS20/PKP543N18B2-TS20

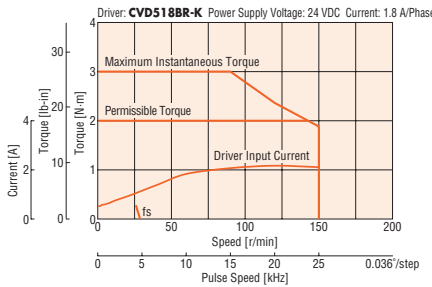

PKP543N18A2-TS30/PKP543N18B2-TS30

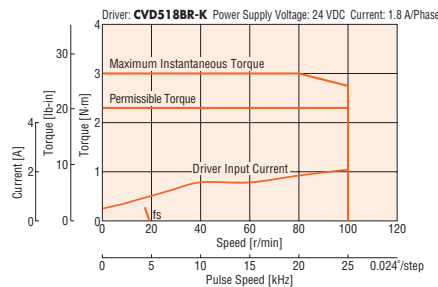

Note

- Data for the speed - torque characteristics is based on Oriental Motor's internal measurement conditions. If the conditions are changed, the characteristics may also change as a result.
- Depending on the driving conditions, a considerable amount of heat may be generated by the motor. Be sure to keep the motor case temperature at 100°C (212°F) max.
- Set the current of the driver so that it does not exceed the rated current of the motor.

Dimensions Unit = mm (in.)

● Motor

Product Name	Gear Ratio	L	Mass kg (lb.)	2D CAD
PKP544N18A2-TS□	3.6, 7.2, 10	70.5 (2.78)	0.41 (0.9)	B1362
PKP544N18B2-TS□				
PKP543N18A2-TS□				
PKP543N18B2-TS□	20, 30	64.5 (2.59)	0.36 (0.79)	B1363

● The box □ in the product name indicates a number representing the gear ratio.

● Applicable Connectors

Connector Housing: MDF97-5S-3.5C (HIROSE ELECTRIC CO.,LTD)

Contact: MDF97-22SC (HIROSE ELECTRIC CO.,LTD)

Crimping Tool: HT801/MDF97-22S (HIROSE ELECTRIC CO.,LTD)

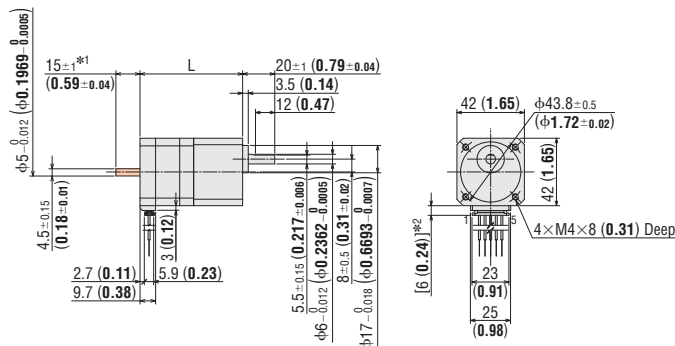

● Connection Cable (Sold separately)

◇ Connection Cable for Motor

Product Name	Length L m (in.)
LC5N06E	0.6 (24)

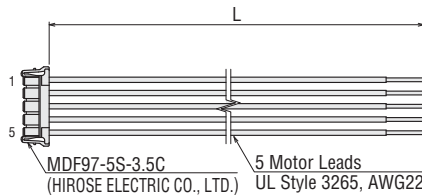

Motor Pin Assignments

Motor Pin Assignments: Model A

● Refer to page 60 for inner wiring diagram of motor.

TS Geared Type

Frame Size 60 mm (2.36 in.)

2-Phase Motors PKP

Specifications

Product Name	Maximum Holding Torque N·m (lb·in)	Rotor Inertia J: kg·m ² (oz·in ²)	Rated Current A/Phase	Winding Resistance Ω/Phase	Basic Step Angle	Gear Ratio	Permissible Torque N·m (lb·in)	Maximum Instantaneous Torque N·m (lb·in)	Speed Range r/min	Backlash arcmin	Recommended Driver Product Name*
PKP566N28□2-TS3.6	1.8 (15.9)	270×10 ⁻⁷ (1.48)	2.8	0.24	0.2°	3.6	1.8 (15.9)	2.5 (22)	0-833	35 (0.59°)	CVD528BR-K
PKP566N28□2-TS7.2	3 (26)				0.1°	7.2	3 (26)	4.5 (39)	0-416		
PKP566N28□2-TS10	4 (35)				0.072°	10	4 (35)	6 (53)	0-300		
PKP564N28□2-TS20	5 (44)	140×10 ⁻⁷ (0.77)		0.16	0.036°	20	5 (44)	8 (70)	0-150	10 (0.17°)	
PKP564N28□2-TS30	6 (53)				0.024°	30	6 (53)	10 (88)	0-100		

● The box □ in the product name indicates the shaft **A** (single shaft) or **B** (double shaft).

*See page 64 for details on the recommended drivers.

Speed - Torque Characteristics (Reference Values) fs: Max. Starting Frequency

PKP566N28A2-TS3.6/PKP566N28B2-TS3.6

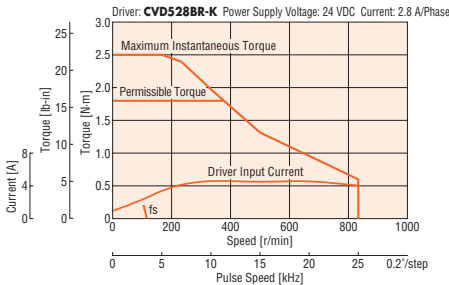

PKP566N28A2-TS7.2/PKP566N28B2-TS7.2

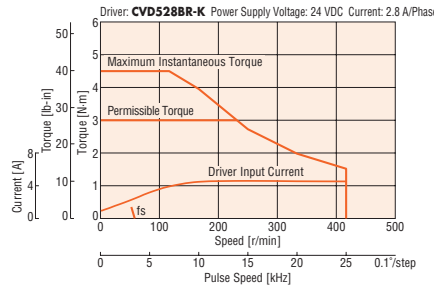

PKP566N28A2-TS10/PKP566N28B2-TS10

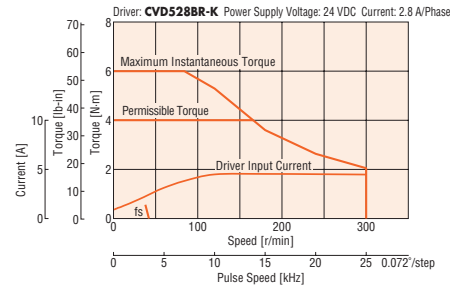

PKP564N28A2-TS20/PKP564N28B2-TS20

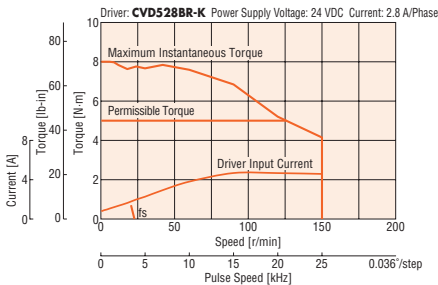

PKP564N28A2-TS30/PKP564N28B2-TS30

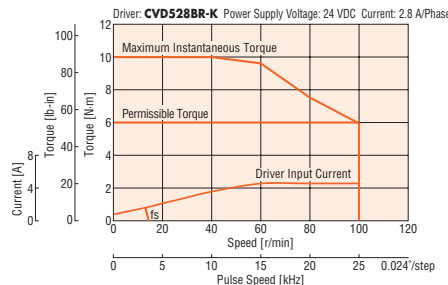

Note

- Data for the speed - torque characteristics is based on Oriental Motor's internal measurement conditions. If the conditions are changed, the characteristics may also change as a result.
- Depending on the driving conditions, a considerable amount of heat may be generated by the motor. Be sure to keep the motor case temperature at 100°C (212°F) max.
- Set the current of the driver so that it does not exceed the rated current of the motor.

Dimensions Unit = mm (in.)

● Motor

Product Name	Gear Ratio	L	Mass kg (lb.)	2D CAD
PKP566N28A2-TS□	3.6, 7.2, 10	98 (3.86)	0.99 (2.2)	B1364
PKP566N28B2-TS□				
PKP564N28A2-TS□	20, 30	83 (3.27)	0.78 (1.72)	B1365
PKP564N28B2-TS□				

- The box □ in the product name indicates a number representing the gear ratio.
- Mounting Screw: M4×60 (2.36 in.) P0.7 (4 screws included)
- Applicable Connectors
Connector Housing: MDF97-5S-3.5C (HIROSE ELECTRIC CO.,LTD)
Contact: MDF97-22SC (HIROSE ELECTRIC CO.,LTD)
Crimping Tool: HT801/MDF97-22S (HIROSE ELECTRIC CO.,LTD)

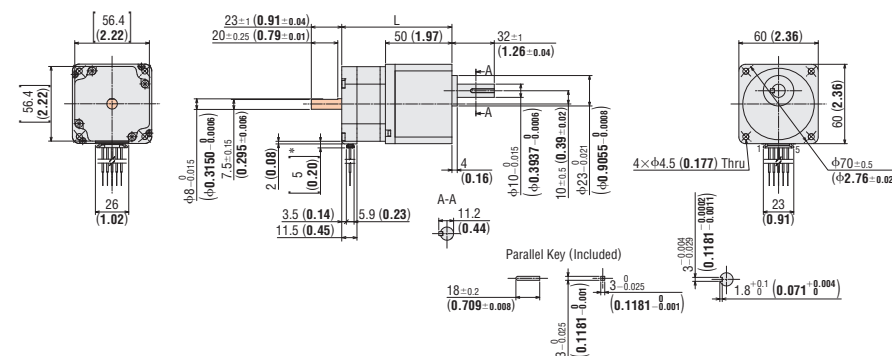

● Connection Cable (Sold separately)

◇ Connection Cable for Motor

Product Name	Length L m (in.)
LC5N06E	0.6 (24)

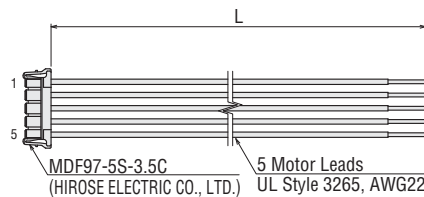

Motor Pin Assignments

Motor Pin Assignments: Model A

- Refer to page 60 for inner wiring diagram of motor.

Features Product Line

Product Number Product Line

Standard Type

High-Resolution Type

Flat Type

SH Geared Type

General Specifications/Inner Wiring Diagram of Motor

5-Phase Motors PKP

Features Product Line

Product Number Product Line

Standard Type

High-Resolution Type

TS Geared Type

General Specifications/Inner Wiring Diagram of Motor

Driver for 2-Phase/5-Phase Motors

Accessories

General Specifications

Specifications		Motor
Thermal Class		130 (B)
Insulation Resistance		The measured value is 100 MΩ min. when a 500 VDC megger is applied between the windings and the case under normal ambient temperature and humidity.
Dielectric Strength		No abnormalities are observed, even when applying voltage between the windings and the case for 1 minute under normal ambient temperature and humidity with the following conditions. • PKP52 □, PKP54 □: AC 0.5 kV 50/60 Hz • PKP56 □: AC 1.0 kV 50/60 Hz • PKP56 □ FMN : AC 1.5 kV 50/60 Hz
Operating Environment (In operation)	Ambient Temperature	-10~+50°C (+14~+122°F) (Non-freezing)
	Ambient Humidity	85% or less (Non-condensing)
	Atmosphere	No corrosive gases or dust. The product should not be exposed to water, oil or other liquids.
Temperature Rise		Winding temperature rise 80°C (176°F) max. (Based on Oriental Motor's internal measurement conditions)
Stop Position Accuracy*1		Standard Type: ±3 arcmin (±0.05°) High-Resolution Type: ±2 arcmin (±0.034°)
Shaft Runout		0.05 T.I.R (mm)*4
Radial Play*2		0.025 mm or less [Load 5 N (1.12 lb.)]
Axial Play*3		0.075 mm or less [Load 10 N (2.2 lb.)] [PKP52 □ is load 2.5 N (0.566 lb.)]
Concentricity of Installation Pilot to the Shaft		0.075 T.I.R (mm)*4
Perpendicularity of Installation Surface to the Shaft		0.075 T.I.R (mm)*4

*1 This value is for a full step under no load. (The value changes with the size of the load.)

*2 Radial Play: Displacement in shaft position in the radial direction when a 5 N (1.12 lb.) load is applied perpendicular to the tip of the motor shaft.

*3 Axial Play: Displacement in shaft position in the axial direction when a 10 N (2.2 lb.) [**PKP52**□ is 2.5 N (0.566 lb.)] load is applied to the motor shaft in the axial direction.

*4 T. I. R. (Total Indicator Reading): The total dial gauge reading when the measurement section is rotated once around the reference axis center.

Note

- Do not measure insulation resistance or perform a dielectric strength test while the motor and driver are connected. Also, do not conduct these tests on the motor encoder section.

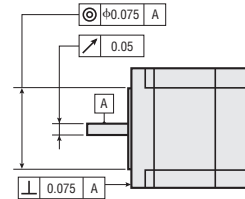

Encoder Specifications

Encoder Product Name	R2GL	R2G
Resolution	500P/R	500P/R
Output Circuit Type	Line Driver Output*	Voltage Output
Output Mode	Incremental	
Output Signal	A Phase, B Phase, and Z Phase (3ch)	
Power Supply Voltage	5 VDC ±10%	
Current	30 mA max.	45 mA max.

*26C31 or equivalent

Motor Pinout

Motor Model Type	Pinout/Lead Wire Color													
Model A		<table border="1"> <thead> <tr> <th>Pin No.</th> <th>Lead Wire Color*</th> </tr> </thead> <tbody> <tr> <td>5</td> <td>Blue</td> </tr> <tr> <td>4</td> <td>Red</td> </tr> <tr> <td>3</td> <td>Orange</td> </tr> <tr> <td>2</td> <td>Green</td> </tr> <tr> <td>1</td> <td>Black</td> </tr> </tbody> </table>	Pin No.	Lead Wire Color*	5	Blue	4	Red	3	Orange	2	Green	1	Black
		Pin No.	Lead Wire Color*											
5	Blue													
4	Red													
3	Orange													
2	Green													
1	Black													
*The colors of the lead wires are the colors of the separately sold connection cables.														
Model B		<table border="1"> <thead> <tr> <th>Pin No.</th> <th>Lead Wire Color*</th> </tr> </thead> <tbody> <tr> <td>1</td> <td>Blue</td> </tr> <tr> <td>2</td> <td>Red</td> </tr> <tr> <td>3</td> <td>Orange</td> </tr> <tr> <td>4</td> <td>Green</td> </tr> <tr> <td>5</td> <td>Black</td> </tr> </tbody> </table>	Pin No.	Lead Wire Color*	1	Blue	2	Red	3	Orange	4	Green	5	Black
		Pin No.	Lead Wire Color*											
1	Blue													
2	Red													
3	Orange													
4	Green													
5	Black													
*The colors of the lead wires are the colors of the separately sold connection cables.														
Model C		<table border="1"> <thead> <tr> <th>Lead Wire Color</th> </tr> </thead> <tbody> <tr> <td>Blue</td> </tr> <tr> <td>Red</td> </tr> <tr> <td>Orange</td> </tr> <tr> <td>Green</td> </tr> <tr> <td>Black</td> </tr> </tbody> </table>	Lead Wire Color	Blue	Red	Orange	Green	Black						
		Lead Wire Color												
Blue														
Red														
Orange														
Green														
Black														
*The colors of the lead wires are the colors of the separately sold connection cables.														

Rotation Direction

This indicates the rotation direction when viewed from the output shaft side of the motor. The rotation direction of the output gear shaft relative to the standard type motor output shaft varies depending on the gear type and gear ratio. Please check the following table.

Geared Type		Gear Ratio	The rotation direction when viewed from the output shaft side of the motor
TS Geared Type	Frame Size 42 mm (1.65 in.), 60 mm (2.36 in.)	3.6, 7.2, 10	Same direction
		20, 30	Opposite direction

Standard Type Motor

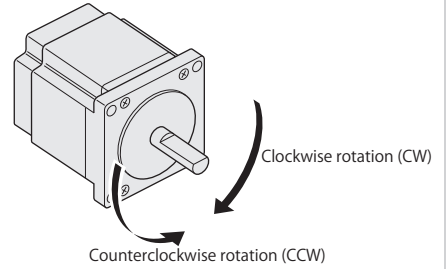

Permissible Radial Load and Permissible Axial Load

Unit: N (lb.)

Type	Motor Frame Size	Product Name	Gear Ratio	Permissible Radial Load					Permissible Axial Load
				Distance from Shaft End [mm (in.)]					
				0 (0)	5 (0.2)	10 (0.39)	15 (0.59)	20 (0.79)	
Standard Type	28 mm (1.10 in.)	PKP523, PKP525	—	25 (5.6)	34 (7.6)	52 (11.7)	—	—	5 (1.12)
	42 mm (1.65 in.)	PKP543, PKP544, PKP545, PKP546	—	35 (7.8)	44 (9.9)	58 (13)	85 (19.1)	—	15 (3.3)
	56.4 mm (2.22 in.)	PKP564, PKP566, PKP568	—	90 (20)	100 (22)	130 (29)	180 (40)	270 (60)	30 (6.7)
	60 mm (2.36 in.)	PKP564, PKP566, PKP569	—	90 (20)	100 (22)	130 (29)	180 (40)	270 (60)	30 (6.7)
High-Resolution Type	42 mm (1.65 in.)	PKP544, PKP546	—	20 (4.5)	25 (5.6)	34 (7.6)	52 (11.7)	—	10 (2.2)
	60 mm (2.36 in.)	PKP564, PKP566, PKP569	—	90 (20)	100 (22)	130 (29)	180 (40)	270 (60)	20 (4.5)
TS Geared Type	42 mm (1.65 in.)	PKP544	3.6, 7.2, 10	20 (4.5)	30 (6.7)	40 (9)	50 (11.2)	—	15 (3.3)
		PKP543	20, 30	40 (9)	50 (11.2)	60 (13.5)	70 (15.7)	—	
	60 mm (2.36 in.)	PKP566	3.6, 7.2, 10	120 (27)	135 (30)	150 (33.7)	165 (37)	180 (40)	40 (9)
		PKP564	20, 30	170 (38)	185 (41)	200 (45)	215 (48)	230 (51)	

Radial Load and Axial Load

Distance from Shaft End [mm (in.)]

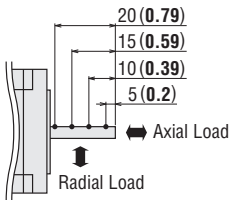

2-Phase
Motors
PKP

Features
Product
Line

Product
Number
Product Line

Standard
Type

High-
Resolution
Type

Flat Type

SH
Geared
Type

General
Specifications/
Inner Wiring
Diagram of Motor

5-Phase
Motors
PKP

Features
Product
Line

Product
Number
Product Line

Standard
Type

High-
Resolution
Type

TS
Geared
Type

General
Specifications/
Inner Wiring
Diagram of Motor

Driver for
2-Phase/
5-Phase Motors

Accessories

Bipolar Driver for 2-Phase Stepper Motors Driver for 5-Phase Stepper Motors

2-Phase
Bipolar
5-Phase

Cables

● For detailed information about regulations and standards, please refer to the Oriental Motor website.

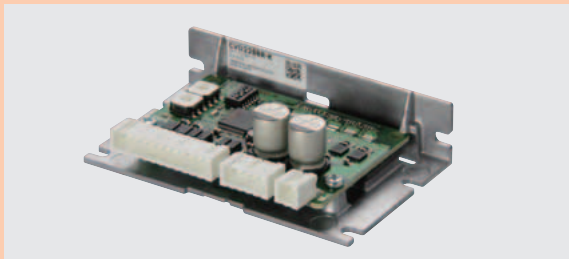

This is a DC power supply input driver for stepper motors. A bipolar driver for 2-phase stepper motors and a driver for 5-phase stepper motors are available. Using this microstepping driver reduces vibration and noise.



See Full Product Details Online
www.orientalmotor.com

● Manual

● Specifications

● Dimensions





● CAD

● Characteristics

● Connection and Operation

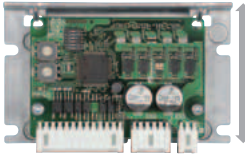
Features and Types

● Bipolar Driver for 2-Phase Stepper Motors Driver for 5-Phase Stepper Motors

Driver Type	External View	Introduction	Driver Installation Direction
<ul style="list-style-type: none"> ● Bipolar Driver for 2-Phase Stepper Motors ● Driver for 5-Phase Stepper Motors  <p>52.5 mm (2.07 in.)</p>  <p>24.5 mm (0.96 in.)</p> <p>85 mm (3.35 in.)</p> <ul style="list-style-type: none"> • Mass 20 g (0.71 oz.)~70 g (2.47 oz.) (The value differs according to the driver type.) ● The driver cannot be shared by both a 2-Phase stepper motors and 5-Phase stepper motors. Each must use its respective dedicated driver. 	<p>The connector points outward.</p> 	<ul style="list-style-type: none"> • Compact and lightweight driver with full-time microstepping. • Using the smooth drive function reduces the vibration and noise more than conventional products. 	<ul style="list-style-type: none"> • Horizontal installation • Vertical installation
<p>Without Installation Plate</p>	<p>The connector points upward.</p> 	<ul style="list-style-type: none"> • The driver is equipped with a protective function that enables you to find driver errors early. • Run current can be easily set with the digital switch. 	

● Additional Product Line

◇ Bipolar Driver S Type for 2-Phase/5-Phase Stepper Motors



This is a compact board mounting type driver. For details, please contact the nearest Oriental Motor sales office.

◇ CVK Series SC Type Driver

This driver allows the stepper motors to operate like a speed control motor.

It can be operated easily by using the forward and reverse inputs only.

- No Pulse Generator Required
- Available for Setting in Two Speeds
- Compact and High-Torque
- Enhanced Repeatability of the Stop Position
- Possible to Hold the Load at Standstill

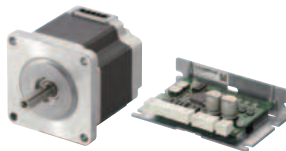

For details, please contact the nearest Oriental Motor sales office.

Low Vibration with Full-Time Microstepping

Low vibration and noise reduction have been achieved across all speed ranges by significantly improving the vibration level with the use of a fully digital-controlled full-time microstep driver. The **CVD** 5 phase driver and motor has further improved vibration characteristic.

●Reduced Step Vibration

The new smooth drive control with higher current control increases the basic step angle to a maximum resolution of 2048. As a result, a reduction in step vibration in the low-speed range is achieved.

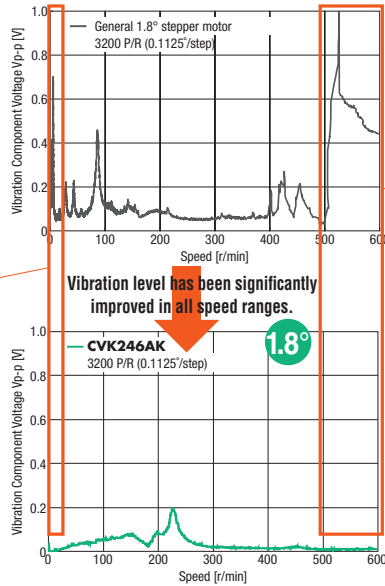

●Vibration Suppression Control

Common vibration that occurs in the mid-speed range has been suppressed. This enables more stable torque characteristics.

CVD/PKP

Vibration characteristics for 0.72°/0.36° stepper motors have been further improved.

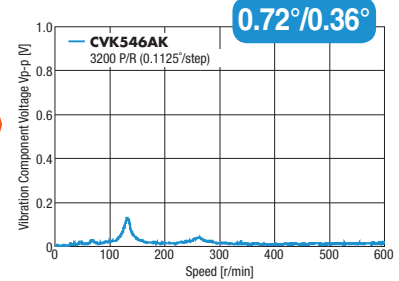

For High Positioning Accuracy Use a 0.72°/0.36° Stepper Motor

In general, stopping accuracy tends to be lower during microstep operation* than full step operation and this effect is more noticeable in a 1.8° motor. In this situation, using a **CVD** 5 phase driver and motor enables a higher positioning accuracy.

*Max. resolution 125000 P/R

●For a General 1.8° Stepper Motor

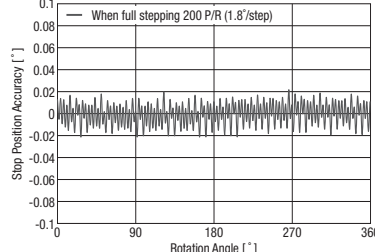

Microstepping reduces stopping accuracy.

0.72°/0.36°

●For a CVD driver, 0.72°/0.36° Stepper Motor

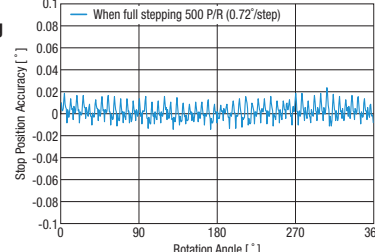

Microstepping does not reduce stopping accuracy.

●Stopping Accuracy

0.72° stepper motor standard type ±0.05° (±3 min)
0.36° stepper motor high-resolution type ±0.034° (±2 min)

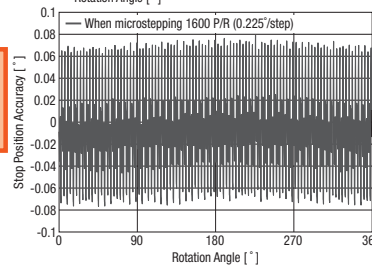

CVD/PKP
High positioning accuracy is now possible with 0.72°/0.36° stepper motors

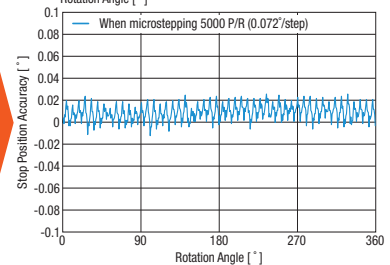

There's a Wide Choice with 1.8° and 0.72°/0.36° Stepper Motors

The size, installation and I/O connectors for the **CVD** drivers and 1.8° or 0.72°/0.36° motors are the same. Because of this, it is easy to evaluate and select the proper package for the requirement.

*The driver for a 1.8° stepper motor and the driver for a 0.72°/0.36° stepper motor are not interchangeable. Each motor type has a dedicated driver. Use the Step Angle Setting Switch to set the proper resolution without changing your controller's pulse output.

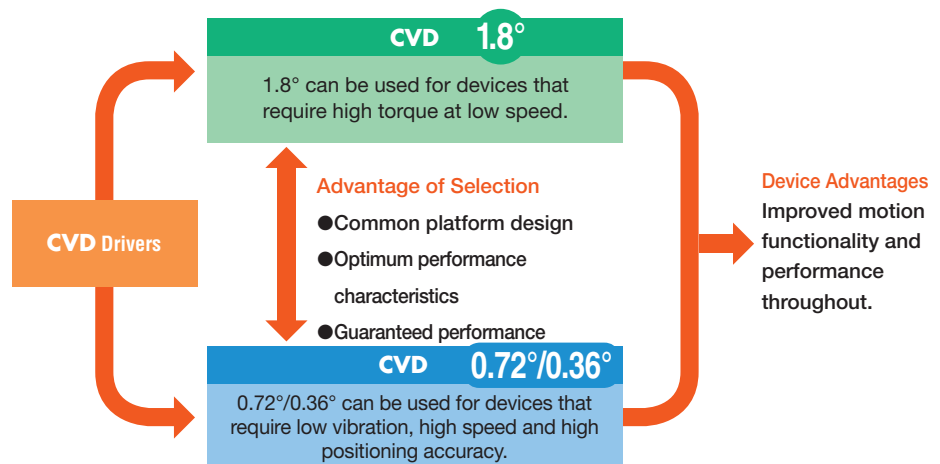

Bipolar Driver for 2-Phase Stepper Motors Driver for 5-Phase Stepper Motors

2-Phase
Bipolar
5-Phase

Cables

Product Number

CVD 2 23 F B R - K

① ② ③ ④ ⑤ ⑥ ⑦

①	Driver Type
②	2: 2-Phase 5: 5-Phase
③	Rated Current
④	Driver Identification
⑤	Driver Shape B: With Installation Plate Blank: Without Installation Plate
⑥	Connector Shape R: Right Angle
⑦	Power Supply Input K: DC Power Supply

Product Line

We have prepared a connection cable set (sold separately) consisting of motor, power supply, and I/O signal cables. The connectors are already crimped, which makes them easy to wire without crimp tools.

● Bipolar Driver for 2-Phase Stepper Motors

◇ Right Angle Type with Installation Plate

Product Name	List Price
CVD205BR-K	\$135.00
CVD206BR-K	
CVD215BR-K	
CVD223BR-K	
CVD223FBR-K	
CVD228BR-K	
CVD242BR-K	\$150.00
CVD245BR-K	

◇ Without Installation Plate

Product Name	List Price
CVD205-K	\$130.00
CVD206-K	
CVD215-K	
CVD223-K	
CVD223F-K	
CVD228-K	

● Driver for 5-Phase Stepper Motors

◇ Right Angle Type with Installation Plate

Product Name	List Price
CVD503BR-K	\$145.00
CVD507BR-K	
CVD512BR-K	
CVD514BR-K	
CVD518BR-K	
CVD524BR-K	
CVD528BR-K	
CVD538BR-K	

◇ Without Installation Plate

Product Name	List Price
CVD503-K	\$140.00
CVD507-K	
CVD512-K	
CVD514-K	
CVD518-K	
CVD524-K	

Included

Type	Connector for Driver Connection	Operating Manual
Common to All Types	CN1 Connector (1 pc.), CN2 Connector (1 pc.), CN3 Connector (1 pc.)	1 Copy

Specifications

● Bipolar Driver for 2-Phase Stepper Motors



Product Name	CVD205 □□-K	CVD206 □□-K	CVD215 □□-K	CVD223 □□-K CVD223F □□-K	CVD228 □□-K	CVD242B □-K	CVD245B □-K
Driving Method	Microstep Drive, Bipolar, Constant Current Drive Method						
Motor Driving Current (Factory Setting)	0.5 A/Phase	0.6 A/Phase	1.5 A/Phase	2.3 A/Phase	2.8 A/Phase	4.2 A/Phase	4.5 A/Phase
Power Supply Voltage	24 VDC±10%						
Input Current	A	0.5	0.5	1.9	2.0	3.0	3.6
Max. Input Pulse Frequency	Line driver output by programmable controller: 1 MHz (When the pulse duty is 50%) Open-collector output by programmable controller: 250 kHz (When the pulse duty is 50%) Negative Logic Pulse Input						
Operating Environment (In operation)	Ambient Temperature	0 to +50°C (+32 to +122°F) (Non-freezing)					
	Ambient Humidity	85% or less (Non-condensing)					
	Surrounding Atmosphere	No corrosive gas or dust. No water or oil.					

● For the right angle type with an installation plate, the box □ in the product name indicates the driver shape **B** (with installation plate), the box □ indicates the connector shape **R** (right angle).

● Driver for 5-Phase Stepper Motors



Product Name	CVD503 □□-K	CVD507 □□-K	CVD512 □□-K	CVD514 □□-K	CVD518 □□-K	CVD524 □□-K	CVD528B □-K	CVD538B □-K
Driving Method	Microstep Drive, Bipolar, Constant Current Drive Method							
Motor Driving Current (Factory Setting)	0.35 A/Phase	0.75 A/Phase	1.2 A/Phase	1.4 A/Phase	1.8 A/Phase	2.4 A/Phase	2.8 A/Phase	3.8 A/Phase
Power Supply Voltage	24 VDC±10%							
Input Current	A	0.6	1.4	1.7	1.8	2.8	3.0	4.8
Max. Input Pulse Frequency	Line driver output by programmable controller: 1 MHz (When the pulse duty is 50%) Open-collector output by programmable controller: 250 kHz (When the pulse duty is 50%) Negative Logic Pulse Input							
Operating Environment (In operation)	Ambient Temperature	0 to +50°C (+32 to +122°F) (Non-freezing)						
	Ambient Humidity	85% or less (Non-condensing)						
	Surrounding Atmosphere	No corrosive gas or dust. No water or oil.						

● For the right angle type with an installation plate, the box □ in the product name indicates the driver shape **B** (with installation plate), the box □ indicates the connector shape **R** (right angle).

Dimensions Unit = mm (in.)

Right Angle Type with Installation Plate

2D & 3D CAD

Product Name	Mass kg (oz)	2D CAD
CVD205BR-K	0.06 (2.12)	B1210
CVD206BR-K		
CVD215BR-K		
CVD223BR-K		
CVD223FBR-K		
CVD228BR-K		
CVD503BR-K		
CVD507BR-K		
CVD512BR-K		
CVD514BR-K		
CVD518BR-K		
CVD524BR-K		

● Included Items

Connector Housing:	51103-0200 (Molex)
	51103-0500 (Molex)
	51103-1200 (Molex)
Contact:	50351-8100 (Molex)

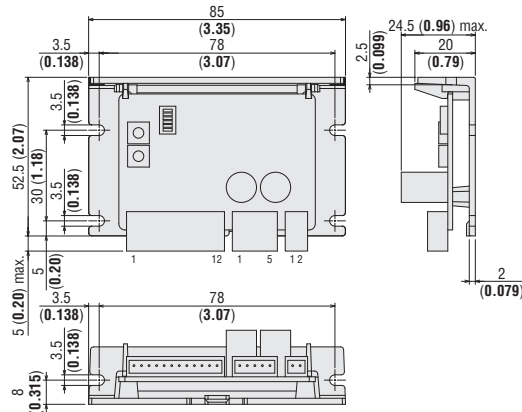

2D & 3D CAD

Product Name	Mass kg (oz)	2D CAD
CVD242BR-K	0.07 (2.47)	B1211
CVD245BR-K		
CVD528BR-K		
CVD538BR-K		

● Included Items

Connector Housing:	51067-0200 (Molex)
	51067-0500 (Molex)
	51103-1200 (Molex)
Contact:	50217-9101 (Molex)
	50351-8100 (Molex)

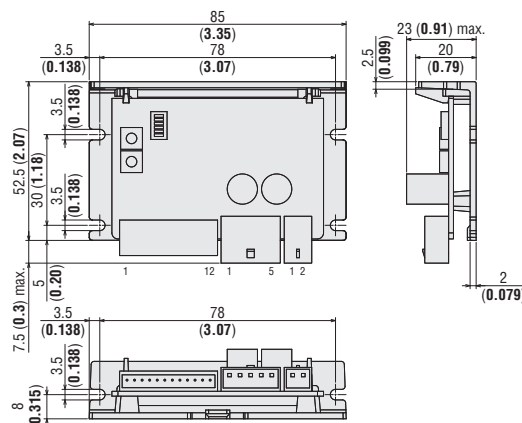

● Motor, power supply, and I/O signal cables are available as connection cable sets (sold separately). Refer to page 71 for details.

Without Installation Plate

2D & 3D CAD

Product Name	Mass kg (oz)	2D CAD
CVD205-K	0.02 (0.71)	B1128
CVD206-K		
CVD215-K		
CVD223-K		
CVD223F-K		
CVD228-K		
CVD503-K		
CVD507-K		
CVD512-K		
CVD514-K		
CVD518-K		
CVD524-K		

● Included Items

Connector Housing:	51103-0200 (Molex)
	51103-0500 (Molex)
	51103-1200 (Molex)
Contact:	50351-8100 (Molex)

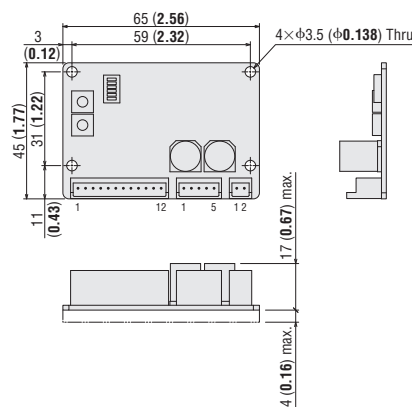

2-Phase
Motors
PKP

Features
Product
Line

Product
Number
Product Line

Standard
Type

High-
Resolution
Type

Flat Type

SH
Geared
Type

General
Specifications/
Inner Wiring
Diagram of Motor

5-Phase
Motors
PKP

Features
Product
Line

Product
Number
Product Line

Standard
Type

High-
Resolution
Type

TS
Geared
Type

General
Specifications/
Inner Wiring
Diagram of Motor

Driver for
2-Phase/
5-Phase Motors

Accessories

List of Applicable Motors

Bipolar Driver for 2-Phase Stepper Motors

Driver Product Name		Motor Drive Current	Applicable Motor
Right Angle Type with Installation Plate	Without Installation Plate		
CVD205BR-K	CVD205-K	0.5 A/Phase	PKP213D
CVD206BR-K	CVD206-K	0.6 A/Phase	PKP214D
CVD215BR-K	CVD215-K	1.5 A/Phase	PKP22□D15, PKP23□D15, PKP24□MD15, PKP262FD
CVD223BR-K	CVD223-K	2.3 A/Phase	PKP23□D23
CVD223FBR-K	CVD223F-K	2.3 A/Phase	PKP24□D08■2, PKP24□D15■2, PKP24□D23■2
CVD228BR-K	CVD228-K	2.8 A/Phase	PKP26□D14■2, PKP26□D28■2, PKP26□MD28
CVD242BR-K	—	4.2 A/Phase	PKP26□D42
CVD245BR-K	—	4.5 A/Phase	PKP29□D

- A number indicating the length of the motor case is entered where the box □ is located within the names of the applicable motors.
- Either **A** (single shaft) or **B** (double shaft) indicating the configuration is specified where the box ■ is located in the names of the applicable motors.
- The applicable motors are listed such that the available combinations with the driver are distinguishable.
Combinations with the encoder type or geared type are also available.
For details on the product name, please see the Oriental Motor website.

Driver for 5-Phase Stepper Motors

Driver Product Name		Motor Drive Current	Applicable Motor
Right Angle Type with Installation Plate	Without Installation Plate		
CVD503BR-K	CVD503-K	0.35 A/Phase	PK513, PK52□
CVD507BR-K	CVD507-K	0.75 A/Phase	PK52□H, PK54□
CVD512BR-K	CVD512-K	1.2 A/Phase	PKP52□
CVD514BR-K	CVD514-K	1.4 A/Phase	PK56□
CVD518BR-K	CVD518-K	1.8 A/Phase	PKP54□
CVD524BR-K	CVD524-K	2.4 A/Phase	PKP56□FN24, PKP56□FMN
CVD528BR-K	—	2.8 A/Phase	PKP56□N28
CVD538BR-K	—	3.8 A/Phase	PKP56□FN38

- A number indicating the length of the motor case is entered where the box □ is located within the names of the applicable motors.
- The applicable motors are listed such that the available combinations with the driver are distinguishable.
Combinations with the encoder type and geared type are also available.
For details on the product name, please see the Oriental Motor website.

Connection and Operation (Bipolar Driver for 2-phase stepper motor and Driver for 5-phase stepper motor)

Names and Functions of Driver Parts

1 Signal Monitor Display

LED Indicator

Indication	Color	Function	Lighting Condition
PWR/ALM	Green	Power supply indicator	When the power supply is input
	Red	Alarm indication	Blinks when protective function is activated

Alarm Details

Blink Count	Function	Operating Condition
2	Overheat protection	The temperature of a driver's substrate has reached 85°C (185°F)
3	Overvoltage protection	The power supply voltage has exceeded the permissible value Large inertial load came to a sudden stop Large load has been raised and/or lowered
5	Overcurrent protection	Activated when an excessive current flows through the motor's output circuit
9	EEPROM abnormality	The saved data for the driver has been damaged
Lighting	CPU abnormality	The driver's CPU has malfunctioned

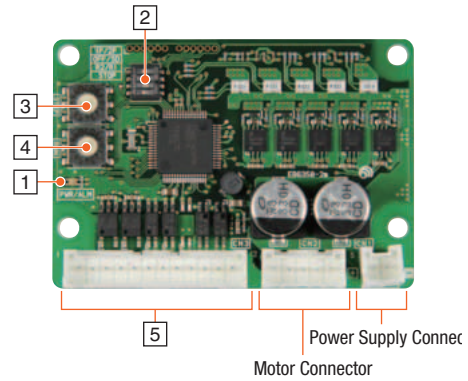

2 Function Switch

Indication	No.	Function
1P/2P	1	Switches the pulse input mode between 1-pulse input mode and 2-pulse input mode.
OFF/SD	2	Enables and disables the smooth drive function.
R2/R1	3	Sets the step angle in combination with the step angle setting switch
STOP	4	Switches the motor's standstill current between 25% and 50%.

3 Step Angle Setting Switch

Indication	Function
STEP	Sets the motor's step angle in combination with the R2/R1 switch.

Step Angle Setting Switch (STEP) Scale	R2/R1 Switch: When Turned ON (R1)		R2/R1 Switch: When Turned OFF (R2)	
	Resolution (P/R)	Step Angle	Resolution (P/R)	Step Angle
0	500	0.72°	200	1.8°
1	1000	0.36°	400	0.9°
2	1250	0.288°	800	0.45°
3	2000	0.18°	1000	0.36°
4	2500	0.144°	1600	0.225°
5	4000	0.09°	2000	0.18°
6	5000	0.072°	3200	0.1125°
7	10000	0.036°	5000	0.072°
8	12500	0.0288°	6400	0.05625°
9	20000	0.018°	10000	0.036°
A	25000	0.0144°	12800	0.028125°
B	40000	0.009°	20000	0.018°
C	50000	0.0072°	25000	0.0144°
D	62500	0.00576°	25600	0.0140625°
E	100000	0.0036°	50000	0.0072°
F	125000	0.00288°	51200	0.00703125°

● Compared to standard types, high-resolution types have twice the resolution and half of the step angle.

Example: When the R2/R1 switch is ON (R1) and the STEP switch is "0"

Resolution of high-resolution types: $500 \times 2 = 1000$

Step angle of high-resolution types: $0.72^\circ / 2 = 0.36^\circ$

4 Operation Current Setting Switch

Indication	Function
RUN	Sets the motor's operating current.

5 I/O Signal Connector

Indication	Pin No.	I/O	Signal Name	Function
CN3	1	Input	CW+ (PLS+)	Motor will rotate in the CW direction. (Operation command pulse signal when 1-pulse input mode is used)
	2		CW- (PLS-)	
	3		CCW+ (DIR.+)	Motor will rotate in the CCW direction. (Rotation direction signal when 1-pulse input mode is used)
	4		CCW- (DIR.-)	
	5		AWO+	Switches the motor into its non-excitation state.
	6		AWO-	
	7	Output	CS+	Switches the step angle.
	8		CS-	
	9	ALM+	Output the alarm status for the driver (Normally closed contact)	
	10	ALM-		
	11	TIM+	Motor's excitation state is output at step "0."	
	12	TIM-		

2-Phase
Motors
PKP

Features
Product
Line

Product
Number
Product Line

Standard
Type

High-
Resolution
Type

Flat Type

SH
Geared
Type

General
Specifications/
Inner Wiring
Diagram of Motor

5-Phase
Motors
PKP

Features
Product
Line

Product
Number
Product Line

Standard
Type

High-
Resolution
Type

TS
Geared
Type

General
Specifications/
Inner Wiring
Diagram of Motor

Driver for
2-Phase/
5-Phase Motors

Accessories

Connection Diagrams

- When the I/O signal voltage is 5 VDC
- ◇ When the pulse input is the line driver

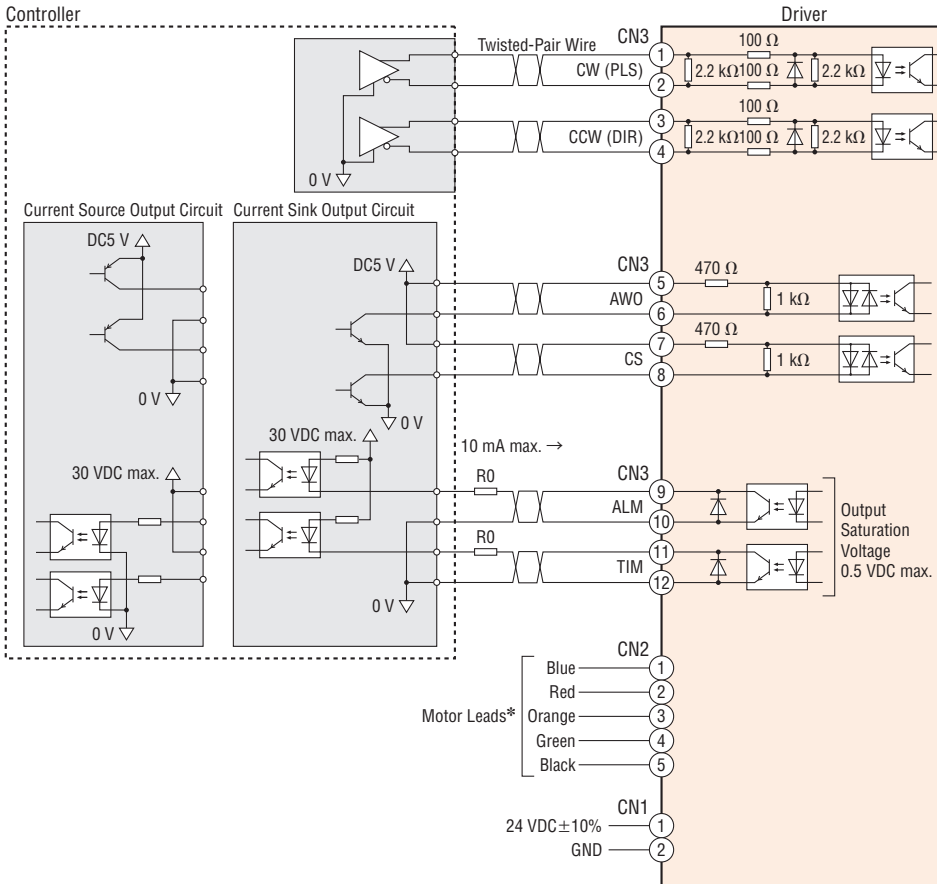

*The connector pinout differs depending on the motor. Please check the following connection table for details.

◇ 2-Phase CVD Driver Connection Table

- Motor: 2-Phase **PKP/PK**Series Bipolar 4 Lead Wires
- Driver: Bipolar Driver for 2-Phase Stepper Motors

Driver CN2 Pin No.	Model A		Model B		Model C
	Pin No.	Color	Pin No.	Color	Color
1	4	Blue	1	Blue	Blue
2	5	Red	3	Red	Red
3	-	-	-	-	-
4	2	Green	6	Green	Green
5	1	Black	4	Black	Black

● Colors in the table indicate the color of the lead wire of the separately sold connection cable.

Note

- Model A and model B motors have different pinouts. The motor will not rotate normally if the connection is wrong.

◇ 5-Phase CVD Driver Connection Table

- Motor: 5-Phase **PKP/PK** Series
- Driver: Driver for 5-Phase Stepper Motors

Driver CN2 Pin No.	Model A		Model B		Model C
	Pin No.	Color	Pin No.	Color	Color
1	5	Blue	1	Blue	Blue
2	4	Red	2	Red	Red
3	3	Orange	3	Orange	Orange
4	2	Green	4	Green	Green
5	1	Black	5	Black	Black

● Colors in the table indicate the color of the lead wire of the separately sold connection cable.

◇ When the pulse input is open collector

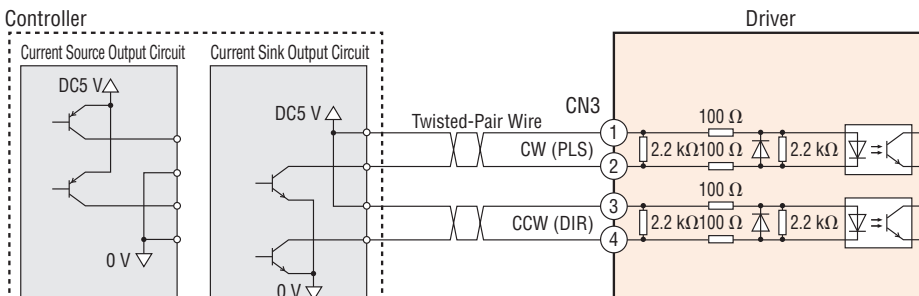

● When the I/O signal voltage is 24 VDC

◇ When the pulse input is open collector

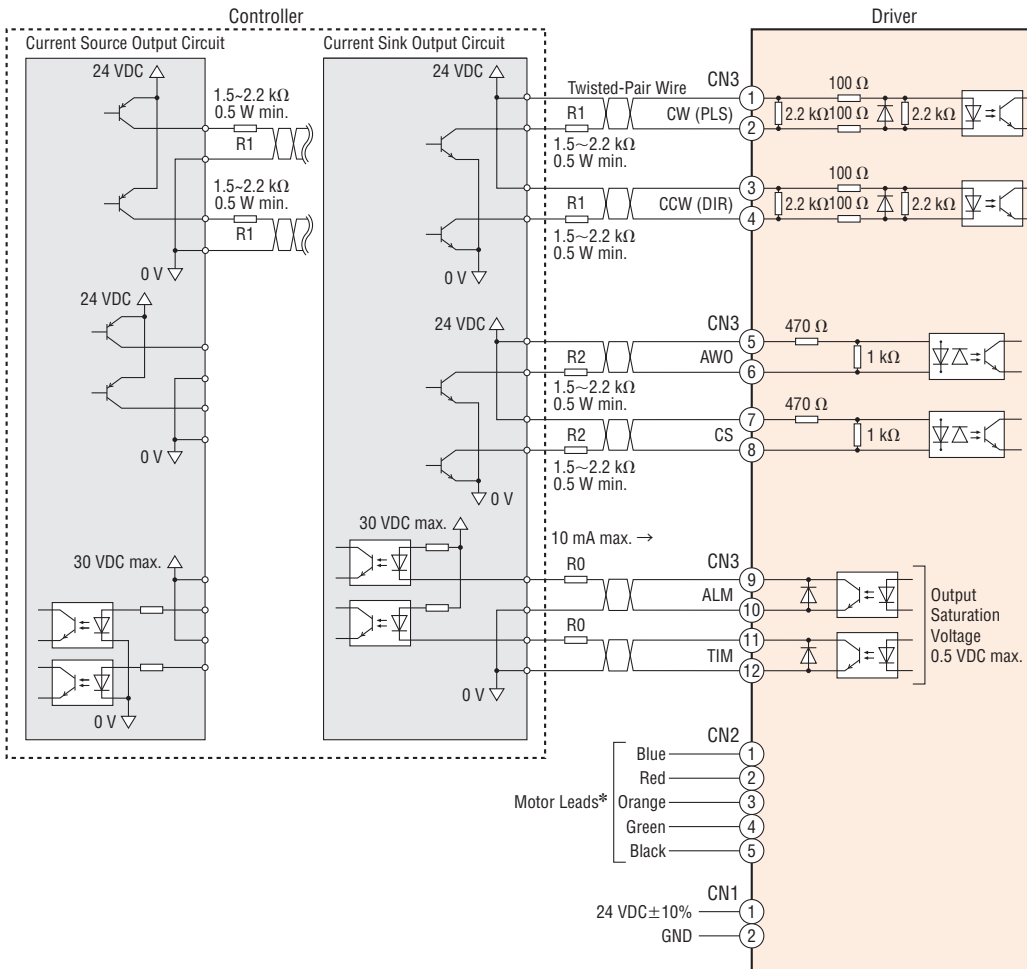

*The connector pinout differs depending on the motor. Please check the connection table on page 113 for details.

[Notes on Wiring]

◇ I/O Signal Connection

● Input Signals

- CW input and CCW input are 5 VDC. If the voltage exceeds 5 VDC, connect an external resistor R1 so that the input current becomes 7~20 mA.
Example) When connecting 24 VDC, R1: 1.5~2.2 kΩ, 0.5 W min.
- AWO input and CS input are 5 VDC. If the voltage exceeds 5 VDC, connect an external resistor R2 so that the input current becomes 5~15 mA.
Example) When connecting 24 VDC, R2: 1.5~2.2 kΩ, 0.5 W min.

● Output Signals

- Use output signals at 30 VDC 10 mA max. When the current value exceeds 10 mA, connect an external resistor R0.
- Use twisted-pair cables of AWG24~22 (0.2~0.3 mm²).
- Note that as the length of the pulse line increases, the max. transmission frequency decreases, and keep the wiring length as short as possible (2 m (6.6 ft.) max.).
- Provide a distance of 100 mm (3.94 in.) min. between the signal lines and power lines (such as power supply lines and motor lines).

◇ Power Supply Connection

- Use a wire of AWG22 (0.3 mm²). For **CVD242**, **CVD245**, **CVD528** and **CVD538**, use a wire of AWG20~18 (0.5~0.8 mm²).
- Incorrect polarities of the DC power-supply input will damage the driver. Make sure that the polarity is correct before turning the power on.

◇ Motor Cable Extension

- Use a wire of AWG22 (0.3 mm²) min. For **CVD242**, **CVD245**, **CVD528** and **CVD538**, use a wire of AWG20 (0.5 mm²) min.
Up to three cables can be used to connect the motor and driver. (Excluding **CVD242**, **CVD245**, **CVD528** and **CVD538**)
- The maximum extension length is 10 m (32.8 ft.).

◇ General

- A separate hand crimp tool is required to crimp the connector and lead wires included with the driver. Connection cables which are available as accessories (sold separately) have already had their lead wires crimped.
- If a specific wiring and layout causes the motor cable or power supply cable to generate a noise problem, shield the cable or use ferrite cores.

2-Phase
Motors
PKP

Features
Product
Line

Product
Number
Product Line

Standard
Type

High-
Resolution
Type

Flat Type

SH
Geared
Type

General
Specifications/
Inner Wiring
Diagram of Motor

5-Phase
Motors
PKP

Features
Product
Line

Product
Number
Product Line

Standard
Type

High-
Resolution
Type

TS
Geared
Type

General
Specifications/
Inner Wiring
Diagram of Motor

Driver for
2-Phase/
5-Phase Motors

Accessories

Cables

2-Phase
Bipolar
5-Phase

Cables

Cable System Configuration Example

Encoder Connection Cables

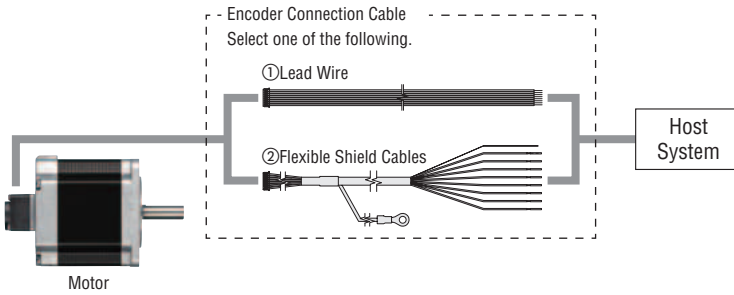

Driver Connection Cable

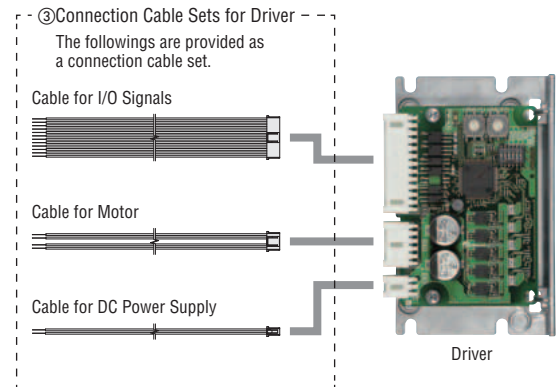

Note

- Up to three cables can be used to connect the motor and driver. Contact your local Oriental Motor sales office.
- The maximum extension lengths between the motor and driver is 10 m (32.8 ft.).

① Encoder Connection Cable - Lead Wire

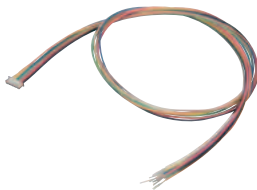

This is an encoder connection cable with a motor-side connector. For cable dimensions, please refer to the specification and dimensions page for each motor.

Product Line

Product Name	Applicable Motor	Encoder Type	Length L	Conductor AWG	List Price
LCE05A-006	2-Phase/5-Phase Motor with Encoder	Voltage	0.6 m (2 ft.)	26 (0.13 mm ²)	\$11.00
LCE08A-006		Line Driver			

② Encoder Flexible Shield Connection Cable

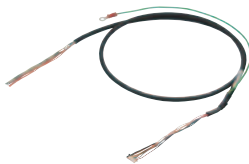

These are flexible shield cables with crimped connectors that are used for connecting encoders and controllers. There is a protruding shield ground wire for easy grounding.

Product Line

Product Name	Applicable Motor	Length L m (ft.)	Conductor AWG	List Price
CC010E1R	2-Phase/5-Phase Motor with Encoder	1 (3.3)	26 (0.13 mm ²)	\$50.00
CC020E1R		2 (6.6)		\$79.00

- For dimensions, please see the Oriental Motor website.

③ Connection Cable Sets for Driver

Motor, I/O signal, and DC power supply connection cables that connect to the driver are available as a set. The connector is on the driver end.

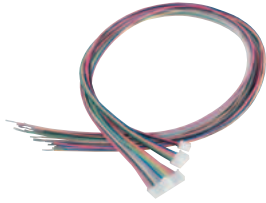

● Product Line

Product Name	Applicable Drivers	Connector	Connector Product Name	Length L1	Length L2	Conductor AWG	List Price
LCS04SD5	CVD503, CVD507 CVD512, CVD514 CVD518, CVD524	For Motor	51103-0500	0.6 m (2 ft.)	10 mm (0.4 in)	22 (0.3 mm ²)	\$25.00
		For Power Supply	51103-0200				
		For I/O Signal	51103-1200				
LCS05SD5	CVD528, CVD538	For Motor	51067-0500				
		For Power Supply	51067-0200				
		For I/O Signal	51103-1200				
LCS01CVK2	CVD205, CVD206 CVD215, CVD223 CVD228	For Motor	51103-0500				
		For Power Supply	51103-0200				
		For I/O Signal	51103-1200				
LCS02CVK2	CVD242, CVD245	For Motor	51067-0500				
		For Power Supply	51067-0200				
		For I/O Signal	51103-1200				

● The applicable driver names are listed such that the product names are distinguishable.

● Dimensions

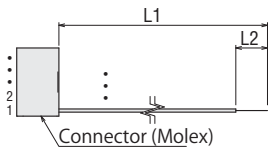

● Connector Arrangement

◇ For Motor

● LCS0□SD5

Pin No.	Wire Color
1	Blue
2	Red
3	Orange
4	Green
5	Black

● LCS0□CVK2

Pin No.	Wire Color
1	Blue
2	Red
3	—
4	Green
5	Black

● LCS01CMK2

Pin No.	Wire Color
1	Blue
2	White
3	Red
4	Black
5	Yellow
6	Green

◇ For Power Supply

● Common for all Cables

Pin No.	Wire Color
1	Red
2	Black

◇ For I/O Signal

● Common for all Cables

Pin No.	Wire Color
1	Brown
2	Red
3	Orange
4	Yellow
5	Green
6	Blue
7	Purple
8	Gray
9	White
10	Black
11	Brown
12	Red

2-Phase
Motors
PKP

Features
Product
Line

Product
Number
Product Line

Standard
Type

High-
Resolution
Type

Flat Type

SH
Geared
Type

General
Specifications/
Inner Wiring
Diagram of Motor

5-Phase
Motors
PKP

Features
Product
Line

Product
Number
Product Line

Standard
Type

High-
Resolution
Type

TS
Geared
Type

General
Specifications/
Inner Wiring
Diagram of Motor

Driver for
2-Phase/
5-Phase Motors

Accessories

Accessories

For more information, please check our website or contact our customer service center. www.orientalmotor.com

2-Phase
Bipolar
5-Phase

Cables

Flexible Coupling RoHS



Coupling Selection Table

Type	Applicable Product		Coupling Type	Motor Shaft Diameter mm (in.)	Driven Shaft Diameter mm (in.)									
	Motor Frame Size	Applicable Motor			04	05	06	F04	08	10	12			
					φ4 (φ0.1575)	φ5 (φ0.1969)	φ6 (φ0.2362)	φ6.35 (φ0.2500)	φ8 (φ0.3150)	φ10 (φ0.3937)	φ12 (φ0.4724)			
High-Torque Type	20 mm (0.79 in.)	PKP213	MCS14	04	φ4 (φ0.1575)	●	●	●						
	28 mm (1.10 in.)	PKP223	MCS14	05	φ5 (φ0.1969)	●	●	●						
		PKP523				●	●	●						
		PKP225 PKP525				●	●	●						
	35 mm (1.38 in.)	PKP233 PKP235	MCS14	05	φ5 (φ0.1969)	●	●	●						
	42 mm (1.65 in.)	PKP243 PKP244 PKP544				MCS14	05	φ5 (φ0.1969)	●	●	●			
		PKP246 PKP546	MCS20	05	φ5 (φ0.1969)				●	●	●	●	●	
		PKP264* PKP564							MCS20	F04	φ6.35 (φ0.2500)	●	●	●
56.4 mm (2.22 in.)	PKP266* PKP268* PKP566 PKP568	MCS30	F04	φ6.35 (φ0.2500)	●	●	●	●				●		
	60 mm (2.36 in.)				PKP564 PKP566	MCS20	08	φ8 (φ0.3150)	●	●	●	●	●	
					PKP569				MCS30	08	φ8 (φ0.3150)	●	●	●

- The applicable motor products are listed such that the coupling can be determined.
- These couplings can also be used with a motor with an encoder.
- *For 8 mm (0.3150 in.) front motor shaft, use **MCS2008**.

Motor Mounting Brackets

The installation bracket base is built with holes large enough to allow for adjustments of belt tension after a motor is installed.

Product Line

◇ For Standard Type, High-Resolution Type

Material: Aluminum Alloy (SPCC)*

Product Name	List Price	Motor Frame Size	Applicable Product
PFB28A	\$26.00	28 mm (1.10 in.)	PKP22 □, PKP52 □
PAFOP PALOP	\$13.00	42 mm (1.65 in.)	PKP24 □ PKP54 □
PAL2P-2			\$17.00
PAL2P-5	60 mm (2.36 in.)	PKP56 □ F	
PAL4P-2	\$19.00	85 mm (3.35 in.)	PKP29 □

*Brackets contain the specifications for **PFB28A**.

- These installation brackets can be perfectly fitted to the pilot of the stepper motors. (Excluding **PALOP**)

◇ For **SH** Geared Type

Material: Aluminum Alloy (SPCC)*

Product Name	List Price	Motor Frame Size	Applicable Product
PFB28A	\$26.00	28 mm (1.10 in.)	PKP223
SOL0A	\$23.00	42 mm (1.65 in.)	PKP243
SOL2A	\$27.00	60 mm (2.36 in.)	PKP264

*Brackets contain the specifications for **PFB28A**.

◇ For **TS** Geared Type

Material: Aluminum Alloy

Product Name	List Price	Motor Frame Size	Applicable Product
SOL0B	\$23.00	42 mm (1.65 in.)	PKP54 □
SOL2M4	\$27.00	60 mm (2.36 in.)	PKP56 □



Mounting Brackets for Circuit Products

These are brackets for installation on a DIN rail.

<MADP07 usage example>

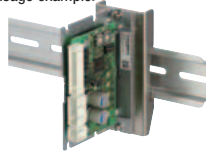

Product Line

Material: SPCC

Product Name	List Price	Applicable Drivers	Surface Treatment
MADP07	\$11.00	CVD□□□BR-K CVD□□□B-K	Electroless nickel plating

Circuit Product Cover

This is a protection cover to prevent contact with the circuit board.
Available for the right angle type driver with an installation plate.

<Application Example>



Product Line

Material: Resin

Product Name	List Price	Applicable Drivers
PADC-CVD	\$14.00	CVD□□□BR-K

Clean Dampers

Mechanical dampers suppress stepper motor vibration and improve high-speed performance.
An inertia body and silicon gel are hermetically sealed in a plastic case.

Product Line



● This clean damper is an accessory for double shaft types.

Product Name	Inertia kg·m ² (oz·in ²)	Mass g (oz)	Motor Frame Size	Applicable Product	List Price
D4CL-5.0F	34×10 ⁻⁷ (7.6)	24 (0.85)	28 mm (1.10 in.) 42 mm (1.65 in.)	PKP223, PKP225, PKP523, PKP525 PKP233, PKP235 PKP243, PKP244, PKP543, PKP544 PKP245, PKP246, PKP545, PKP546	\$42.00
D6CL-6.3F	140×10 ⁻⁷ (0.77)	62 (2.2)	50 mm (1.97 in.)	PK256, PK258	\$42.00
D6CL-8.0F	140×10 ⁻⁷ (0.77)	61 (2.2)	56.4 mm (2.22 in.)* 60 mm (2.36 in.)	PKP264, PKP266, PKP268 PK264, PK266, PKP564, PKP566 PK267, PK269, PKP568, PKP569	\$42.00
D9CL-14F	870×10 ⁻⁷ (4.8)	105 (3.7)	85 mm (2.35 in.)	PKP296, PKP299, PKP2913	\$53.00

Operating Temperature Range: -20~+80°C (-4~+176°F)

*56.4 mm (2.22 in.) **PKP26_/PKP56_** encoder and electromechanical brake motors, have 8 mm shaft. Use **D6CL-8.0F**.

2-Phase
Motors
PKP

Features
Product
Line

Product
Number
Product Line

Standard
Type

High-
Resolution
Type

Flat Type

SH
Geared
Type

General
Specifications/
Inner Wiring
Diagram of Motor

5-Phase
Motors
PKP

Features
Product
Line

Product
Number
Product Line

Standard
Type

High-
Resolution
Type

TS
Geared
Type

General
Specifications/
Inner Wiring
Diagram of Motor

Driver for
2-Phase/
5-Phase Motors

Accessories

Controller

Universal Controller SCX11

The **SCX11** Universal Controller is a highly functional and sophisticated controller, equipped with program editing and execution functions. The **SCX11** is also able to control the motor via various serial ports such as USB, RS-232C and **CANopen**. Use the **SCX11** to support Oriental Motor's Pulse Input Type drivers.



Features

- 100 Sequence Programs can be Stored
- Stored Program with GUI
- USB Connection to PC
- Various Interfaces for Operation
- External Encoder Input
- Stand Alone Operation Using Sensors and Switches

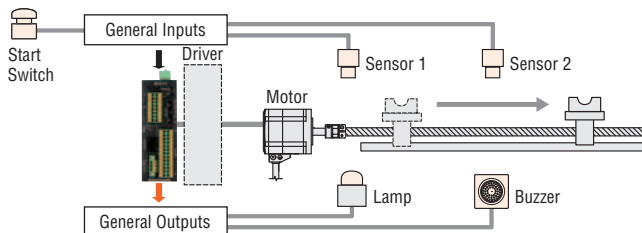

Product Line

Product Name	List Price
SCX11	\$349.00

Various Interfaces for Operation

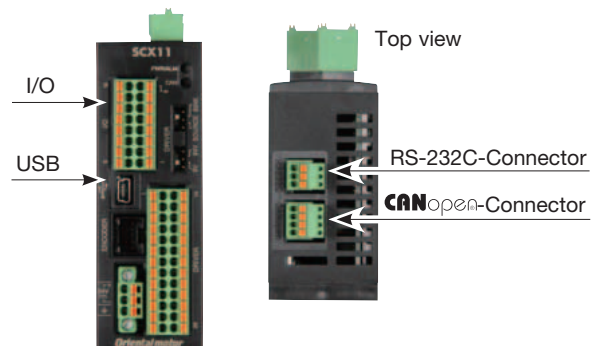

- Direct Command Operation via CANopen
- Operations Using a PC or PLC

Specifications are subject to change without notice. This catalog was published in August, 2018.

ORIENTAL MOTOR U.S.A. CORP.

Western Sales and Customer Service Center

Tel: (310) 715-3301 Fax: (310) 225-2594

Los Angeles

Tel: (310) 715-3301

San Jose

Tel: (408) 392-9735

Seattle

Tel: (425) 214-7559

Midwest Sales and Customer Service Center

Tel: (847) 871-5900 Fax: (847) 472-2623

Chicago

Tel: (847) 871-5900

Detroit

Tel: (734) 808-0003

Dallas

Tel: (214) 432-3386

Toronto

Tel: (905) 502-5333

Eastern Sales and Customer Service Center

Tel: (781) 848-2426 Fax: (781) 848-2617

Boston

Tel: (781) 848-2426

Charlotte

Tel: (704) 766-1335

New York

Tel: (973) 359-1100

Philadelphia

Tel: (610) 605-3103

Tampa

Tel: (813) 402-4439

Technical Support

Tel: (800) 468-3982 / 8:30 A.M. to 5:00 P.M., P.S.T. (M-F)
7:30 A.M. to 5:00 P.M., C.S.T. (M-F)

E-mail: techsupport@orientalmotor.com

Obtain Specifications, Online Training
and Purchase Products at:
www.orientalmotor.com

Copyright ©2018 ORIENTAL MOTOR U.S.A. CORP.

This printed material uses ECF (Elemental Chlorine Free) paper and vegetable oil based inks. This combination is environmentally friendly.