

Cooling Fans

# Thermostats

## Thermostats

**RoHS** RoHS-Compliant

## Thermostats

# AM1-WA1/AM1-XA1

● Additional Information ●  
 Technical Reference → Page F-1  
 Safety Standards → Page G-2

Thermostats **AM1-WA1** and **AM1-XA1** automatically performs ON/OFF fan control in accordance with the temperature fluctuation inside the equipment. It helps improve the equipment's "environmental" performance relative to energy savings, noise reduction, etc.



● List of safety standard approved products (Model, Standards, File No., Certification Body)  
 → Page G-11



## Features

### ● Effective for Energy-Saving

Thermostat makes it possible for fans to operate only when cooling is necessary.

This product makes for energy-saving by automatically stopping fans for example, at night, when the amount of heat generation declines following the load rate's decline in equipment, or in winter, when the ambient temperature drops and forced cooling is not necessary.

### ● Noise Reduction

The fans are operated only when cooling is required, thereby keeping fan noise to a minimum.

### ● **RoHS** RoHS-Compliant

Thermostats **AM1-WA1** and **AM1-XA1** conform to the RoHS Directive that prohibits the use of six chemical substances including lead and cadmium.

● Details of RoHS Directive → Page G-38

## Product Line

Type	Model
Fahrenheit	<b>AM1-WA1</b>
Centigrade	<b>AM1-XA1</b>

The following items are included in each product.  
 Thermostat, Operating Manual

### ● Easy Setting

Range of operating temperature: 0 to +60°C (+32 to +140°F)

In addition, the setting is very easy; all you have to do is set the front dial to the desired temperature.

### ● Elimination of Power Supply

There is no need to provide a separate power supply for the thermostat.

### ● Conforms to DIN Rail, Compact Design

W33 mm×H60 mm×D35 mm (W1.30 in.×H2.36 in.×D1.38 in.)

Thermo bimetal built-in thermostat

## Specifications **RoHS**



Item	Specifications
Type of Sensor	Thermo bimetal, Contact: Normal open
Operating Temperature Range	[0~60°C (+32~140°F)]±10°C (18°F)
Differential	[Operating temperature -7°C (12.6°F)]±4°C (7.2°F)
Applicable Lead Wire Size	AWG18~14 (0.75~2.5 mm <sup>2</sup> )

## General Specifications

Item	Specifications	
Dielectric Strength	Between the frame and the terminal	Sufficient to withstand 3.75 kVAC for one minute under normal ambient temperature and humidity.
	Between the terminals	Sufficient to withstand 0.5 kVAC for one minute under normal ambient temperature and humidity.
Ambient Temperature	-20~+80°C (-4~+176°F)	
Ambient Humidity	90 % or less (non-condensing)	
Color	Light gray	

### Notes:

- If foreign objects get into the sensor, the thermostat may not work properly. The use of a filter at the intake is recommended so foreign objects will not enter the area where the sensor is located.
- Be sure to use the applicable products.
- Install the product on an IEC (DIN) rail. Make sure that no force (tension, stress, etc.) is applied to the terminal section.

## Applicable Products

Input	Series	Model	Number of Connectable Fans
Single-Phase AC-Input	<b>MU Series</b>	All models	9
	<b>FM Series</b>	All models	9
	<b>MRS Series</b>	<b>MRS25</b>	1
		<b>MRS20</b>	2
		<b>MRS18</b>	2
		<b>MRS16</b>	5
	<b>MB Series</b>	<b>MB1665*</b> <b>MB1255</b>	1
		<b>MB1040</b>	4
		<b>MB840</b>	7
		<b>MB630, MB520</b>	9
<b>MF Series</b>		<b>MF930, MF915</b>	5

\* For **MB1665** type, thermostats can be used only for single-phase 100 VAC and 200 VAC products.

**Note:**

● Impression of voltage exceeding the rated voltage may shorten the service life of the product.

## Dimensions Unit = mm (in.)

Mass: 45 g (1.6 oz.)

**AM1-WA1**: DXF E108

**AM1-XA1**: DXF E108

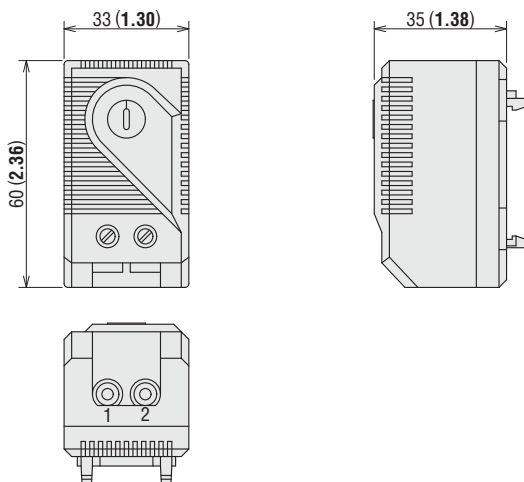

## Effective Use of the Thermostat

Using a fan with a thermostat provides automatic on/off control of the fan and air flow switching.

### ● ON/OFF Control of a Single Fan

When the temperature within the enclosure rises to a specified level (preset temperature), the thermostat activates the fan automatically. Once the enclosure interior is sufficiently cooled, it causes the fan to stop. This is a great way to save energy and reduce noise.

### ◇ Application Example

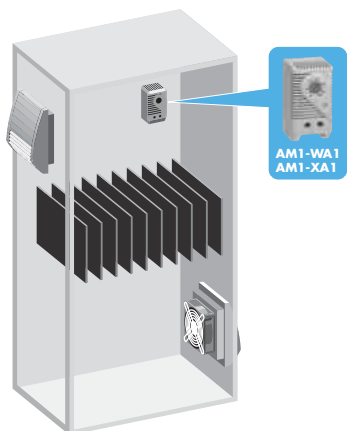

### ◇ Connection Example

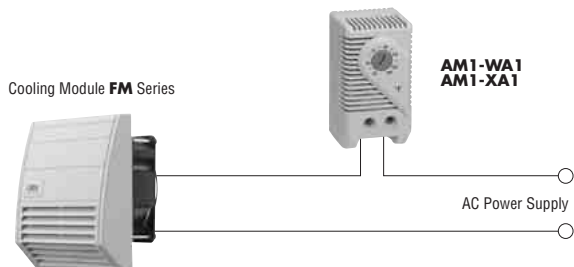

### ● ON/OFF Control of Multiple Fans

Multiple fans can be effectively controlled in cases where more than one fan is needed to produce the required air flow or static pressure. For example, a thermostat can control a maximum of nine **MU1238** type fans. (A six-fan configuration is shown.)

### ◇ Application Example

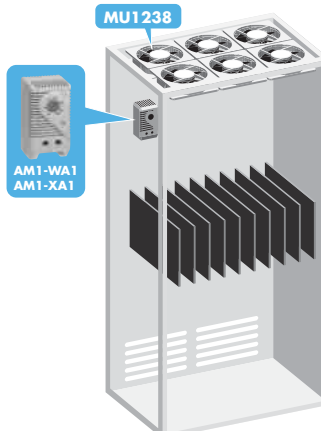

● When using 6 fans (**MU1238**)

Thermostat	Number of Fans	Input W	Noise Level dB (A)
ON	6	84	51
OFF	-	0	0

### ◇ Connection Example

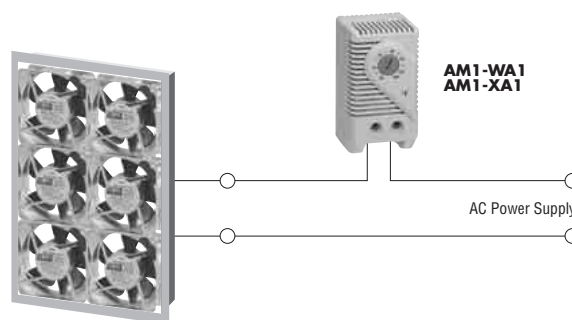

## ● Control the Number of Constant Speed Fans in Operation

The use of two thermostats enables switching the number of fans being operated to change the air flow in accordance with temperature.

This helps save energy and reduce noise.

- This control method is effective with densely mounted equipment.

### ◇ Application Example

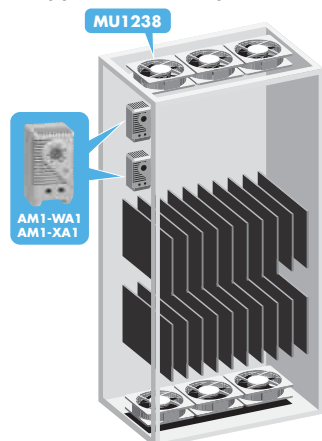

#### ● MU1238 Type Multiple Switching Control

Temperature	Number of Fans	Input W	Noise Level dB (A)
High 40°C (104°F)	6	84	51
Low 25°C (77°F)	3	42	48

### ◇ Connection Example

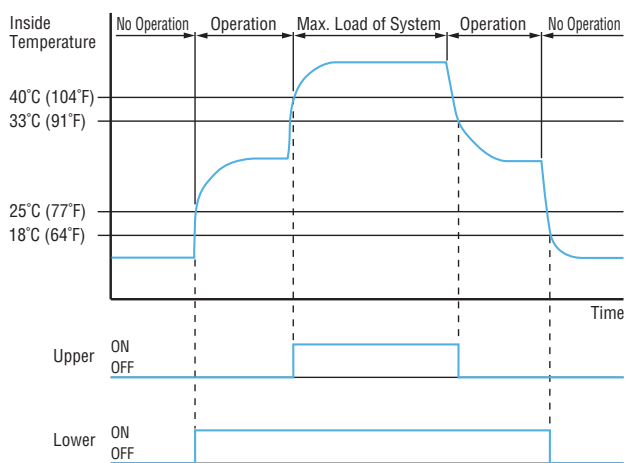
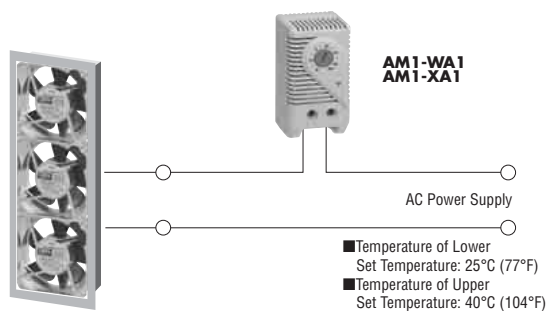

#### Notes:

- Connect the lead wire to the thermostat as shown in the diagrams, regardless of how many fans are used or of the fan's wire diameter.
- When connecting multiple fans, always use a terminal block. Don't connect the lead wires of multiple fans directly to the thermostat.
- When using variable flow fan, don't connect the lead wires for connecting variable resistor directly to the thermostat.

#### ● Recommended Crimp Terminal

Crimp terminal is not included. When crimp terminal is required for connecting, use the crimp terminal shown below.

Phoenix Contact Inc: AI 1-8  
Applicable lead wire size: AWG18

