

**(RoHS) RoHS-Compliant**

## Inverter

# FE100/FE200

A new inverter that enables speed control to be set easily with a built-in digital display.

The inverter parameters have been set exclusively for Oriental Motor's three-phase motors, enabling the motor performance to be maximized by simply setting the output power.



### Digital Display

The set speed is displayed digitally in frequency (Hz) or speed (r/min). The set speed of the gearhead output shaft can also be displayed.

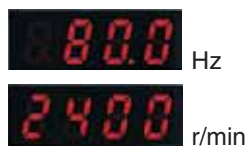

### Easy Operation

The speed can be set easily with the potentiometer on the inverter front panel.



### Easy Setting

Easy setting by simply setting a switch in accordance with the motor output power. No troublesome adjustment is required.  
FE100: For output power of 6 W to 90 W  
FE200: For output power of 25 W to 200 W



Motor Output Power Select Switch (photograph: FE100)  
Remove the front panel to access the switch.

### ● Maximized Motor Performance

As the inverter parameters have been set for motors in advance, the motor performance can be maximized at both low and high speeds.  
(Speed setting range: 200 to 2400 r/min)  
Continuous operation is also possible within the permissible torque.

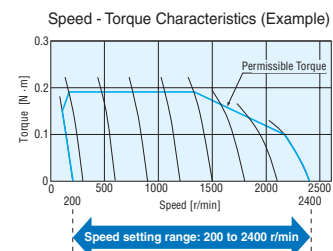

### Applicable Motors (Sold Separately)



Global Standard  
World K Series  
1/125 - 1/8HP



Watertight,  
Dust-Resistant Motors  
FPW Series  
1/30 - 1/8HP



High-Output Power  
BH Series  
1/4HP

## Product Number Code

**FE**      **100**      **A**

■ Maximum Output Power of Applicable Motor

**100:** 100W (1/8HP)

**200:** 200W (1/4HP)

■ Power Supply Voltage

**A:** Single-Phase 100-120VAC

**C:** Single-Phase 200-240VAC

**S:** Three-Phase 200-240VAC

## Product Line RoHS

Maximum Output Power of Applicable Motor	Power Supply Voltage	Model
100W (1/8HP)	Single - Phase 100 - 120VAC	<b>FE100A</b>
	Single - Phase 200 - 240VAC	<b>FE100C</b>
	Three - Phase 200 - 240VAC	<b>FE100S</b>
200W (1/4HP)	Single - Phase 100 - 120VAC	<b>FE200A</b>
	Single - Phase 200 - 240VAC	<b>FE200C</b>
	Three - Phase 200 - 240VAC	<b>FE200S</b>

## Specifications of Motor and Inverter Combinations

**ZP** : Impedance protected.

**TP** : Contains a built-in thermal protector.

- The set speed displayed on the product is calculated based on the following formula:

$$\text{Set frequency [Hz]} \times 30 = \text{Set speed [r/min]}$$

The actual speed varies depending on the load condition. Check the speed – torque characteristics.

	Motor Model		Applicable Inverter	Power Source			Max. Output Power W (HP)	Permissible Torque		Variable Speed Range Hz (r/min)		
	Pinion Shaft Type or Geared Type (Round Shaft Type)			Voltage VAC	Frequency Hz	Current A		Set Frequency Hz (Set speed r/min)	Torque			
	Lead Wire Type	Terminal Box Type							N·m		oz·in	
WK Series <sup>*1</sup>	<b>ZP</b>	2IK6GN-SW2 (2IK6A-SW2)	-	FE100A	Single - Phase 100 - 120±10%	50/60 ±10%	0.68	6 (1/125)	6.6 (200)	0.042 5.9	6.6-80 (200-2400)	
				FE100C	Single - Phase 200 - 240±10%		0.42					0.049 6.9
				FE100S	Three - Phase 200 - 240±10%		0.23					
	<b>TP</b>	4IK25GN-SW2 (4IK25A-SW2)	4IK25GN-SW2T (4IK25A-SW2T)	FE100A	Single - Phase 100 - 120±10%		1.3	25 (1/30)	6.6(200)	0.15 21		
				FE100C	Single - Phase 200 - 240±10%		0.77					0.19 26
				FE100S	Three - Phase 200 - 240±10%		0.43					
	<b>TP</b>	5IK40GN-SW2 (5IK40A-SW2)	5IK40GN-SW2T (5IK40A-SW2T)	FE100A	Single - Phase 100 - 120±10%		1.7	40 (1/19)	6.6~50(200~1500)	0.30 42		
				FE100C	Single - Phase 200 - 240±10%		0.96					0.16 22
				FE100S	Three - Phase 200 - 240±10%		0.53					
	<b>TP</b>	5IK60GE-SW2 (5IK60A-SW2)	5IK60GE-SW2T (5IK60A-SW2T)	FE100A	Single - Phase 100 - 120±10%		2.3	60 (1/12)	6.6(200)	0.31 44		
				FE100C	Single - Phase 200 - 240±10%		1.3					0.45 63
				FE100S	Three - Phase 200 - 240±10%		0.72					
<b>TP</b>	5IK90GE-SW2 (5IK90A-SW2)	5IK90GE-SW2T (5IK90A-SW2T)	FE100A	Single - Phase 100 - 120±10%	2.7	90 (1/8)	6.6(200)	0.45 63				
			FE100C	Single - Phase 200 - 240±10%	1.6				0.50 71			
			FE100S	Three - Phase 200 - 240±10%	0.85					0.36 51		
FPW Series <sup>*2</sup>	<b>TP</b>	FPW425S2-□	-	FE100A	Single - Phase 100 - 120±10%	50/60 ±10%	1.3	25 (1/30)	6.6(200)		0.15 21	6.6-80 (200-2400)
				FE100C	Single - Phase 200 - 240±10%		0.77			0.19 26		
				FE100S	Three - Phase 200 - 240±10%		0.43					
	<b>TP</b>	FPW540S2-□	-	FE100A	Single - Phase 100 - 120±10%		1.7	40 (1/19)	6.6~50(200~1500)	0.30 42		
				FE100C	Single - Phase 200 - 240±10%		0.96				0.16 22	
				FE100S	Three - Phase 200 - 240±10%		0.53					
	<b>TP</b>	FPW560S2-□	-	FE100A	Single - Phase 100 - 120±10%		2.3	60 (1/12)	6.6(200)	0.38 53		
				FE100C	Single - Phase 200 - 240±10%		1.3				0.45 63	
				FE100S	Three - Phase 200 - 240±10%		0.71					
	<b>TP</b>	FPW690S2-□	-	FE100A	Single - Phase 100 - 120±10%		3.0	90 (1/8)	6.6~50(200~1500)	0.68 96		
				FE100C	Single - Phase 200 - 240±10%		1.8				0.36 51	
				FE100S	Three - Phase 200 - 240±10%		0.92					
BH Series <sup>*3</sup>	-	-	<b>TP</b>	BHI62ST-□RH	FE200A	Single - Phase 100 - 120±10%	4.9	200 (1/4)	6.6(200)	1.29 183		
				BHI62ST-□RA	FE200C	Single - Phase 200 - 240±10%	2.8					1.49 210
				BHI62ST-□	FE200S	Three - Phase 200 - 240±10%	1.5					
				(BHI62ST-A)								

\*1 For pinion shaft type motor, gearhead is sold separately.

\*2 Geared Type only. Enter the gear ratio in the box (□) within the model name.

\*3 Enter the gear ratio in the box (□) within the model name.

## Common Specifications

### Inverter (RoHS)



Model		FE100A	FE100C	FE100S	FE200A	FE200C	FE200S
Maximum Output Power of Applicable Motor		W(HP)		100(1/8)		200(1/4)	
Output Power	Rated Output Voltage	VAC Three-Phase 200 ( varies depending on the power supply voltage and load condition)					
	Rated Output Current	A 0.7			1.4		
Power Supply Input	Rated Voltage	VAC Single-Phase 100-120 ±10%	VAC Single-Phase 200-240 ±10%	VAC Three-Phase 200-240 ±10%	VAC Single-Phase 100-120 ±10%	VAC Single-Phase 200-240 ±10%	VAC Three-Phase 200-240 ±10%
	Rated Frequency	Hz 50/60 ± 5%					
Control Characteristics/ Performance	Control Method	Sinusoidal PWM method (V/f control)					
	Speed Setting Range	6.6~80Hz (200~2400 r/min)					
	Acceleration / Deceleration Time	0.1~30 s (at 80Hz)					
	Speed Setting Method	Speed potentiometer on the inverter front panel / DC voltage input (0~10VDC)					
Function	Voltage / Frequency Characteristics	Selectable from among 5 levels according to the motor output power using rotary switches					
	Input Signal	Photocoupler Input: Input resistance 3.3kΩ Driven by + 15V internal power supply RUN/STUP, FWD/REV, Alarm reset					
	Output Signal	Open-collector output: 26.4VDC, 10mA max. Running output, Alarm output					
	Set Speed Display	The set speed out motor <sup>*1</sup> is displayed.					
	Remote / Local Switching RUN / STOP, FWD / REV	Operation using the RUN/STAND-BY switch or external input signal can be selected. (Factory setting : Local )					
	Carrier Frequency Switching	The carrier frequency can be switched if you want to reduce leak current from the cable connecting the inverter and motor. (Factory setting : 15kHz)					
	Sink / Source Switching	Sink input ( 0V, common) or source input ( 24V, common ) can be selected. (Factory setting : Source)					
Protective Function	Frequency / Speed Display Switching	The speed display can be switched to the set frequency or set speed. (Factory setting: Frequency)					
	Switching to Speed Display Based on Gear Ratio <sup>*2</sup>	The set speed shown on the speed display can be changed to the speed based on the gear ratio. One of 96 levels can be set using two rotary switches. (Factory setting: Gear ratio 1:1)					
		If any of the following protective functions is activated, the motor will be stopped by the means of base blocking action: <ul style="list-style-type: none"> <li>• Overcurrent protection : The inverter output current exceeded approximately 200% of the rated output current.</li> <li>• Circuit overheat protection : The internal temperature of the inverter rose beyond the allowable level.</li> <li>• Overvoltage protection : The internal voltage of the inverter exceeded the allowable level.</li> <li>• Undervoltage protection : The internal voltage of the inverter dropped to below the allowable level.</li> <li>• Motor overheat protection : The built-in thermal protector of the motor was actuated, or the wiring between the motor and inverter has a missing phase.<sup>*3</sup></li> <li>• Circuit error : An error occurred in the built-in CPU of the inverter etc.</li> <li>• Overload protection : The inverter output current has remained above approximately 150% of the rated output current of the inverter for approximately 1 minute.</li> <li>• Setting error : The output select switch or gear ratio setting switch was set to a value outside the setting range.</li> <li>• Ground fault protection : Ground fault occurred on the outside of the inverter, and ground fault current flowed.</li> </ul>					
Wiring Distance between Inverter and Motor		20 m max. ( when the connection cable <b>CC20AC04</b> is used )					
Cooling Condition		Natural ventilation					
Display	7-Segment Display	Set speed, Alarm code					
	LED Indicators	POWER, Unit of set speed display ( r/min, Hz )					
Mass	kg (lb.)	0.4 (0.88)			0.5 (1.1)		

\*1 Different from the actual speed of the motor shaft.

\*2 This function is disabled in the frequency display mode.

\*3 Excluding motors with output of 6 W.

## General Specifications

### Inverter

Item	Specifications	
Insulation Resistance	100 MΩ or more when measured by a 500 VDC megger between the main circuit terminal and ground terminal (control circuit terminal) after continuous operation under normal ambient temperature and humidity.	
Dielectric Strength	Sufficient to withstand 1.85 kV at 50 Hz or 60 Hz applied between the main circuit terminal and ground terminal (control circuit terminal) for 1 minute after continuous operation under normal ambient temperature and humidity.	
Operating Environment	Ambient Temperature	-10~+50°C (+14~122°F) (non-freezing)
	Ambient Humidity	95% or less (non-condensing)
	Atmosphere	No corrosive gases or dust
Degree of Protection	IP10 (IP20 for inverter front panel)	

Note: Do not measure insulation resistance or perform the dielectric strength test while the motor and inverter are connected.

## Safety Standard and CE Marking of Inverter

Model	Standards	Certification Body	Standards File No.	CE Marking
Inverter	UL508C CSA C22.2 No.14	UL	E171462	Low voltage Directives EMC Directives
	EN50178			

• The I/O signal terminals are protected by reinforced insulation.

### Use Conditions under EN Standards

- Protective earth:** The inverter has been designed and evaluated as Class I equipment. Therefore, measures are needed to protect against electrical shock, such as providing a protective grounding or incorporating the inverter in the equipment to prevent contact with the bare hands.
- Power supply:** The inverter has been designed and evaluated under Overvoltage category II.
- Surroundings:** The inverter has been designed and evaluated in an environment with pollution degree 2. When using the inverter in an environment with pollution degree 3, it must be protected with an IP54 enclosure.
- EMC:** The EMC value changes according to the wiring and layout. Therefore, the final EMC level must be checked with the inverter incorporated in the user's equipment. If you require EMC data of this product, please contact your nearest Oriental Motor office.

### Compliance Conditions under EN Standards

**Incorporation in equipment**  
 Overvoltage category: II  
 Pollution degree: 2  
 Electrical shock protection: Class I equipment

### Applicable EMC Standards

<b>EMI</b>	Emission Tests: Radiated Emission Test: Conducted Emission Test:	EN61000-6-4 EN55011 EN55011
<b>EMS</b>	Immunity Tests: Electrostatic Discharge Immunity Test: Radiation Field Immunity Test: Fast Transient/Burst Immunity Test: Surge Immunity Test: Conductive Noise Immunity Test: Voltage Dip Immunity Test: Voltage Interruption Immunity Test:	EN61000-6-2 IEC61000-4-2 IEC61000-4-3 IEC61000-4-4 IEC61000-4-5 IEC61000-4-6 IEC61000-4-11 IEC61000-4-11

# Gearmotor - Torque Table

## Parallel Shaft

◇ World K Series, FPW Series, BH Series

Unit = Upper values: N-m/ Lower values: lb-in

Model Motor / Gearhead	Gear Ratio Set Frequency Hz (Set speed r/min)																				
		3	3.6	5	6	7.5	9	12.5	15	18	25	30	36	50	60	75	90	100	120	150	180
2IK6GN-SW2 / 2GN□SA	15-50	0.12	0.14	0.20	0.24	0.30	0.36	0.50	0.60	0.71	0.89	1.1	1.3	1.6	1.9	2.4	2.9	3	3	3	3
	(450-1500)	1.06	1.23	1.77	2.1	2.6	3.1	4.4	5.3	6.2	7.8	9.7	11.5	14.1	16.8	21	25	26	26	26	26
4IK25GN-SW2 / 4GN□SA	10-50	0.46	0.55	0.77	0.92	1.2	1.4	1.9	2.3	2.8	3.5	4.2	5.0	6.3	7.5	8	8	8	8	8	8
	(300-1500)	4.0	4.8	6.8	8.1	10.6	12.3	16.8	20	24	30	37	44	55	66	70	70	70	70	70	70
5IK40GN-SW2 / 5GN□SA	6.6-50	0.73	0.87	1.2	1.5	1.8	2.2	3.0	3.6	4.4	5.5	6.6	7.9	9.9	10	10	10	10	10	10	10
	(200-1500)	6.4	7.6	10.6	13.2	15.9	19.4	26	31	38	48	58	69	87	88	88	88	88	88	88	88
5IK60GE-SW2 / 5GE□SA	10-50	1.1	1.3	1.8	2.2	2.7	3.3	4.1	4.9	5.9	7.4	8.9	10.7	14.9	17.8	19.9	20	20	20	20	20
	(300-1500)	9.7	11.5	15.9	19.4	23	29	36	43	52	65	78	94	131	157	176	177	177	177	177	177
5IK90GE-SW2 / 5GE□SA	10-60	1.2	1.5	2.0	2.4	3.0	3.6	4.6	5.5	6.6	8.3	9.9	11.9	16.5	19.8	20	20	20	20	20	20
	(300-1800)	10.6	13.2	17.7	21	26	31	40	48	58	73	87	105	146	175	177	177	177	177	177	177
FPW425S2-□	10-50	0.46	0.55	0.77	0.92	1.2	1.4	1.9	2.3	2.8	3.5	4.2	5.0	6.3	7.5	8	8	8	8	8	8
	(300-1500)	4.0	4.8	6.8	8.1	10.6	12.3	16.8	20	24	30	37	44	55	66	70	70	70	70	70	70
FPW540S2-□	6.6-50	0.73	0.87	1.2	1.5	1.8	2.2	3.0	3.6	4.4	5.5	6.6	7.9	9.9	10	10	10	10	10	10	10
	(200-1500)	6.4	7.6	10.6	13.2	15.9	19.4	26	31	38	48	58	69	87	88	88	88	88	88	88	88
FPW560S2-□	10-50	1.1	1.3	1.8	2.2	2.7	3.3	4.1	4.9	5.9	7.4	8.9	10.7	14.9	15	15	15	15	15	15	15
	(300-1500)	9.7	11.5	15.9	19.4	23	29	36	43	52	65	78	94	131	132	132	132	132	132	132	132
FPW690S2-□	6.6-50	1.7	2.0	2.8	3.3	4.1	5.0	6.2	7.4	8.9	12.4	14.9	17.9	22.4	26.9	30	30	30	30	30	30
	(200-1500)	15.0	17.7	24	29	36	44	54	65	78	109	131	158	198	230	260	260	260	260	260	260
BHI62ST-□	20-40	4.0	4.8	6.7	8.0	10.1	12.1	16.0	19.2	23.1	32.0	38.4	40	40	40	40	40	40	40	40	40
	(600-1200)	35	42	59	70	89	107	141	169	200	280	330	350	350	350	350	350	350	350	350	350

- Enter the gear ratio in the box (□) within the gearhead model name.
- A colored background □ indicates gear shaft rotation in the same direction as the motor shaft, while the others rotate in the opposite direction.
- The set speed indicates the motor's synchronous speed. The actual speed varies depending on the load condition. Check the speed - torque characteristics on pages 4.

## Right-Angle Shaft

◇ World K Series, BH Series

Unit = Upper values: N-m/ Lower values: lb-in

Model Motor / Gearhead	Gear Ratio Set Frequency Hz (Set speed r/min)																				
		3	3.6	5	6	7.5	9	12.5	15	18	25	30	36	50	60	75	90	100	120	150	180
4IK25GN-SW2 / 4GN□RH	10-50 (300-1500)	Rating	-	-	-	-	-	0.95	1.4	1.7	2.3	3.2	3.9	4.7	5.6	6.7	8	8	8	8	8
		Startup	-	-	-	-	-	8.4	12.3	15.0	20	28	34	41	49	59	70	70	70	70	70
4IK25GN-SW2 / 4GN□RAA	10-50 (300-1500)	Rating	-	-	0.43	0.74	0.93	1.1	1.5	1.9	2.4	3.3	4.0	4.8	5.7	6.8	8	8	8	8	8
		Startup	-	-	3.8	6.5	8.2	9.7	13.2	16.8	21	29	35	42	50	60	70	70	70	70	70
5IK40GN-SW2 / 5GN□RH	6.6-50 (200-1500)	Rating	-	-	-	-	1.3	1.6	2.5	3.0	3.6	5.1	6.2	7.4	8.9	10	10	10	10	10	10
		Startup	-	-	-	-	11.5	14.1	22	26	31	45	54	65	78	88	88	88	88	88	88
5IK40GN-SW2 / 5GN□RAA	6.6-50 (200-1500)	Rating	-	-	0.98	1.2	1.5	1.8	2.6	3.2	3.8	5.3	6.3	7.6	9.0	10	10	10	10	10	10
		Startup	-	-	8.6	10.6	13.2	15.9	23	28	33	46	55	67	79	88	88	88	88	88	88
5IK60GE-SW2 / 5GE□RH	10-50 (300-1500)	Rating	-	-	1.2	1.5	2.1	2.6	3.7	4.5	5.5	7.7	9.6	13.3	16.0	20	20	20	20	20	20
		Startup	-	-	10.6	13.2	18.5	23	32	39	48	68	69	84	117	141	177	177	177	177	177
5IK60GE-SW2 / 5GE□RAA	10-50 (300-1500)	Rating	-	-	1.5	1.8	2.4	2.9	4.2	5.1	6.1	8.6	8.8	10.6	14.8	17.8	20	20	20	20	20
		Startup	-	-	13.2	15.9	21	24	34	41	50	69	71	85	119	143	177	177	177	177	177
5IK90GE-SW2 / 5GE□RH	10-60 (300-1800)	Rating	-	-	1.4	1.8	2.4	2.9	4.2	5.1	6.1	8.6	8.8	10.6	14.8	17.8	20	20	20	20	20
		Startup	-	-	12.3	15.9	21	25	37	45	53	76	77	93	130	157	177	177	177	177	177
5IK90GE-SW2 / 5GE□RAA	10-60 (300-1800)	Rating	0.98	1.2	1.6	2.1	2.6	3.2	4.4	5.3	6.3	8.8	9.0	10.8	15.0	18.0	20	20	20	20	20
		Startup	8.6	10.6	14.1	18.5	23	28	38	46	55	77	79	95	132	159	177	177	177	177	177
BHI62ST-□RH BHI62ST-□RA	20-40 (600-1200)	Rating	-	-	5.4	6.5	8.2	9.8	13.6	16.3	19.6	27.2	32.6	36.0	40.0	43.0	47.0	51.5	54.5	60	60
		Startup	-	-	47	58	72	86	120	144	173	240	280	310	350	380	410	450	480	530	530

- Enter the gear ratio in the box (□) within the gearhead model name.
- The set speed indicates the motor's synchronous speed. The actual speed varies depending on the load condition. Check the speed - torque characteristics on pages 4.

## Speed - Torque Characteristics

(The characteristics shown below are only applicable for the motors only)

**FE100**■/2IK6GN(A)-SW2

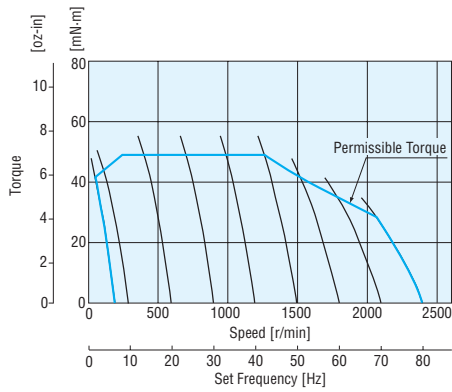

**FE100**■/4IK25GN(A)-SW2, 4IK25GN(A)-SW2T  
**FE100**■/FPW425S2-□

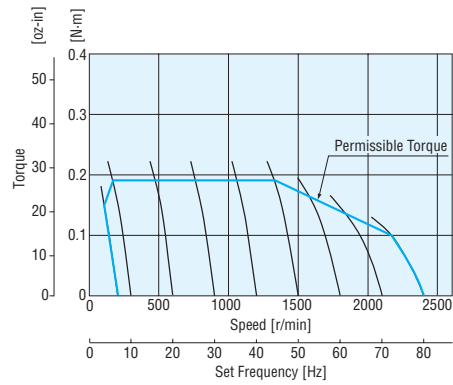

**FE100**■/5IK40GN(A)-SW2, 5IK40GN(A)-SW2T  
**FE100**■/FPW540S2-□

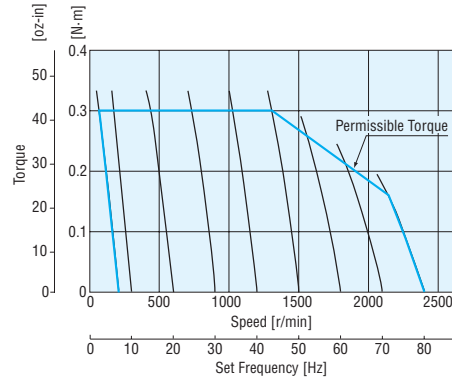

**FE100**■/5IK60GE(A)-SW2, 5IK60GE(A)-SW2T

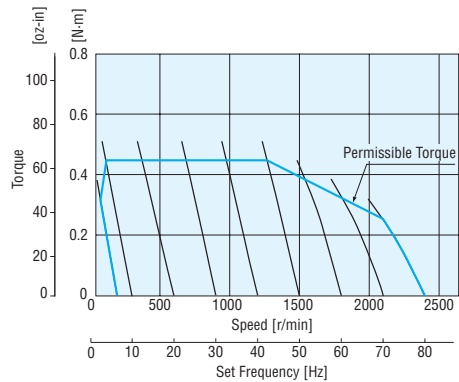

**FE100**■/FPW560S2-□

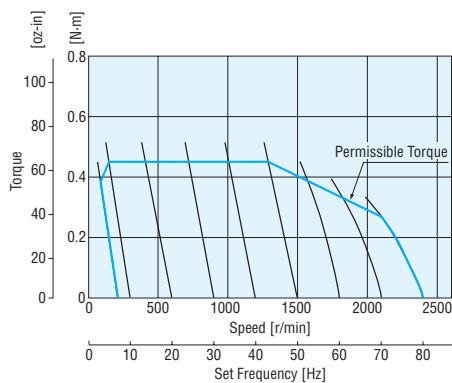

**FE100**■/5IK90GE(A)-SW2, 5IK90GE(A)-SW2T

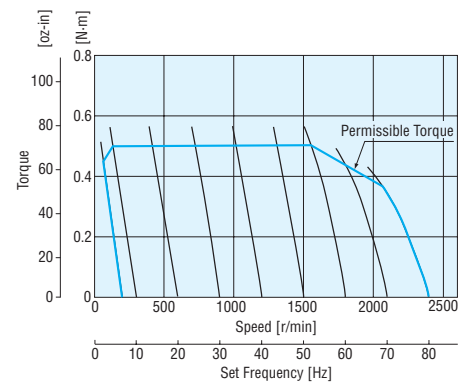

**FE100**■/FPW690S2-□

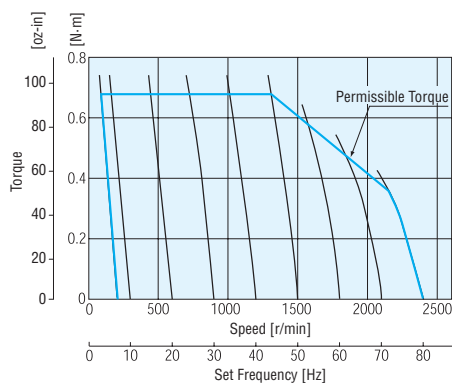

**FE200**■/BHI62ST-□ (RH, RA), BHI62ST-A

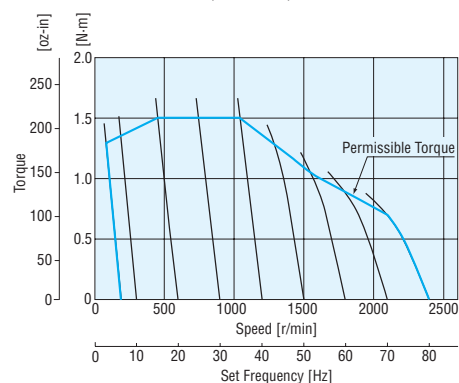

- Enter the letter representing the voltage (A, C or S) in the box (■) within the model name.  
Enter the gear ratio in the box (□) within the model names.

Note: The speed or frequency shown on the display is the current setting. It is not the actual speed of the motor output shaft. The actual speed varies depending on the size of the load.



**■ Dimensions Unit=mm (in.)**  
**FE100□, FE200□**

◇ Control Unit Panel Cut-Out

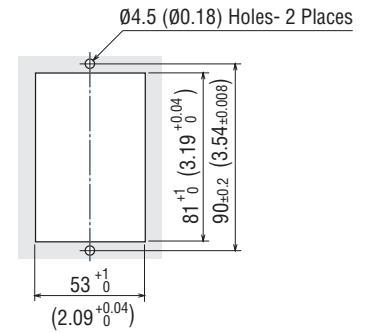
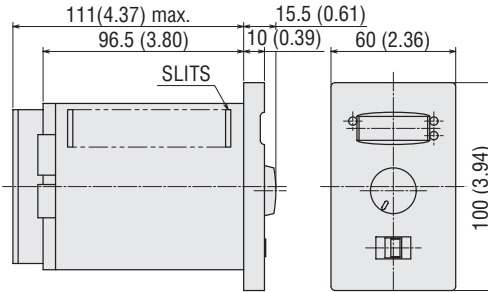
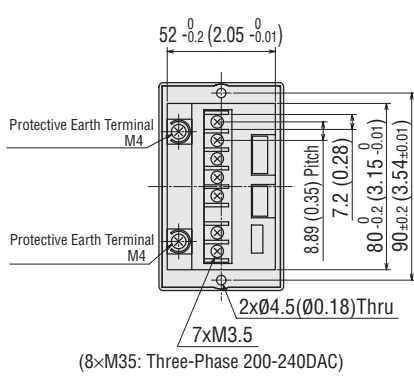

Inverter Model	L1		L2		Mass		CAD
	mm	inch	mm	inch	Kg	lb.	
<b>FE100A</b> <b>FE100C</b> <b>FE100S</b>	111	4.37	96.5	3.80	0.4	0.88	A417
<b>FE200A</b> <b>FE200C</b> <b>FE200S</b>	141	5.55	126.5	4.98	0.5	1.1	A418

**Accessories (Sold separately)**

**■ Connection Cables**

This cable is needed when connecting the motor and inverter or extending their wiring length. Cables of six lengths from 1 to 20 m are available.



Model	Length L m (ft.)
<b>CC01AC04</b>	1 (3.3)
<b>CC02AC04</b>	2 (6.6)
<b>CC03AC04</b>	3 (9.8)
<b>CC05AC04</b>	5 (16.4)
<b>CC10AC04</b>	10 (32.8)
<b>CC20AC04</b>	20 (65.6)

**● Dimensions Unit=mm (in.)**

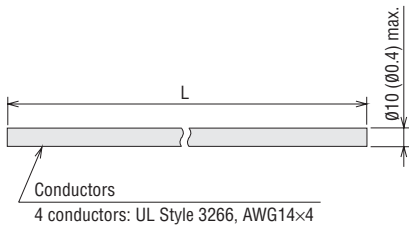

**■ Front Cover PAFCO1**

A clear cover placed over the front panel.

This cover prevents accidental contact with the speed potentiometer and resulting shift in the set speed. (The front cover is not waterproof.)



**● Dimensions Unit=mm (in.)**

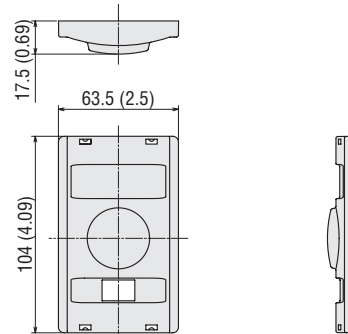

This product is manufactured at a plant certified with the international standards ISO 9001 (for quality assurance) and ISO 14001 (for systems of environmental management).

Specifications are subject to change without notice.  
 This catalog was published in Oct, 2007.

**ORIENTAL MOTOR U.S.A. CORP.**

**Western Sales and Customer Service Center**

Tel: (310) 715-3301 Fax: (310) 225-2594

Los Angeles

Tel: (310) 715-3301

San Jose

Tel: (408) 392-9735

**Midwest Sales and Customer Service Center**

Tel: (847) 285-5100 Fax: (847) 843-4121

Chicago

Tel: (847) 285-5100

Toronto

Tel: (905) 502-5333

Dallas

Tel: (214) 432-3386

**Eastern Sales and Customer Service Center**

Tel: (781) 848-2426 Fax: (781) 848-2617

Boston

Tel: (781) 848-2426

New York

Tel: (973) 359-1100

Charlotte

Tel: (704) 696-1036

**Technical Support**

Tel: (800) 468-3982 / 8:30 a.m. to 5:00 p.m., P.S.T. (M-F)  
 7:30 a.m. to 5:00 p.m., C.S.T. (M-F)

E-mail: techsupport@orientalmotor.com

**Obtain Specifications, Online Training**

and Purchase Products at:

[www.orientalmotor.com](http://www.orientalmotor.com)