

Servo Motors

# NX Series

Introduction

NX Series

Accessories

Introduction

NX

Accessories

# Tuning-Free Servo Motor and Driver Package NX Series

● Additional Information ●  
 Technical reference → Page G-1  
 Safety standards → Page H-2

The tuning-free servo motor and driver package in the **NX Series** are easy to operate and allows for smooth operation with large inertial loads and belt mechanisms.



- For detailed product safety standard information including standards, file number and certification body, please visit [www.orientalmotor.com](http://www.orientalmotor.com).
- UL/CSA standards pending



## Features

### ● Easy Operation

As with a stepping motor, stable operation can be achieved in high inertia drive and belt mechanism drive applications without gain adjustment. Also, adjusting the gain manually enables operation under even more stringent load conditions.

### ◇ Achieves High Inertia Drive

With automatic tuning, operation up to 50 times the rotor inertia is possible. With manual tuning, operation up to 100 times the rotor inertia is possible.

### ◇ Achieves Smooth Operation with Belt Mechanisms

Belt mechanisms can be operated with the same performance as a stepping motor without the occurrence of vibration before stopping.

### ● Conventional Models

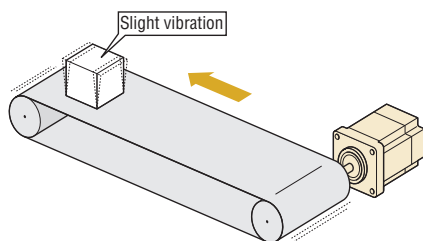

### ● NX Series

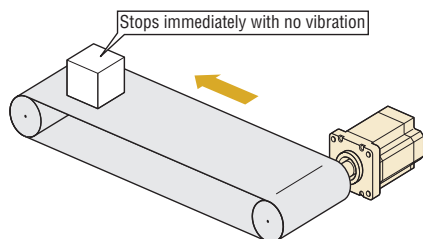

### ● Easy Handling

Basic settings and adjustments are made with switches and potentiometers on the front panel. This design allows for easy control without a computer and even saves the hassle of complicated UP and DOWN key operations.



### ● Easy Setting and Easy Monitoring

By using the separately sold control module (**OPX-2A**) or data setting software (**MEXE02**), it is possible to perform changing of parameters, function setting and monitoring that is better suited to your system.

### ● Operating Status Waveform Monitoring\*



\* Monitoring the operating status waveform requires the data setting software (**MEXE02**), which is sold separately.

## ● 4 Control Modes

This servo unit can operate in 4 control modes. Also, with the separately sold control module (**OPX-2A**) or data setting software (**MEXE02**), the functions of each control mode can be extended.

Extended functions → Page B-43

### ◇ Position Control

The built-in, high-resolution 20-bit absolute encoder enables highly accurate positioning.

### ● High Speed and High Response

High-speed positioning can be performed utilizing the high-speed and high-response characteristics.

Maximum Speed **5500 r/min**

Factory Settling Time **60 to 70 ms**

### NX620AA-3

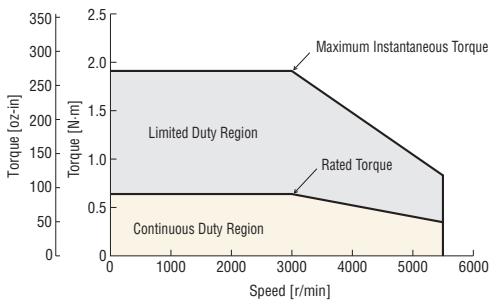

### ● Damping Control

Eliminates load resonance by adjusting the potentiometer. This adjustment can be made easily and without searching for the resonance frequency.

#### <Application Example: Image inspection equipment>

Camera vibration during stopping can be suppressed by using the damping control.

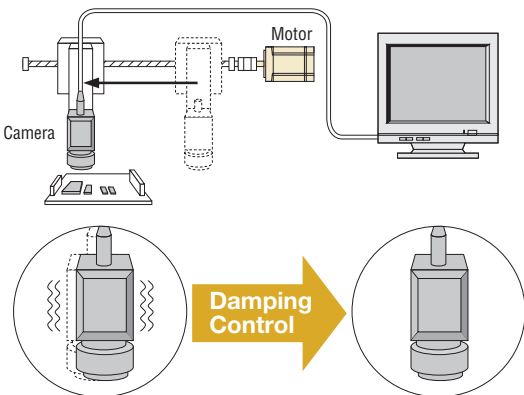

### ● Absolute System

Use as an absolute system by attaching an optional battery (sold separately) is possible. The current position of the encoder can be stored, so resetting after a blackout or similar occurrence is easy.

### ◇ Speed Control

The reduction of motor cogging torque and the use of a high-resolution encoder have substantially reduced variation in rotation in the low-speed range (the flutter characteristic), resulting in smooth operation even at low speeds.

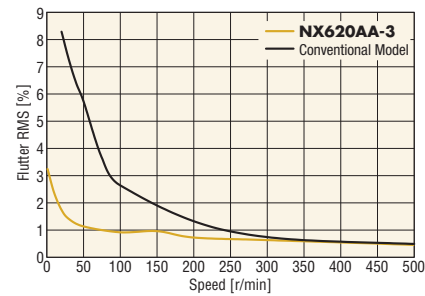

### ◇ Torque Control

Variation of the generated torque relative to the set torque (torque accuracy) has been improved, resulting in highly accurate torque control.

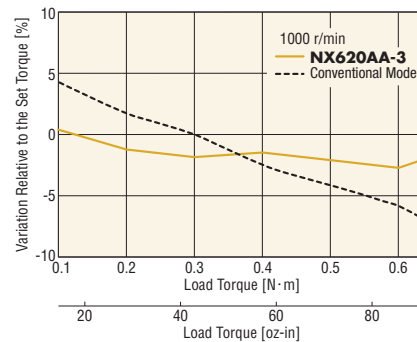

### ◇ Tension Control

Tension control such as winding film can be easily performed without using a tension detector or control equipment.

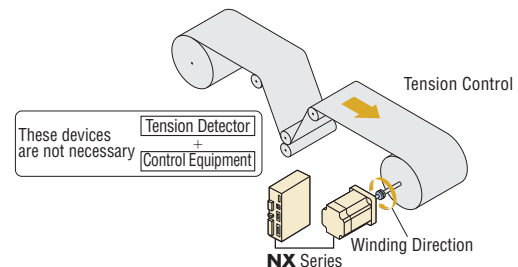

### ● Degree of Protection IP65

These motors conform to IP65 and are ideal for use in environments requiring dust resistance and water resistance. (Standard type, electromagnetic brake type, **PS** geared type: excluding installation surface and connector locations, **PJ** geared type: excluding connector locations)

### ● Simple Connections with Included Cables

The **NX** Series comes with cables 3 m (9.8 ft.) to connect the motor and driver. If you need cables longer than 3 m (9.8 ft.) or cables offering superior flexibility, appropriate cables are available as accessories (sold separately).



● **Separate Main Power Supply and Control Power Supply**

A control power supply terminal that is separate from the main power supply is provided. Even when the main power supply is cut off in the case of, for example, an emergency stop, operations such as position detection and alarm contents checking can be performed if 24 VDC power is supplied to the control power supply terminal. (Operation with only the main power supply is also possible.)

● **Conforms to Semiconductor Equipment and Materials International Standards “SEMI F47”**

- Conforms to SEMI Standards regarding power supply voltage drop.
- Effective for use in semiconductor equipment. (Always evaluate the product with it mounted on actual equipment.)

● **High Performance Geared Motors**

◇ **High Permissible Torque and Wide Permissible Speed Range**

These geared motors with high permissible torque fully utilize the motor output torque.

**NX65AA-PS25-3**

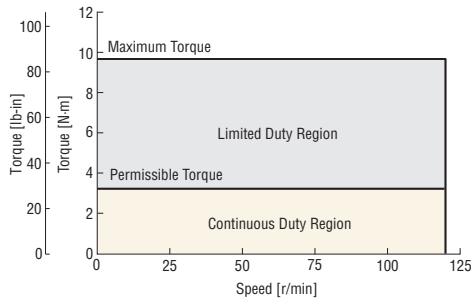

● **PS Geared Type**

◇ **Low Backlash**

The backlash is 15 arc minutes (0.25°) max. These motors can be used in a wide range of applications.

◇ **Compact and Lightweight Design**

Compared to **PJ** geared types, these are compact, lightweight geared motors.

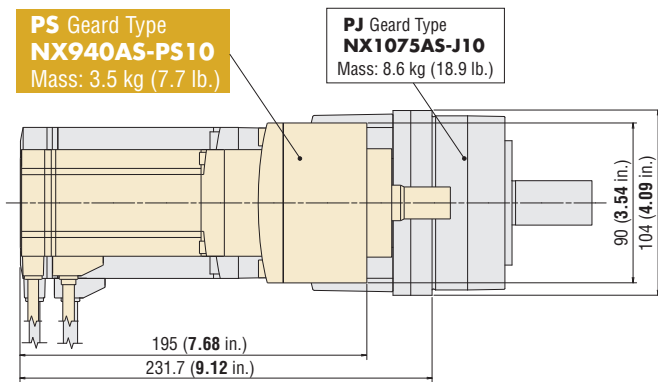

● **PJ Geared Type**

◇ **Non-Backlash**

These geared motors use high accuracy gears with an angular transmission accuracy of 4 arc minutes (0.067°) and backlash of 3 arc minutes (0.05°).

◇ **Surface Installation is Possible**

There are screw holes that permit installation of a load directly on the rotating surface integrated with the shaft. Since the load can be installed here directly (surface installation), the design is simple when using an index table.

Screw Hole for Load Installation

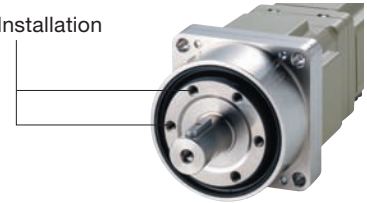

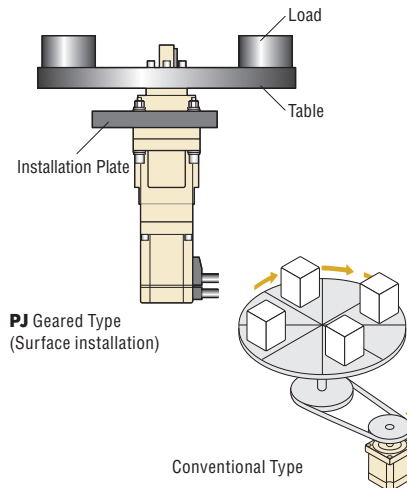

● **Application Example with an Index Table**

Parts that had been necessary, such as pulleys and belts, are no longer needed.



## ● Characteristics Comparison for Geared Motor

The motor and driver package are available in comes in 3 geared motor frame sizes ranging from 60 mm (2.36 in.) to 104 mm (4.09 in.).  
 [“□60 (□2.36)” indicates a motor frame size of 60 mm (2.36 in.)]

Geared Type	Features	Power Supply Input	Output Power				
			50 W (1/15 HP)	100 W (1/8 HP)	200 W (1/4 HP)	400 W (1/2 HP)	750 W (1 HP)
<b>PS</b> Geared Type (Planetary gear mechanism) 	<ul style="list-style-type: none"> <li>• High Speed (Low gear ratio)</li> <li>• High Permissible Torque/Maximum Torque</li> <li>• Center Shaft</li> <li>• Gear Ratio Types 5, 10, 25</li> </ul>	Single-Phase 100-115 VAC	□60 (□2.36)	□60 (□2.36)	□90 (□3.54)		
		Single-Phase/Three-Phase 200-230 VAC	□60 (□2.36)	□60 (□2.36)	□90 (□3.54)		
		Three-Phase 200-230 VAC				□90 (□3.54)	
<b>PJ</b> Geared Type (Planetary gear mechanism) 	<ul style="list-style-type: none"> <li>• High Speed (Low gear ratio)</li> <li>• High Positioning Accuracy</li> <li>• High Permissible Torque/Maximum Torque</li> <li>• Center Shaft</li> <li>• Surface installation is possible</li> <li>• Gear Ratio Types 5, 10, 25</li> </ul>	Three-Phase 200-230 VAC					□104 (□4.09)

## System Configuration

### Standard Type with Electromagnetic Brake

An example of a single axis system configuration with the **SG8030J** controller in position control mode is shown below.

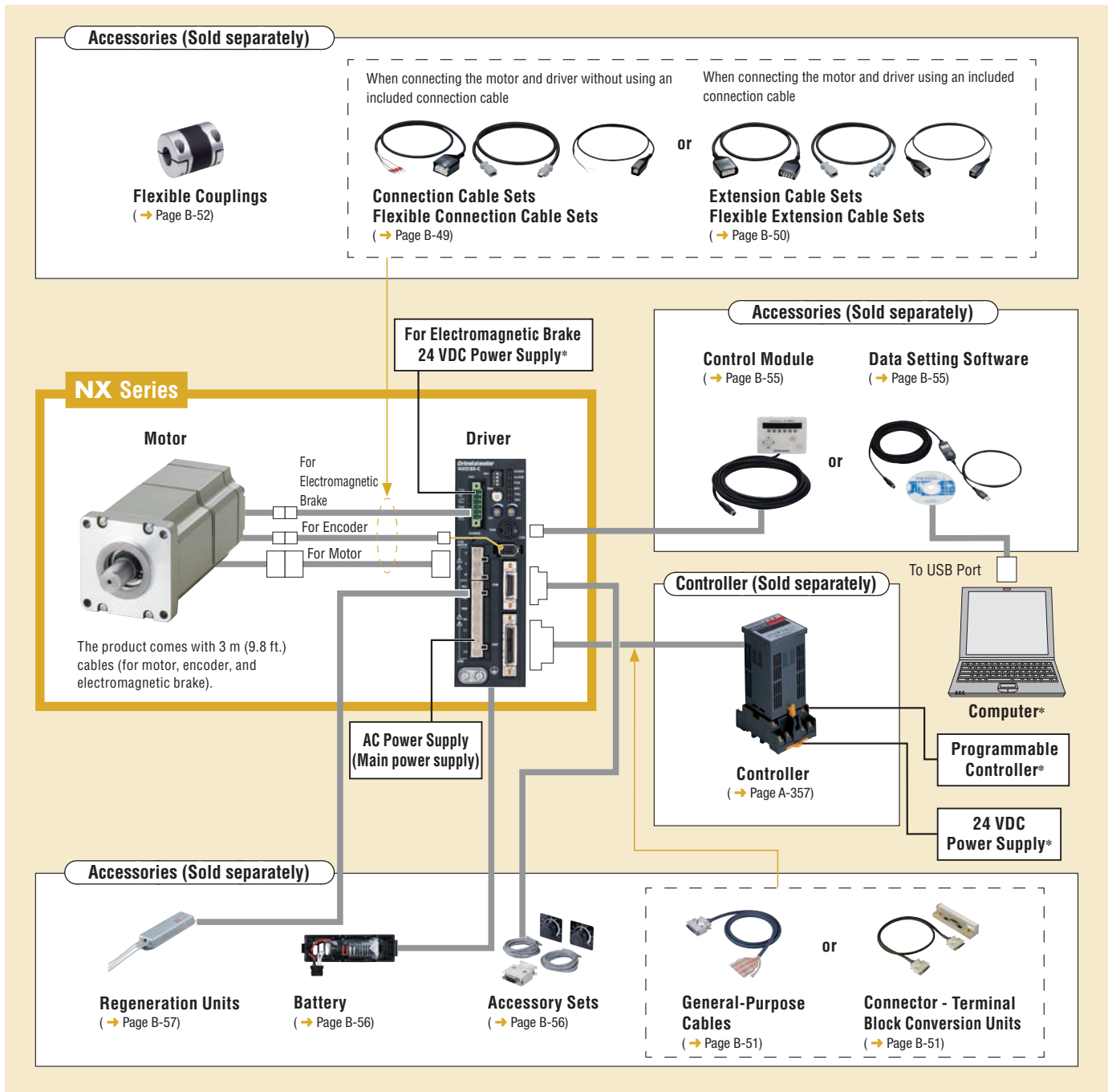

### Example of System Configuration

NX Series	Sold Separately						
	Controller	Flexible Coupling	Regeneration Unit	Battery	Accessory Set	Connector - Terminal Block Conversion Unit [1 m (3.3 ft.)]	Data Setting Software
<b>NX620MC-3</b>	<b>SG8030J-D</b>	<b>MCV300814</b>	<b>RGB100</b>	<b>BAT01A</b>	<b>AS-SV2</b>	<b>CC36T1</b>	<b>MEXE02</b>

The system configuration shown above is an example. Other combinations are available.

\*Not supplied

## Product Number Code

# NX 6 10 M A - PS 25 - 3

① ② ③ ④ ⑤ ⑥ ⑦ ⑧

①	Series Name	<b>NX: NX Series</b>
②	Motor Frame Size	<b>4:</b> 42 mm (1.65 in.) <b>6:</b> 60 mm (2.36 in.) [60 mm (2.36 in.)] <b>9:</b> 85 mm (3.35 in.) [90 mm (3.54 in.)] <b>10:</b> [104 mm (4.09 in.)] [ ] indicates the frame size for the gearhead
③	Output Power	<b>5:</b> 50 W (1/15 HP) <b>10:</b> 100 W (1/8 HP) <b>20:</b> 200 W (1/4 HP) <b>40:</b> 400 W (1/2 HP) <b>75:</b> 750 W (1 HP)
④	Configuration	<b>A:</b> Standard <b>M:</b> Electromagnetic Brake Type
⑤	Power-Supply Input	<b>A:</b> Single-Phase 100–115 VAC <b>C:</b> Single-Phase/Three-Phase 200–230 VAC <b>S:</b> Three-Phase 200–230 VAC
⑥	Gear Type	<b>PS: PS</b> Geared Type <b>J: PJ</b> Geared Type Blank: Standard Type
⑦	Gear Ratio	
⑧	Cable Length (Included)	<b>3:</b> 3 m (9.8 ft.)

## Product Line

### Standard Type

Power-Supply Input	Output Power	Model
Single-Phase 100-115 VAC	50 W (1/15 HP)	<b>NX45AA-3</b>
	100 W (1/8 HP)	<b>NX410AA-3</b>
	200 W (1/4 HP)	<b>NX620AA-3</b>
Single-Phase/Three-Phase 200-230 VAC	50 W (1/15 HP)	<b>NX45AC-3</b>
	100 W (1/8 HP)	<b>NX410AC-3</b>
	200 W (1/4 HP)	<b>NX620AC-3</b>
Three-Phase 200-230 VAC	400 W (1/2 HP)	<b>NX640AS-3</b>
	750 W (1 HP)	<b>NX975AS-3</b>

### PS Geared Type

Power-Supply Input	Output Power	Model
Single-Phase 100-115 VAC	50 W (1/15 HP)	<b>NX65AA-PS5-3</b>
		<b>NX65AA-PS10-3</b>
		<b>NX65AA-PS25-3</b>
	100 W (1/8 HP)	<b>NX610AA-PS5-3</b>
		<b>NX610AA-PS10-3</b>
		<b>NX610AA-PS25-3</b>
	200 W (1/4 HP)	<b>NX920AA-PS5-3</b>
		<b>NX920AA-PS10-3</b>
		<b>NX920AA-PS25-3</b>
Single-Phase/Three-Phase 200-230 VAC	50 W (1/15 HP)	<b>NX65AC-PS5-3</b>
		<b>NX65AC-PS10-3</b>
		<b>NX65AC-PS25-3</b>
	100 W (1/8 HP)	<b>NX610AC-PS5-3</b>
		<b>NX610AC-PS10-3</b>
		<b>NX610AC-PS25-3</b>
	200 W (1/4 HP)	<b>NX920AC-PS5-3</b>
		<b>NX920AC-PS10-3</b>
		<b>NX920AC-PS25-3</b>
Three-Phase 200-230 VAC	400 W (1/2 HP)	<b>NX940AS-PS5-3</b>
		<b>NX940AS-PS10-3</b>
		<b>NX940AS-PS25-3</b>

### PJ Geared Type

Power-Supply Input	Output Power	Model
Three-Phase 200-230 VAC	750 W (1 HP)	<b>NX1075AS-J5-3</b>
		<b>NX1075AS-J10-3</b>
		<b>NX1075AS-J25-3</b>

### Standard Type with Electromagnetic Brake

Power-Supply Input	Output Power	Model
Single-Phase 100-115 VAC	50 W (1/15 HP)	<b>NX45MA-3</b>
	100 W (1/8 HP)	<b>NX410MA-3</b>
	200 W (1/4 HP)	<b>NX620MA-3</b>
Single-Phase/Three-Phase 200-230 VAC	50 W (1/15 HP)	<b>NX45MC-3</b>
	100 W (1/8 HP)	<b>NX410MC-3</b>
	200 W (1/4 HP)	<b>NX620MC-3</b>
Three-Phase 200-230 VAC	400 W (1/2 HP)	<b>NX640MS-3</b>
	750 W (1 HP)	<b>NX975MS-3</b>

### PS Geared Type with Electromagnetic Brake

Power-Supply Input	Output Power	Model
Single-Phase 100-115 VAC	50 W (1/15 HP)	<b>NX65MA-PS5-3</b>
		<b>NX65MA-PS10-3</b>
		<b>NX65MA-PS25-3</b>
	100 W (1/8 HP)	<b>NX610MA-PS5-3</b>
		<b>NX610MA-PS10-3</b>
		<b>NX610MA-PS25-3</b>
	200 W (1/4 HP)	<b>NX920MA-PS5-3</b>
		<b>NX920MA-PS10-3</b>
		<b>NX920MA-PS25-3</b>
Single-Phase/Three-Phase 200-230 VAC	50 W (1/15 HP)	<b>NX65MC-PS5-3</b>
		<b>NX65MC-PS10-3</b>
		<b>NX65MC-PS25-3</b>
	100 W (1/8 HP)	<b>NX610MC-PS5-3</b>
		<b>NX610MC-PS10-3</b>
		<b>NX610MC-PS25-3</b>
	200 W (1/4 HP)	<b>NX920MC-PS5-3</b>
		<b>NX920MC-PS10-3</b>
		<b>NX920MC-PS25-3</b>
Three-Phase 200-230 VAC	400 W (1/2 HP)	<b>NX940MS-PS5-3</b>
		<b>NX940MS-PS10-3</b>
		<b>NX940MS-PS25-3</b>

### PJ Geared Type with Electromagnetic Brake

Power-Supply Input	Output Power	Model
Three-Phase 200-230 VAC	750 W (1 HP)	<b>NX1075MS-J5-3</b>
		<b>NX1075MS-J10-3</b>
		<b>NX1075MS-J25-3</b>

● If you need cables longer than 3 m (9.8 ft.) or cables offering excellent flexibility, select appropriate cables from the accessories (sold separately). Refer to page B-48 for details.

The following items are included in each product.

Motor, Driver, Cable for Motor\*, Cable for Encoder\*, Cable for Electromagnetic Brake\* (Electromagnetic brake type only), Connector for I/O Signal, Motor Connector, Connector for Regeneration Unit Input/Main Power Input Terminals, Connector for 24 VDC Power-Supply Input/Regeneration Unit Thermal Input/Electromagnetic Brake Terminals, Connector Wiring Lever, Operating Manual, User Manual (CD-ROM)

\*The product comes with 3 m (9.8 ft.) cables including a cable for motor, cable for encoder, and cable for electromagnetic brake (electromagnetic brake type only).

# Standard Type Frame Size 42 mm (1.65 in.), 60 mm (2.36 in.), 85 mm (3.35 in.)

## Specifications RoHS

● UL/CSA standards pending CE

Model	Standard Electromagnetic Brake Type	NX45A□-3	NX410A□-3	NX620A□-3	NX640AS-3	NX975AS-3	
		NX45M□-3	NX410M□-3	NX620M□-3	NX640MS-3	NX975MS-3	
Rated Output Power	W (HP)	50 (1/15)	100 (1/8)	200 (1/4)	400 (1/2)	750 (1)	
Rated Speed	r/min	3000					
Maximum Speed	r/min	5500					
Rated Torque	N·m (oz·in)	0.159 (22)	0.318 (45)	0.637 (90)	1.27 (180)	2.39 (330)	
Maximum Instantaneous Torque	N·m (oz·in)	0.478 (67)	0.955 (135)	1.91 (270)	3.82 (540)	7.16 (1010)	
Rotor Inertia	J: kg·m <sup>2</sup> (oz·in <sup>2</sup> )	0.0174×10 <sup>-4</sup> (0.095) [0.0217×10 <sup>-4</sup> (0.119)]*1	0.0290×10 <sup>-4</sup> (0.159) [0.0334×10 <sup>-4</sup> (0.183)]*1	0.162×10 <sup>-4</sup> (0.89) [0.185×10 <sup>-4</sup> (1.01)]*1	0.291×10 <sup>-4</sup> (1.59) [0.314×10 <sup>-4</sup> (1.72)]*1	0.948×10 <sup>-4</sup> (5.2) [1.03×10 <sup>-4</sup> (5.6)]*1	
Permissible Load Inertia*2	J: kg·m <sup>2</sup> (oz·in <sup>2</sup> )	1.74×10 <sup>-4</sup> (9.5)	2.90×10 <sup>-4</sup> (15.9)	16.2×10 <sup>-4</sup> (89)	29.1×10 <sup>-4</sup> (159)	94.8×10 <sup>-4</sup> (520)	
Resolution	P/R	100 to 100000 (Factory setting 1000)					
Detector		Absolute Encoder 1 rotation 20 bits, multiple rotations 16 bits					
Power-Supply Input	Voltage and Frequency	AC Main Power Supply Single-Phase 100-115 VAC -15% to +10% 50/60 Hz Single-Phase 200-230 VAC -15% to +10% 50/60 Hz Three-Phase 200-230 VAC -15% to +10% 50/60 Hz			Three-Phase 200-230 VAC -15% to +10% 50/60 Hz		
		DC Control Power Supply 24 VDC±10% 0.8 A					
	Rated Input Current*3 A	Single-Phase 100-115 VAC	1.9	2.9	4.6	-	
		Single-Phase 200-230 VAC	1.2	1.8	2.8	-	
Three-Phase 200-230 VAC		0.7	1	1.6	2.8	4.7	
Electromagnetic Brake*4	Type	Power Off Activated Type					
	Power-Supply Input	24 VDC±10%					
	Power Consumption W	6.1			7.2		
	Excitation Current A	0.25			0.3		
	Static Friction Torque N·m (oz·in)	0.159 (22)	0.318 (45)	0.637 (90)	1.27 (180)	2.39 (330)	

\*1 The brackets [ ] indicate the specifications for the electromagnetic brake type.

\*2 With automatic tuning, operation up to 50 times the rotor inertia is possible; with manual tuning, operation up to 100 times the rotor inertia is possible.

\*3 These values are for operation in the continuous duty region. For operation in the limited duty region, the maximum current is approximately 3 times the value shown.

\*4 The electromagnetic brake is for holding the position when the power supply is OFF. The electromagnetic brake cannot be used to stop the motor. A separate power supply for the electromagnetic brake is also required.

### Note

● For continuous operation of the motor at the rated values, a heat sink with aluminum plate size dimensions that are equal to or higher than those shown below is required.

**NX45**□□◇, **NX410**□□◇, **NX620**□□◇: 250×250 mm (9.84×9.84 in) Thickness 6 mm (0.24 in)

**NX640**□□◇: 300×300 mm (11.81×11.81 in) Thickness 10 mm (0.39 in)

**NX975**□□◇: 350×350 mm (13.78×13.78 in) Thickness 10 mm (0.39 in)

## Speed – Torque Characteristics

**NX45**□□-3

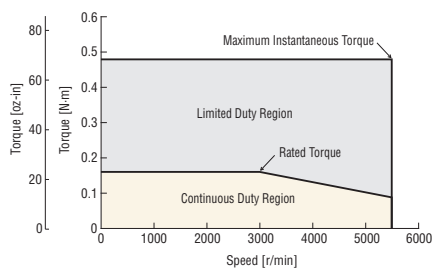

**NX410**□□-3

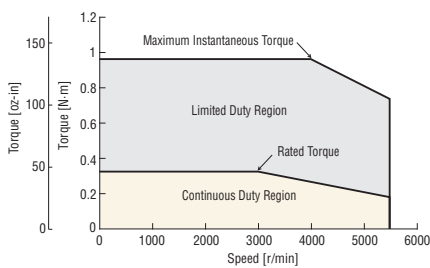

**NX620**□□-3

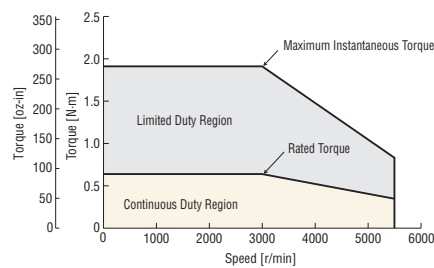

**NX640**□□S-3

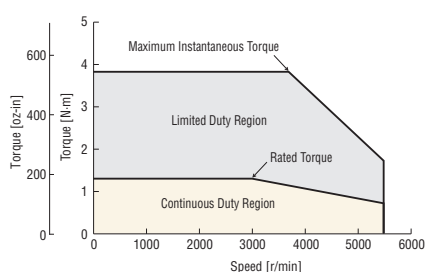

**NX975**□□S-3

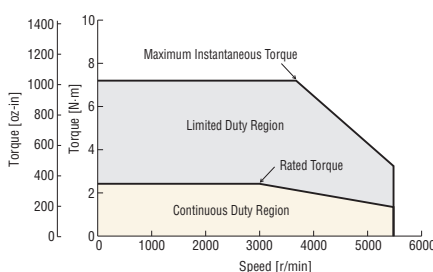

● Either **A** (standard) or **M** (electromagnetic brake type) indicating the motor configuration is entered where the box (□) is located within the product name.

Either **A** (single-phase 100-115 VAC) or **C** (single-phase 200-230 VAC/three-phase 200-230 VAC) indicating the power supply voltage is entered where the box (□) is located within the product name.

● Depending on the operating conditions, a regeneration unit may be required. Regeneration Unit → Page B-57



## PS Geared Type Frame Size 60 mm (2.36 in.)

### Specifications RoHS

● UL/CSA standards pending CE

Model	Standard	NX65A□-PS5-3	NX65A□-PS10-3	NX65A□-PS25-3	NX610A□-PS5-3	NX610A□-PS10-3	NX610A□-PS25-3
	Electromagnetic Brake Type	NX65M□-PS5-3	NX65M□-PS10-3	NX65M□-PS25-3	NX610M□-PS5-3	NX610M□-PS10-3	NX610M□-PS25-3
Rated Output Power	W (HP)	50 (1/15)			100 (1/8)		
Motor Permissible Speed	r/min	3000					
Permissible Torque	N·m (lb·in)	0.716 (6.3)	1.43 (12.6)	3.22 (28)	1.43 (12.6)	2.86 (25)	6.44 (56)
Maximum Torque	N·m (lb·in)	2.15 (19.0)	4.29 (37)	9.66 (85)	4.29 (37)	8.59 (76)	19.3 (170)
Permissible Speed Range	r/min	0 to 600	0 to 300	0 to 120	0 to 600	0 to 300	0 to 120
Rotor Inertia	J: kg·m <sup>2</sup> (oz·in <sup>2</sup> )	0.0174×10 <sup>-4</sup> (0.095) [0.0217×10 <sup>-4</sup> (0.119)]*1			0.0290×10 <sup>-4</sup> (0.159) [0.0334×10 <sup>-4</sup> (0.183)]*1		
Gearhead Internal Inertia*2	J: kg·m <sup>2</sup> (oz·in <sup>2</sup> )	0.0431×10 <sup>-4</sup> (0.24)	0.0433×10 <sup>-4</sup> (0.24)	0.0436×10 <sup>-4</sup> (0.24)	0.0431×10 <sup>-4</sup> (0.24)	0.0433×10 <sup>-4</sup> (0.24)	0.0436×10 <sup>-4</sup> (0.24)
Permissible Load Inertia*3	J: kg·m <sup>2</sup> (oz·in <sup>2</sup> )	0.0022 (120)	0.0087 (470)	0.054 (3000)	0.0036 (197)	0.0415 (2300)	0.091 (5000)
Gear Ratio		5	10	25	5	10	25
Resolution*4	P/R	100 to 100000 (Factory setting 1000)					
Detector		Absolute Encoder 1 rotation 20 bits, multiple rotations 16 bits					
Backlash	arc minutes (degrees)	15 (0.25)					
Power-Supply Input	Voltage and Frequency	AC Main Power Supply					
		Single-Phase 100-115 VAC -15 to +10% 50/60 Hz Single-Phase 200-230 VAC -15 to +10% 50/60 Hz Three-Phase 200-230 VAC -15 to +10% 50/60 Hz					
	Rated Input Current*5 A	DC Control Power Supply					
		24 VDC±10% 0.8 A					
Single-Phase 100-115 VAC		1.9			2.9		
Single-Phase 200-230 VAC	1.2			1.8			
Three-Phase 200-230 VAC	0.7			1.0			
Electromagnetic Brake*6	Type	Power Off Activated Type					
	Power-Supply Input	24 VDC±10%					
	Power Consumption	W 6.1					
	Excitation Current	A 0.25					
Static Friction Torque	N·m (lb·in)	0.716 (6.3)	1.43 (12.6)	3.22 (28)	1.43 (12.6)	2.86 (25)	6.44 (56)

\*1 The brackets [ ] indicate the value for the electromagnetic brake type.

\*2 The gearhead internal inertia is the motor shaft converted value.

\*3 The value for 50 times the rotor inertia.

\*4 The resolution for the motor output shaft.

\*5 These values are for operation in the continuous duty region. For operation in the limited duty region, the maximum current is approximately 3 times the value shown.

\*6 The electromagnetic brake is for holding the position when the power supply is OFF. The electromagnetic brake cannot be used to stop the motor. A separate power supply for the electromagnetic brake is also required.

### Speed – Torque Characteristics

NX65□-PS5-3

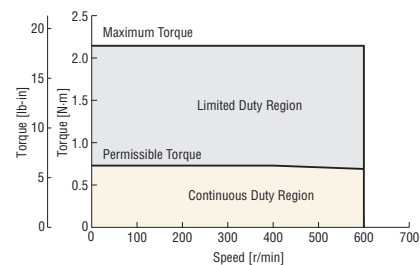

NX65□-PS10-3

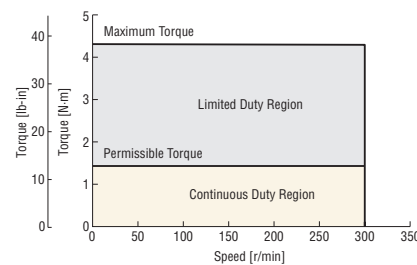

NX65□-PS25-3

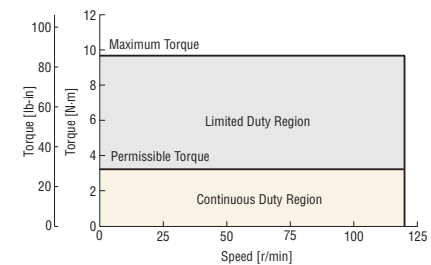

NX610□-PS5-3

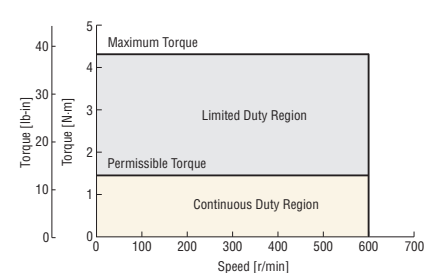

NX610□-PS10-3

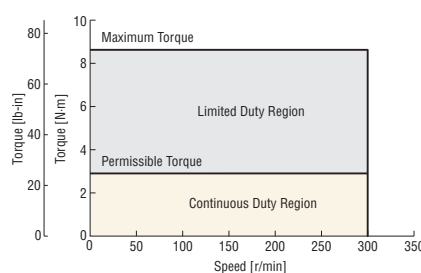

NX610□-PS25-3

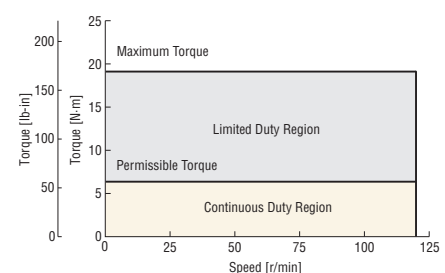

● Either **A** (standard) or **M** (electromagnetic brake type) indicating the motor configuration is entered where the box (□) is located within the product name.

● Either **A** (single-phase 100-115 VAC) or **C** (single-phase 200-230 VAC/three-phase 200-230 VAC) indicating the power supply voltage is entered where the box (□) is located within the product name.

● Depending on the operating conditions, a regeneration unit may be required. Regeneration Unit → Page B-57

# PS Geared Type Frame Size 90 mm (3.54 in.)

## Specifications RoHS

● UL/CSA standards pending CE

Model	Standard	NX920A□-PS5-3	NX920A□-PS10-3	NX920A□-PS25-3	NX940AS-PS5-3	NX940AS-PS10-3	NX940AS-PS25-3
	Electromagnetic Brake Type	NX920M□-PS5-3	NX920M□-PS10-3	NX920M□-PS25-3	NX940MS-PS5-3	NX940MS-PS10-3	NX940MS-PS25-3
Rated Output Power	W (HP)	200 (1/4)			400 (1/2)		
Motor Permissible Speed	r/min	3000					
Permissible Torque	N·m (lb·in)	2.87 (25)	5.73 (50)	12.9 (114)	5.72 (50)	11.4 (100)	25.7 (220)
Maximum Torque	N·m (lb·in)	8.6 (76)	17.2 (152)	38.7 (340)	17.1 (151)	34.3 (300)	77.2 (680)
Permissible Speed Range	r/min	0 to 600	0 to 300	0 to 120	0 to 600	0 to 300	0 to 120
Rotor Inertia	J: kg·m <sup>2</sup> (oz·in <sup>2</sup> )	0.162×10 <sup>-4</sup> (0.89) [0.185×10 <sup>-4</sup> (1.01)]*1			0.291×10 <sup>-4</sup> (1.59) [0.314×10 <sup>-4</sup> (1.72)]*1		
Gearhead Internal Inertia*2	J: kg·m <sup>2</sup> (oz·in <sup>2</sup> )	0.163×10 <sup>-4</sup> (0.89)	0.160×10 <sup>-4</sup> (0.88)	0.175×10 <sup>-4</sup> (0.96)	0.163×10 <sup>-4</sup> (0.89)	0.160×10 <sup>-4</sup> (0.88)	0.175×10 <sup>-4</sup> (0.96)
Permissible Load Inertia*3	J: kg·m <sup>2</sup> (oz·in <sup>2</sup> )	0.02 (1090)	0.081 (4400)	0.51 (28000)	0.036 (1970)	0.146 (8000)	0.91 (50000)
Gear Ratio		5	10	25	5	10	25
Resolution*4	P/R	100 to 100000 (Factory setting 1000)					
Detector		Absolute Encoder 1 rotation 20 bits, multiple rotations 16 bits					
Backlash	arc minutes (degrees)	15 (0.25)					
Power-Supply Input	Voltage and Frequency	AC Main Power Supply Single-Phase 100-115 VAC -15 to +10% 50/60 Hz Single-Phase 200-230 VAC -15 to +10% 50/60 Hz Three-Phase 200-230 VAC -15 to +10% 50/60 Hz			Three-Phase 200-230 VAC -15% to +10% 50/60 Hz		
	DC Control Power Supply	24 VDC±10% 0.8 A					
	Rated Input Current*5 A	Single-Phase 100-115 VAC	4.6				–
	Three-Phase 200-230 VAC	1.6				2.8	
Electromagnetic Brake*6	Type	Power Off Activated Type					
	Power-Supply Input	24 VDC±10%					
	Power Consumption	7.2					
	Excitation Current	0.3					
Static Friction Torque	N·m (lb·in)	2.87 (25)	5.73 (50)	12.9 (114)	5.72 (50)	11.4 (100)	25.7 (220)

\*1 The brackets [ ] indicate the specifications for the electromagnetic brake type.

\*2 The gearhead internal inertia is the motor shaft converted value.

\*3 The value for 50 times the rotor inertia.

\*4 The resolution for the motor output shaft.

\*5 These values are for operation in the continuous duty region. For operation in the limited duty region, the maximum current is approximately 3 times the value shown.

\*6 The electromagnetic brake is for holding the position when the power supply is OFF. The electromagnetic brake cannot be used to stop the motor. A separate power supply for the electromagnetic brake is also required.

## Speed – Torque Characteristics

NX920□-PS5-3

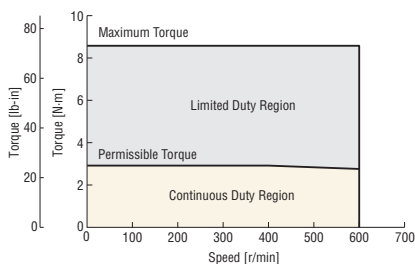

NX920□-PS10-3

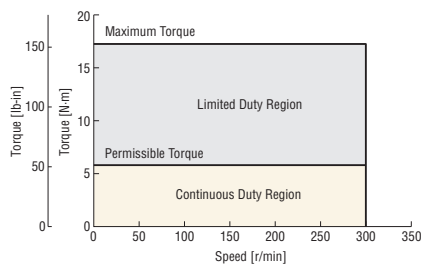

NX920□-PS25-3

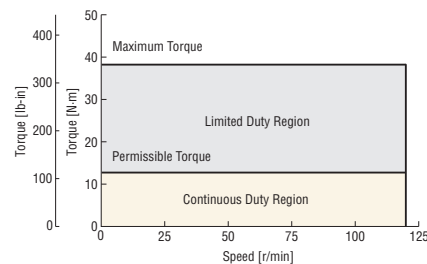

NX940□S-PS5-3

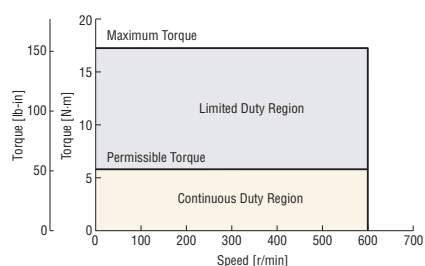

NX940□S-PS10-3

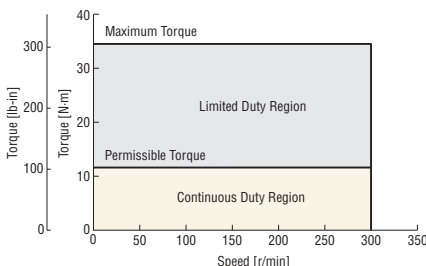

NX940□S-PS25-3

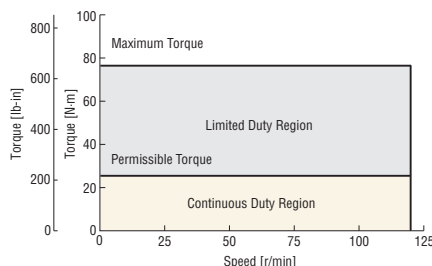

● Either **A** (standard) or **M** (electromagnetic brake type) indicating the motor configuration is entered where the box (□) is located within the product name.

Either **A** (single-phase 100-115 VAC) or **C** (single-phase 200-230 VAC/three-phase 200-230 VAC) indicating the power supply voltage is entered where the box (□) is located within the product name.

● Depending on the operating conditions, a regeneration unit may be required. Regeneration Unit → Page B-57

## PJ Geared Type Frame Size 104 mm (4.09 in.)

### Specifications RoHS

● UL/CSA standards pending CE

Model	Standard Electromagnetic Brake Type	<b>NX1075AS-J5-3</b>		<b>NX1075AS-J10-3</b>		<b>NX1075AS-J25-3</b>	
		<b>NX1075MS-J5-3</b>		<b>NX1075MS-J10-3</b>		<b>NX1075MS-J25-3</b>	
Rated Output Power	W (HP)			750 (1)			
Motor Permissible Speed	r/min			3000			
Permissible Torque	N·m (lb-in)	9.56 (84)		19.1 (169)		47.8 (420)	
Maximum Torque	N·m (lb-in)	28.7 (250)		57.3 (500)		143 (1260)	
Permissible Speed Range	r/min	0 to 600		0 to 300		0 to 120	
Rotor Inertia	J: kg·m <sup>2</sup> (oz-in <sup>2</sup> )			0.941×10 <sup>-4</sup> (5.1) [1.02×10 <sup>-4</sup> (5.6)]*1			
Gearhead Internal Inertia*2	J: kg·m <sup>2</sup> (oz-in <sup>2</sup> )	1.31×10 <sup>-4</sup> (7.2)		0.888×10 <sup>-4</sup> (4.9)		0.832×10 <sup>-4</sup> (4.6)	
Permissible Load Inertia*3	J: kg·m <sup>2</sup> (oz-in <sup>2</sup> )	1180×10 <sup>-4</sup> (6500)		4710×10 <sup>-4</sup> (26000)		29400×10 <sup>-4</sup> (161000)	
Gear Ratio		5		10		25	
Resolution*4	P/R	100 to 100000 (Factory setting 1000)					
Detector		Absolute Encoder 1 rotation 20 bits, multiple rotations 16 bits					
Backlash	arc minutes (degrees)	3 (0.05)					
Power-Supply Input	Voltage and Frequency	AC Main Power Supply		Three-Phase 200-230 VAC -15% to +10% 50/60 Hz			
		DC Control Power Supply		24 VDC±10% 0.8 A			
	Rated Input Current*5 A	Three-Phase 200-230 VAC		4.7			
Electromagnetic Brake*6	Type	Power Off Activated Type					
	Power-Supply Input	24 VDC±10%					
	Power Consumption W	8.5					
	Excitation Current A	0.35					
	Static Friction Torque N·m (lb-in)	9.56 (84)		19.1 (169)		47.8 (420)	

\*1 The brackets [ ] indicate the specifications for the electromagnetic brake type.

\*2 The gearhead internal inertia is the motor shaft converted value.

\*3 The value for 50 times the rotor inertia.

\*4 The resolution for the motor output shaft.

\*5 These values are for operation in the continuous duty region. For operation in the limited duty region, the maximum current is approximately 3 times the value shown.

\*6 The electromagnetic brake is for holding the position when the power supply is OFF. The electromagnetic brake cannot be used to stop the motor. A separate power supply for the electromagnetic brake is also required.

### Speed – Torque Characteristics

**NX1075□S-J5-3**

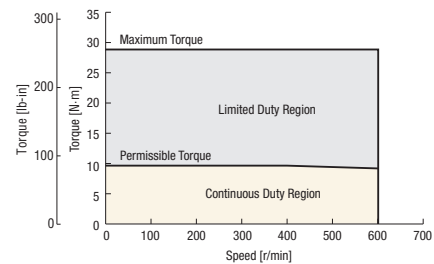

**NX1075□S-J10-3**

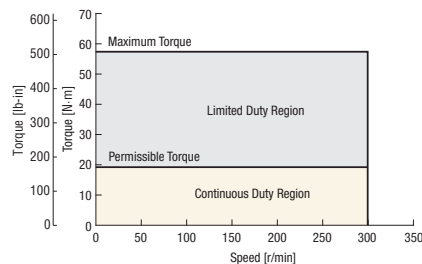

**NX1075□S-J25-3**

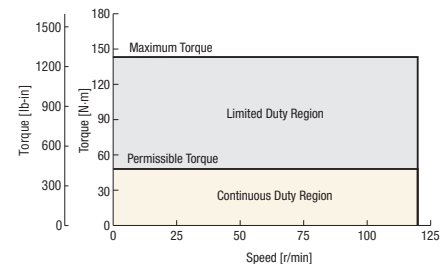

● Either **A** (standard) or **M** (electromagnetic brake type) indicating the motor configuration is entered where the box (□) is located within the product name.

● Depending on the driving conditions, a regeneration unit may be required. Regeneration Unit → Page B-57

## Driver Specifications

Interface	Pulse, Analog Speed Command Voltage, Analog Torque Command Voltage
Max. Input Pulse Frequency	Line driver output: 500 kHz (When the pulse duty is 50%) Open collector output: 250 kHz (When the pulse duty is 50%)*
Protective Function	When the following protective functions are activated, an alarm output signal is output and the motor is stopped. Overflow, Overcurrent Protection, Overheat Protection, Overvoltage Protection, Main Power Supply Error, Undervoltage, Motor Overheat Protection, Sensor Error during Operation, Encoder Communication Error, Overload, Overspeed, Position Range Error, Absolute Position Loss, Command Pulse Error, EEPROM Error, Sensor Error during Initialization, Rotor Rotation during Initialization, Encoder EEPROM Error, Motor Combination Error, ABS Not Supported, No Battery, Regeneration Unit Overheat, Electronic Gear Setting Error
Input Signal	<ul style="list-style-type: none"> <li>• Photocoupler Input, Input Resistance: 3 k<math>\Omega</math> Input Signal Voltage: 4.75 to 26.4 VDC (S-ON, CLR/ALM-RST/P-CK, P-REQ/BRAKE, TL/W-RESET, M0, M1, P-PRESET/M2, FREE)</li> <li>• Photocoupler Input, Input Resistance: 2.7 k<math>\Omega</math> Input Voltage: 21.6 to 26.4 VDC (PLS+24 V/CW+24 V, DIR+24 V/CCW+24 V)</li> <li>• Photocoupler Input, Input Resistance: 200 <math>\Omega</math> Input Voltage: 3 to 5.25 VDC (PLS/CW, DIR/CCW)</li> <li>• Analog Input</li> </ul> Set with Internal Potentiometer (VR1, VR2) Analog Input Voltage $\pm 10$ VDC Input Impedance 15 k $\Omega$ Set with External Potentiometer 20 k $\Omega$ 1/4 W (V-REF, T-REF, P-VREF, P-TREF)
Output Signal	<ul style="list-style-type: none"> <li>• Photocoupler and Open Collector Output External use conditions: 30 VDC, 10 mA max. (ALM, WNG/MOVE/MBC, END/VA, READY/AL0/P-OUTR, TLC/VLC/AL1/P-OUT0, ZSG2/NEAR/ZV/AL2/P-OUT1)</li> <li>• Line Driver Output</li> </ul> External use condition: Connect a terminating resistor of 100 $\Omega$ min. between the line receiver inputs. (ASG, BSG, ZSG1) <ul style="list-style-type: none"> <li>• Analog Monitor Output Analog Output Voltage <math>\pm 10</math> VDC Output Impedance 1 k<math>\Omega</math> (V-MON, T-MON, SG)</li> </ul>
Other Functions	Position Control, Speed Control, Torque Control, Tension Control Automatic Tuning, Damping Control Function (7 to 30 Hz), Position Preset Function, Current Position Output Function, Torque Limiting Function Pulse Input Mode (2-Pulse Input, 1-Pulse Input), Analog Monitor Output Function (Speed, Torque), Absolute System Enabled/Disabled Warning Output Function, (Overflow, Overheat, Overvoltage, Main Power Supply, Undervoltage, Battery Undervoltage, Overload, Overspeed, Absolute Position Loss, Electronic Gear Setting Error)
Extended Functions [When using the separately-sold control module ( <b>OPX-2A</b> ) or the data setting software ( <b>MEXE02</b> )]	For details on extended functions, refer to page B-43.

\*The values when the separately-sold general-purpose cable (**CC36D1-1**) is used. General-Purpose Cable → Page B-51

## Position Control Mode Specifications

Item	Factory Setting	When Using Extended Functions
Command Mode	Pulse Input Mode, Select one of the following: <ul style="list-style-type: none"> <li>2-Pulse Input Mode</li> <li>1-Pulse Input Mode (Factory setting)</li> </ul>	Pulse Input Mode, Select one of the following: <ul style="list-style-type: none"> <li>2-Pulse Input Mode</li> <li>1-Pulse Input Mode</li> <li>Phase Difference Input Mode (Internal parameter setting)</li> </ul>
Max. Input Pulse Frequency	Line driver output by programmable controller: 500 kHz (When the pulse duty is 50%) Open collector output by programmable controller: 250 kHz (When the pulse duty is 50%)*1	
Resolution	1000 P/R	100 to 100000 P/R
Encoder Output Resolution	1000 P/R	100 to 10000 P/R
Damping Control Frequency	One type of frequency can be established: <ul style="list-style-type: none"> <li>Internal potentiometer VR1 (potentiometer) - one product line Disabled/7-30 Hz (internal potentiometer VR1)</li> </ul>	Four types of frequencies can be established in the following two ways: <ul style="list-style-type: none"> <li>Combination of one type of internal potentiometer VR1 (potentiometer) and three types of internal parameters</li> <li>Four types of internal parameters Disabled/7-30 Hz (internal potentiometer VR1) Disabled/7-100 Hz (internal parameters established)</li> </ul>
Absolute System Position Control Range	-2 147 483 648 to 2 147 483 647 pulses	
Current Position Output	2-bit Serial Output	
Tuning	Automatic tuning only <Automatic> The rigidity setting (SW2) is selected from 16 levels. The load inertia is estimated and the gain is automatically adjusted according to the rigidity setting.	Automatic tuning, semi-auto tuning, and manual tuning can be selected. <Automatic> Select the rigidity setting (SW2 or internal parameter) from 16 levels. The load inertia is estimated and the gain is automatically adjusted according to the rigidity setting. <Semi-Auto> Select the rigidity setting (SW2 or internal parameter) from 16 levels. Input the load inertia ratio. <Manual> Select the rigidity setting (SW2 or internal parameter) from 16 levels. Input the load inertia ratio. All gain can be set manually.
Torque Limiting	0 to 300% (The rated torque is 100%.) External Potentiometer*2 (T-REF)	0 to 300% (The rated torque is 100%. Can be set in steps of 1% with an internal parameter.) Set with External Potentiometer*2 (T-REF), Internal Parameter

● Using extended functions requires the separately-sold control module (**OPX-2A**) or the data setting software (**MEXE02**).

\*1 The values when the separately-sold general-purpose cable (**CC36D1-1**) is used. General-Purpose Cable → Page B-51

\*2 Accessory sets are available (sold separately). Accessory Set → Page B-56

## Speed Control Mode Specifications

Item	Factory Setting	When Using Extended Functions
Command Mode	<p>Two types of speeds can be established:</p> <ul style="list-style-type: none"> <li>● Internal potentiometer VR1 (potentiometer) - one speed</li> <li>● External potentiometer V-REF (potentiometer or external DC voltage selected) - one speed</li> </ul> <p>[External potentiometer* V-REF (potentiometer or external DC voltage selected)]</p> <ul style="list-style-type: none"> <li>· Set using potentiometer: 20 kΩ 1/4 W</li> <li>· Set using external DC voltage: ±0 to 10 VDC Input impedance 15 kΩ</li> </ul>	<p>Eight types of speeds can be established in the following two ways:</p> <ul style="list-style-type: none"> <li>● Combination of one speed of internal potentiometer VR1 (potentiometer), one speed of external potentiometer V-REF (potentiometer or external DC voltage selected), and six internal parameter speeds</li> <li>● Eight internal parameter speeds</li> </ul> <p>[External potentiometer* V-REF (potentiometer or external DC voltage selected)]</p> <ul style="list-style-type: none"> <li>· Set using potentiometer: 20 kΩ 1/4 W</li> <li>· Set using external DC voltage: ±0 to 10 VDC Input impedance 15 kΩ</li> </ul>
Speed Setting Range	10 to 5500 r/min (Analog speed setting VR1, V-REF)	10 to 5500 r/min (Analog speed setting VR1, V-REF) 1 to 5500 r/min (Internal parameter setting)
Acceleration/Deceleration Time Setting Range	5 ms to 10 sec./(1000 r/min) (Acceleration and deceleration time per 1000 r/min) Internal Potentiometer (VR2)	5 ms to 10 sec./(1000 r/min) (Acceleration and deceleration time per 1000 r/min) The setting method can be selected: either an internal potentiometer (VR2) or internal parameter.
Speed Regulation	Load	±0.05% max. (0 to rated torque, rated speed, rated voltage, normal temperature)
	Voltage	±0.05% max. (Power-supply input voltage range, at 3000 r/min no load)
	Temperature	±0.5% max. (With analog speed setting VR1, V-REF) Common Conditions Operating Ambient Temperature 0 to +50°C, Rated Speed, No Load, Rated Voltage
Torque Limiting	0 to 300% (100% is rated torque.) Set with External Potentiometer* (T-REF)	0 to 300% (100% is rated torque. Can be set in steps of 1% with an internal parameter.) Set with External Potentiometer* (T-REF), Internal Parameter
Operation When Motor is Stopped	—	The operation when the motor is stopped can be selected <ul style="list-style-type: none"> <li>· Motor Non-Excitation</li> <li>· Position Holding by Servo Control Stopped (Motor excitation)</li> </ul>
Tuning	<p>Automatic tuning only</p> <p>&lt;Automatic&gt; The rigidity setting (SW2) is selected from 16 levels. The load inertia is estimated and the gain is automatically adjusted according to the rigidity setting.</p>	<p>Automatic tuning, semi-auto tuning and manual tuning can be selected. When operation when the motor is stopped is set to "Position holding by servo control stopped", the position loop gain and speed feed-forward are set just like position control.</p> <p>&lt;Automatic&gt; Select the rigidity setting (SW2 or internal parameter) from 16 levels. The load inertia is estimated and the gain is automatically adjusted according to the rigidity setting.</p> <p>&lt;Semi-Auto&gt; Select the rigidity setting (SW2 or internal parameter) from 16 levels. Input the load inertia ratio.</p> <p>&lt;Manual&gt; Select the rigidity setting (SW2 or internal parameter) from 16 levels. Input the load inertia ratio. All gain can be set manually.</p>
Encoder Output Resolution	1000 P/R	100 to 10000 P/R

● Using extended functions requires the separately-sold control module (**OPX-2A**) or the data setting software (**MEXE02**).

\* Accessory sets are available (sold separately). Accessory Set → Page B-56

## Torque Control Mode Specifications

Item	Factory Setting	When Using Extended Functions
Command Mode	<p>Two types of torque can be established:</p> <ul style="list-style-type: none"> <li>● Internal potentiometer VR1 (potentiometer) - one type</li> <li>● External potentiometer T-REF (potentiometer or external DC voltage selected) - one type</li> </ul> <p>[External potentiometer* T-REF (potentiometer or external DC voltage selected)]</p> <ul style="list-style-type: none"> <li>· Set using potentiometer: 20 kΩ 1/4 W</li> <li>· Set using external DC voltage: ±0 to 10 VDC Input impedance 15 kΩ</li> </ul>	<p>Eight types of torque can be established in the following two ways:</p> <ul style="list-style-type: none"> <li>● Combination of one type of internal potentiometer VR1 (potentiometer), one type of external potentiometer T-REF (potentiometer or external DC voltage selected), and six types of internal parameters</li> <li>● Eight types of internal parameters</li> </ul> <p>[External potentiometer* T-REF (potentiometer or external DC voltage selected)]</p> <ul style="list-style-type: none"> <li>· Set using potentiometer: 20 kΩ 1/4 W</li> <li>· Set using external DC voltage: ±0 to 10 VDC Input impedance 15 kΩ</li> </ul>
Torque Control Range	0 to 300% (100% is rated torque.)	0 to 300% (100% is rated torque. Can be set in steps of 1% with an internal parameter.)
Speed Limit	0 to 5500 r/min Set with internal potentiometer (VR2) or external potentiometer* (V-REF)	0 to 5500 r/min (Can be set in 1 r/min steps with an internal parameter.) Set with internal potentiometer (VR2) or external potentiometer* (V-REF), or with an internal parameter
Encoder Output Resolution	1000 P/R	100 to 10000 P/R

● Using extended functions requires the separately-sold control module (**OPX-2A**) or the data setting software (**MEXE02**).

\* Accessory sets are available (sold separately). Accessory Set → Page B-56

## Tension Control Mode Specifications

Item	Factory Setting	When Using Extended Functions
Command Mode	Two types of tension can be established: <ul style="list-style-type: none"> <li>● Internal potentiometer VR1 (potentiometer) - one type</li> <li>● External potentiometer T-REF (potentiometer or external DC voltage selected) - one type</li> </ul> [External potentiometer* T-REF (potentiometer or external DC voltage selected)] <ul style="list-style-type: none"> <li>· Set using potentiometer: 20 kΩ 1/4 W</li> <li>· Set using external DC voltage: ±0 to 10 VDC Input impedance 15 kΩ</li> </ul>	Eight types of tension can be established in the following two ways: <ul style="list-style-type: none"> <li>● Combination of one type of internal potentiometer VR1 (potentiometer), one type of external potentiometer T-REF (potentiometer or external DC voltage selected), and six types of internal parameters</li> <li>● Eight types of internal parameters</li> </ul> [External potentiometer* T-REF (potentiometer or external DC voltage selected)] <ul style="list-style-type: none"> <li>· Set using potentiometer: 20 kΩ 1/4 W</li> <li>· Set using external DC voltage: ±0 to 10 VDC Input impedance 15 kΩ</li> </ul>
Control Method	Simple Mode	The tension is controlled to be constant when the feed speed is constant.
	High Function Mode I	—
	High Function Mode II	—
Tension Control Range	0 to 100% (100% is rated torque.)	0 to 100% (100% is rated torque. Can be set in steps of 1%.)
Speed Limit	0 to 5500 r/min Set with internal potentiometer (VR2), external potentiometer* (V-REF)	0 to 5500 r/min (Can be set in 1 r/min steps.) Set with internal potentiometer (VR2) or external potentiometer* (V-REF), or with an internal parameter
Minimum Speed	The minimum speed for simple mode can be selected with SW2. The setting range has 16 levels from 0 (10 r/min) to F (3000 r/min).	
Encoder Output Resolution	1000 P/R	100 to 10000 P/R

● Using extended functions requires the separately-sold control module (**OPX-2A**) or the data setting software (**MEXE02**).

\* Accessory sets are available (sold separately). Accessory Set → Page B-56

## General Specifications

Specifications	Motor	Driver
Thermal Class	130 (B)	—
Insulation Resistance	100 MΩ min. when measured with a 500 VDC megger between the following locations: <ul style="list-style-type: none"> <li>· Case — Motor Windings</li> <li>· Case — Electromagnetic Brake Windings</li> </ul>	100 MΩ min. when measured with a 500 VDC megger between the following locations: <ul style="list-style-type: none"> <li>· PE terminal — AC Main Power Supply Connector, Motor Connector</li> <li>· DC Control Power Supply Connector, I/O Connector, Encoder Connector, Control Module Connector, Battery Connector</li> <li>— AC Main Power Supply Connector, Motor Connector</li> </ul>
Dielectric Voltage	No abnormality is judged with the following application for 1 minute: <ul style="list-style-type: none"> <li>· Case — Motor Windings 1.5 kVAC 50 Hz or 60 Hz</li> <li>· Case — Electromagnetic Brake Windings 1.0 kVAC 50 Hz or 60 Hz</li> </ul>	No abnormality is judged with the following application for 1 minute: <ul style="list-style-type: none"> <li>· PE terminal — AC Main Power Supply Connector, Motor Connector 1.5 kVAC 50 Hz or 60 Hz</li> <li>· DC Control Power Supply Connector, I/O Connector, Encoder Connector, Control Module Connector, Battery Connector</li> <li>— AC Main Power Supply Connector, Motor Connector 1.8 kVAC 50 Hz or 60 Hz</li> </ul>
Operating Environment (In operation)	Ambient Temperature	0 to +40°C (+32 to +104°F) (Non-freezing)
	Ambient Humidity	85% max. (Non-condensing)
	Atmosphere	No corrosive gases. Must not be exposed to oil or other liquids.
Degree of Protection	IP65 (Standard type, electromagnetic brake type, <b>PS</b> geared type: excluding installation surface and connector locations. <b>PJ</b> geared type: excluding connector locations)	IP20
Shaft Runout	0.05 mm (0.002 in.) T. I. R.*1	—
Concentricity of Installation Pilot to the Shaft	0.075 mm (0.003 in.) T. I. R.*1	—
Perpendicularity of Installation Surface to the Shaft	0.075 mm (0.003 in.) T. I. R.*1	—

\*1 T. I. R. (Total Indicator Reading): The total dial gauge reading when the measurement section is rotated 1 rotation centered on the reference axis.

\*2 If the driver's ambient temperature exceeds 40°C (104°F), hold the continuous motor output below the derating curve in the figure below.

### Note

● Do not perform the insulation resistance test or dielectric voltage withstand test while the motor and driver are connected.  
Also, do not conduct these tests on the motor encoder section.

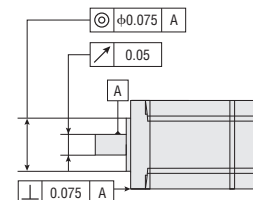

● Motor Continuous Output Derating Curve

If the driver's operating ambient temperature exceeds 40°C (104°F), hold the continuous motor output below the derating curve in the figure below. There is no need for derating for the types with rated output power of 50 W (1/15 HP) or 400 W (1/2 HP).

◇ Rated Output Power 100 W (1/8 HP)

◇ Rated Output Power 200 W (1/4 HP)

◇ Rated Output Power 750 W (1 HP)

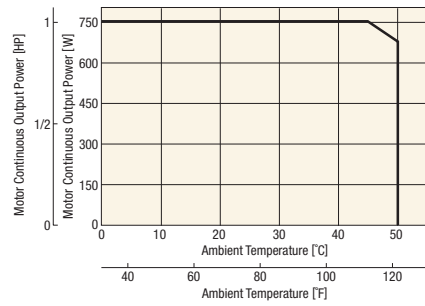
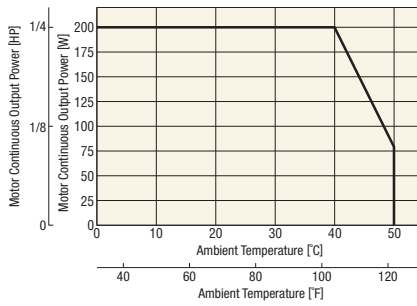
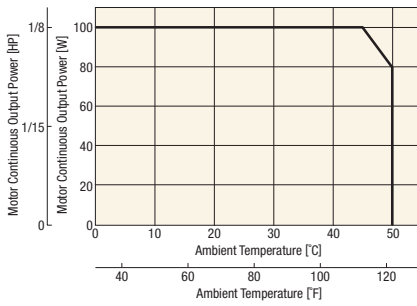

■ Permissible Overhung Load, Permissible Thrust Load and Permissible Moment Load

Type	Frame Size [mm (in.)]	Type	Gear Ratio	Permissible Overhung Load [N (lb.)]									Permissible Thrust Load [N (lb.)]	Permissible Moment Load [N·m (lb-in)]
				Distance from Shaft End [mm (in.)]										
				0 (0)	5 (0.2)	10 (0.39)	15 (0.59)	20 (0.79)	25 (0.98)	30 (1.18)	35 (1.38)			
Standard Type	42 (1.65)	<b>NX45</b> <b>NX410</b>	-	81 (18.2)	88 (19.8)	95 (21)	104 (23)	-	-	-	-	59 (13.2)	-	
	60 (2.36)	<b>NX620</b> <b>NX640</b>		230 (51)	245 (55)	262 (58)	281 (63)	304 (68)	-	-	-	98 (22)	-	
	85 (3.35)	<b>NX975</b>		376 (84)	392 (88)	408 (91)	426 (95)	446 (100)	467 (105)	491 (110)	-	147 (33)	-	
PS Geared Type	60 (2.36)	<b>NX65</b> <b>NX610</b>	5	200 (45)	220 (49)	250 (56)	280 (63)	320 (72)	-	-	-	100 (22)	-	
			10	250 (56)	270 (60)	300 (67)	340 (76)	390 (87)	-	-	-		-	
			25	330 (74)	360 (81)	400 (90)	450 (101)	520 (117)	-	-	-		-	
	90 (3.54)	<b>NX920</b> <b>NX940</b>	5, 10	480 (108)	540 (121)	600 (135)	680 (153)	790 (177)	-	-	-	300 (67)	-	
			25	850 (191)	940 (210)	1050 (230)	1190 (260)	1380 (310)	-	-	-		-	
PJ Geared Type	104 (4.09)	<b>NX1075</b>	5	650 (146)	700 (157)	730 (164)	750 (168)	800 (180)	830 (186)	880 (198)	920 (200)	500 (112)	30 (260)	
			10	900 (200)	950 (210)	1000 (220)	1050 (230)	1100 (240)	1180 (260)	1230 (270)	1300 (290)	650 (146)	66 (580)	
			25	1350 (300)	1400 (310)	1480 (330)	1550 (340)	1600 (360)	1650 (370)	1750 (390)	1850 (410)	1000 (220)	120 (1060)	

■ PJ Geared Type Permissible Moment Load

When installing an arm or table on the flange face, if an eccentric load is applied, calculate the moment load with the following formula.

Moment load:  $M [N·m (lb-in)] = F \times L$

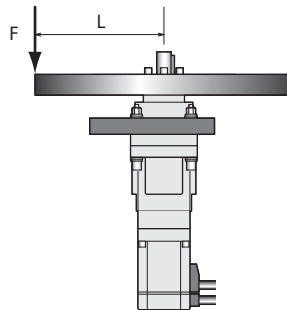



## Dimensions Unit = mm (in.)

### ● Motor

#### ◇ Standard Type

#### Motor Frame Size 42 mm (1.65 in.)

Model	Motor Model	L	Mass kg (lb.)	DXF
<b>NX45A</b> □-3	NXM45A	74.5 (2.93)	0.5 (1.1)	C210
<b>NX410A</b> □-3	NXM410A	88.8 (3.50)	0.6 (1.3)	C211

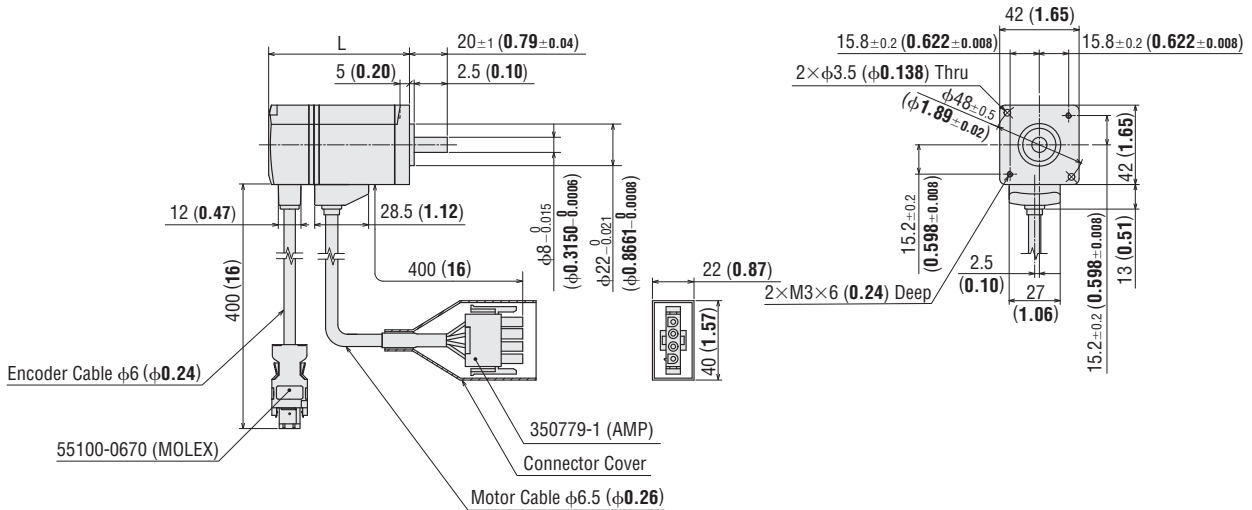

#### Motor Frame Size 42 mm (1.65 in.) Electromagnetic Brake Type

Model	Motor Model	L	Mass kg (lb.)	DXF
<b>NX45M</b> □-3	NXM45M	110.5 (4.35)	0.7 (1.5)	C212
<b>NX410M</b> □-3	NXM410M	124.8 (4.91)	0.8 (1.8)	C213

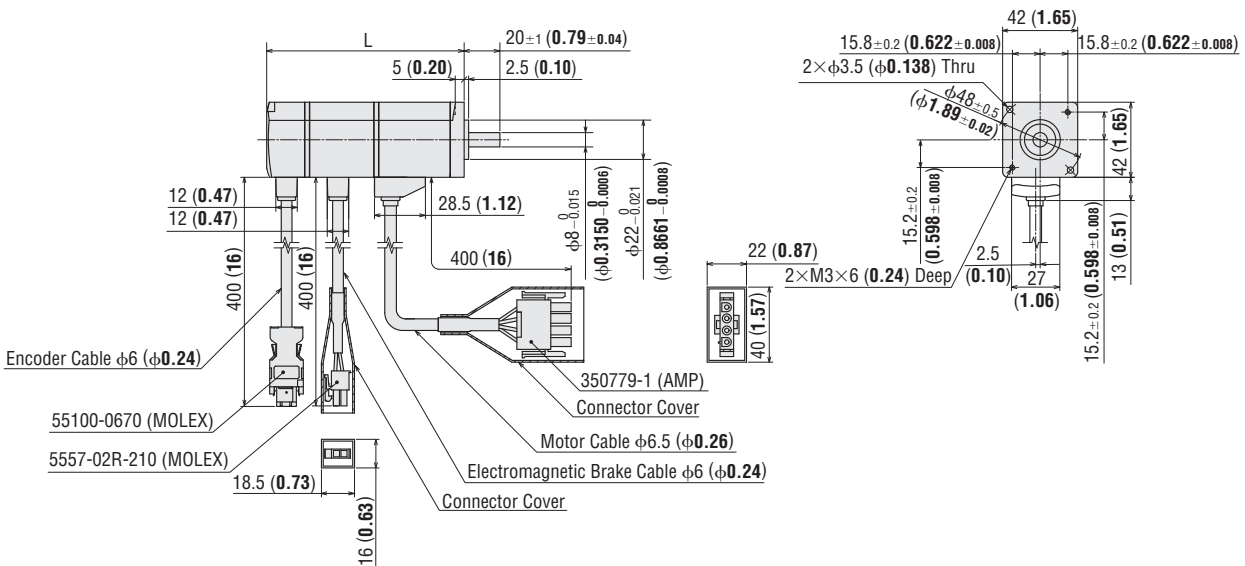

● Either **A** (single-phase 100-115 VAC) or **C** (single-phase 200-230 VAC/three-phase 200-230 VAC) indicating the power supply voltage is entered where the box (□) is located within the product name.

Motor Frame Size 60 mm (2.36 in.)

Model	Motor Model	L	Mass kg (lb.)	DXF
<b>NX620A-3</b>	NXM620A	84.5 (3.33)	1 (2.2)	C203
<b>NX640A-3</b>	NXM640A	114.8 (4.52)	1.5 (3.3)	C216

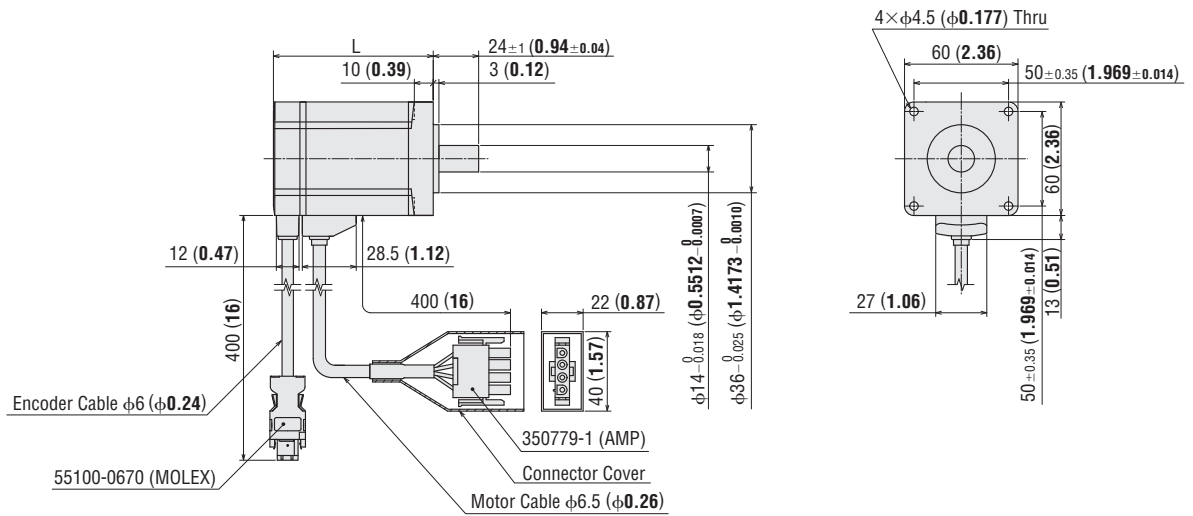

Motor Frame Size 60 mm (2.36 in.) Electromagnetic Brake Type

Model	Motor Model	L	Mass kg (lb.)	DXF
<b>NX620M-3</b>	NXM620M	126.3 (4.97)	1.5 (3.3)	C204
<b>NX640MS-3</b>	NXM640M	156.6 (6.17)	2 (4.4)	C217

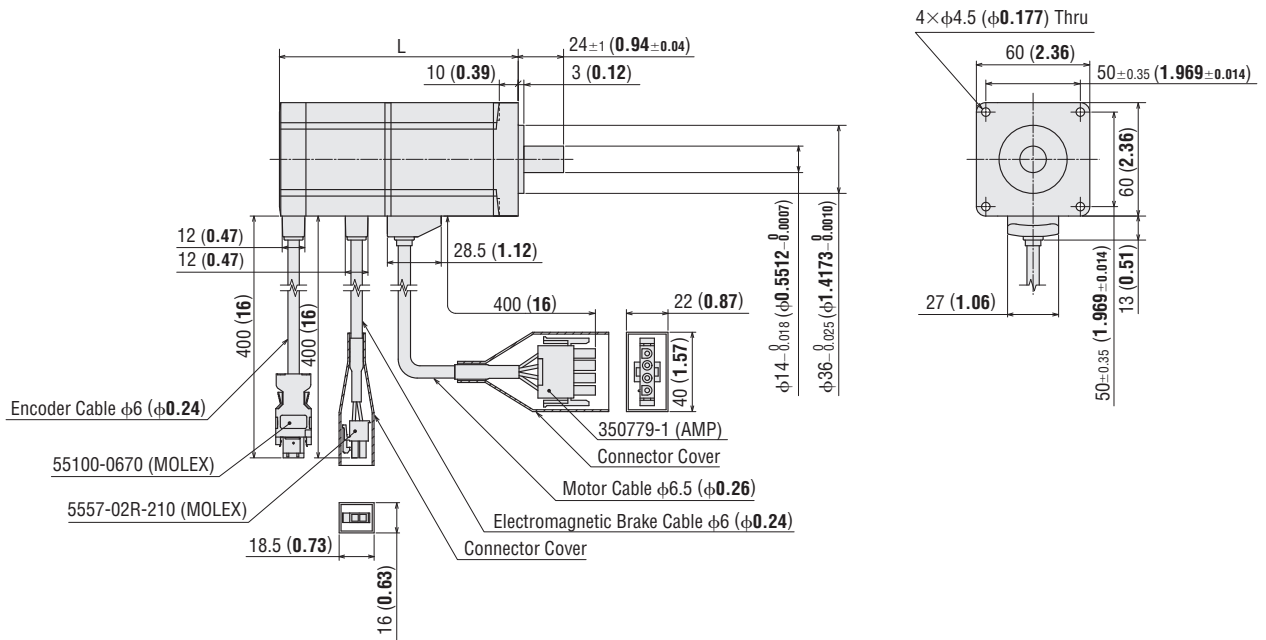

● Either **A** (single-phase 100-115 VAC) or **C** (single-phase 200-230 VAC/three-phase 200-230 VAC) indicating the power supply voltage is entered where the box (□) is located within the product name.

## Motor Frame Size 85 mm (3.35 in.)

Model	Motor Model	Mass kg (lb.)	DXF
<b>NX975AS-3</b>	NXM975A	3.1 (6.8)	C218

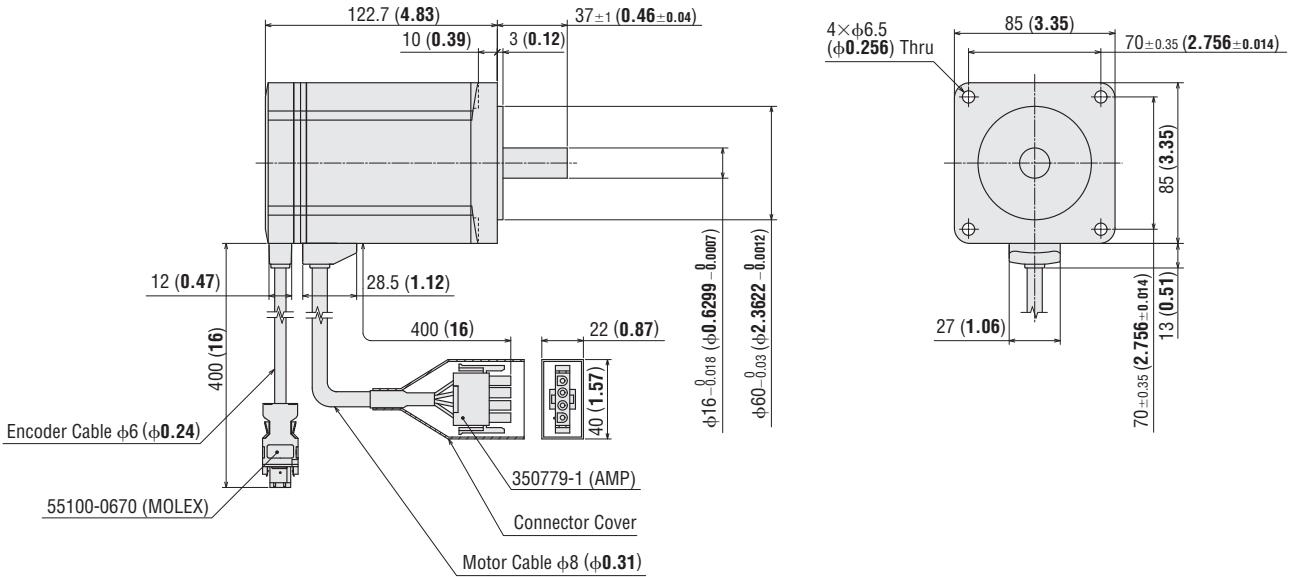

## Motor Frame Size 85 mm (3.35 in.) Electromagnetic Brake Type

Model	Motor Model	Mass kg (lb.)	DXF
<b>NX975MS-3</b>	NXM975M	4.1 (9.0)	C219

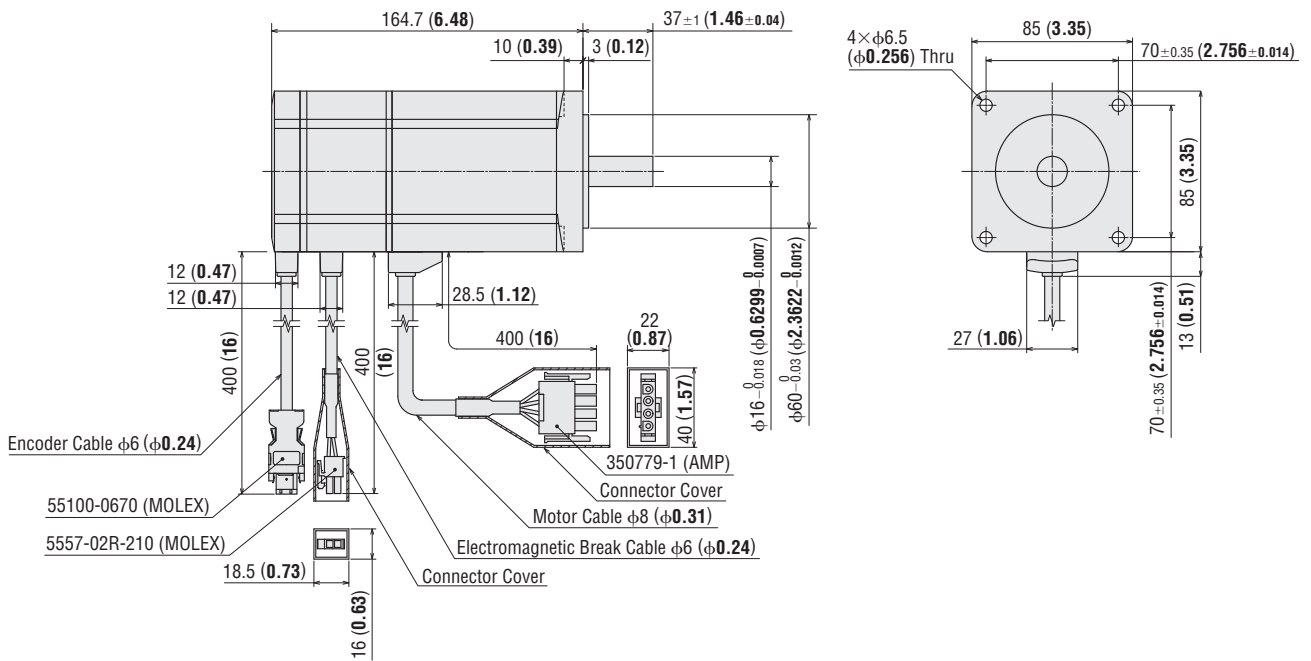

◇ PS Geared Type

Motor Frame Size 60 mm (2.36 in.)

Model	Motor Model	Gear Ratio	L1	L2	Mass kg (lb.)	DXF
NX65A □-PS □-3	NXM65A-PS □	5, 10	43 (1.69)	132.5 (5.22)	1.15 (2.5)	C241
		25	63.2 (2.49)	153 (6.02)	1.45 (3.2)	C242
NX610A □-PS □-3	NXM610A-PS □	5, 10	43 (1.69)	147 (5.79)	1.25 (2.8)	C243
		25	63.2 (2.49)	167 (6.57)	1.55 (3.4)	C244

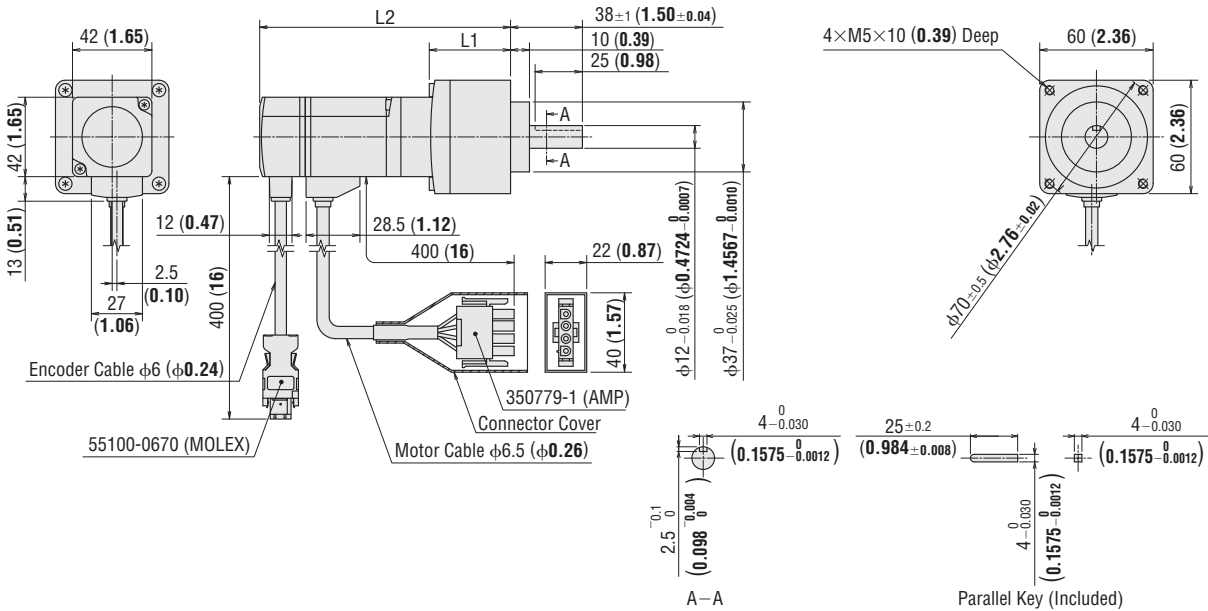

Motor Frame Size 60 mm (2.36 in.) Electromagnetic Brake Type

Model	Motor Model	Gear Ratio	L1	L2	Mass kg (lb.)	DXF
NX65M □-PS □-3	NXM65M-PS □	5, 10	43 (1.69)	168.5 (6.63)	1.35 (3.0)	C245
		25	63.2 (2.49)	189 (7.44)	1.65 (3.6)	C246
NX610M □-PS □-3	NXM610M-PS □	5, 10	43 (1.69)	183 (7.20)	1.45 (3.2)	C247
		25	63.2 (2.49)	203 (7.99)	1.75 (3.9)	C248

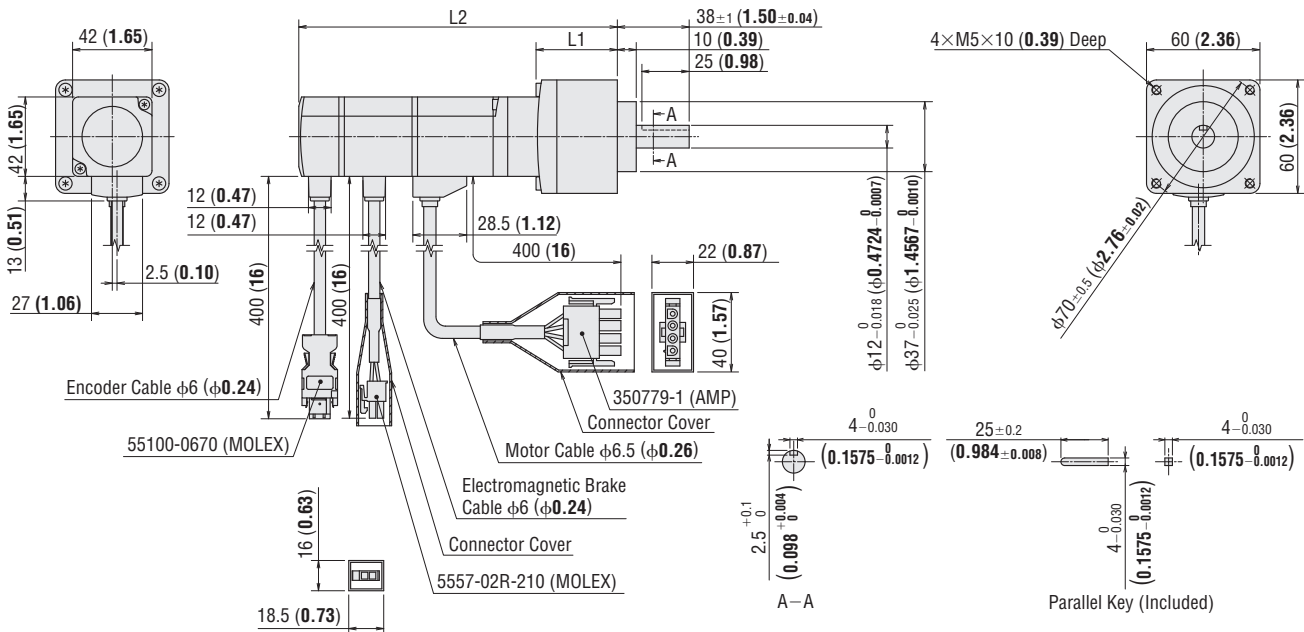

● Either **A** (single-phase 100-115 VAC) or **C** (single-phase 200-230 VAC/three-phase 200-230 VAC) indicating the power supply voltage is entered where the box (□) is located within the product name. A number indicating the gear ratio is entered where the box (□) is located within the product name.

## ◇ PS Geared Type

### Motor Frame Size 90 mm (3.54 in.)

Model	Motor Model	Gear Ratio	L1	L2	Mass kg (lb.)	DXF
<b>NX920A</b> <input type="checkbox"/> -PS <input type="checkbox"/> -3	NXM920A-PS <input type="checkbox"/>	<b>5, 10</b>	61 (2.40)	164.5 (6.48)	3.0 (6.6)	C249
		<b>25</b>	88.3 (3.48)	192 (7.65)	3.9 (8.6)	C250
<b>NX940AS</b> -PS <input type="checkbox"/> -3	NXM940A-PS <input type="checkbox"/>	<b>5, 10</b>	61 (2.40)	195 (7.68)	3.5 (7.7)	C251
		<b>25</b>	88.3 (3.48)	222 (8.74)	4.4 (9.7)	C252

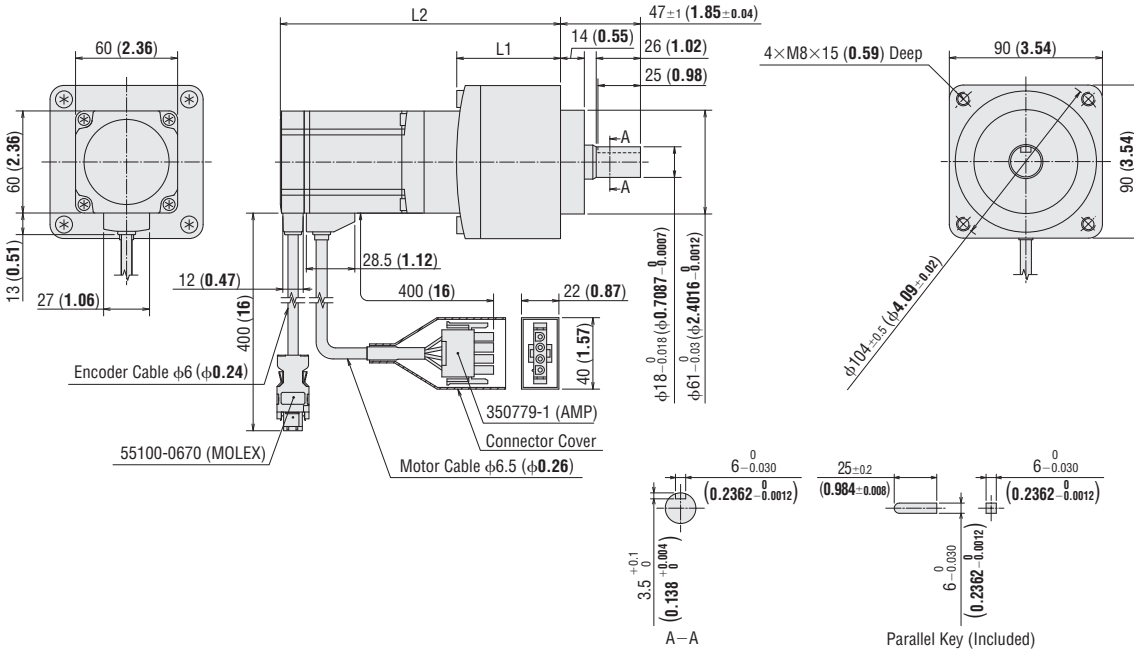

### Motor Frame Size 90 mm (3.54 in.) Electromagnetic Brake Type

Model	Motor Model	Gear Ratio	L1	L2	Mass kg (lb.)	DXF
<b>NX920M</b> <input type="checkbox"/> -PS <input type="checkbox"/> -3	NXM920M-PS <input type="checkbox"/>	<b>5, 10</b>	61 (2.40)	206.5 (8.13)	3.5 (7.7)	C253
		<b>25</b>	88.3 (3.48)	233.5 (9.19)	4.4 (9.7)	C254
<b>NX940MS</b> -PS <input type="checkbox"/> -3	NXM940M-PS <input type="checkbox"/>	<b>5, 10</b>	61 (2.40)	236.5 (9.31)	4.0 (8.8)	C255
		<b>25</b>	88.3 (3.48)	264 (10.39)	4.9 (10.8)	C256

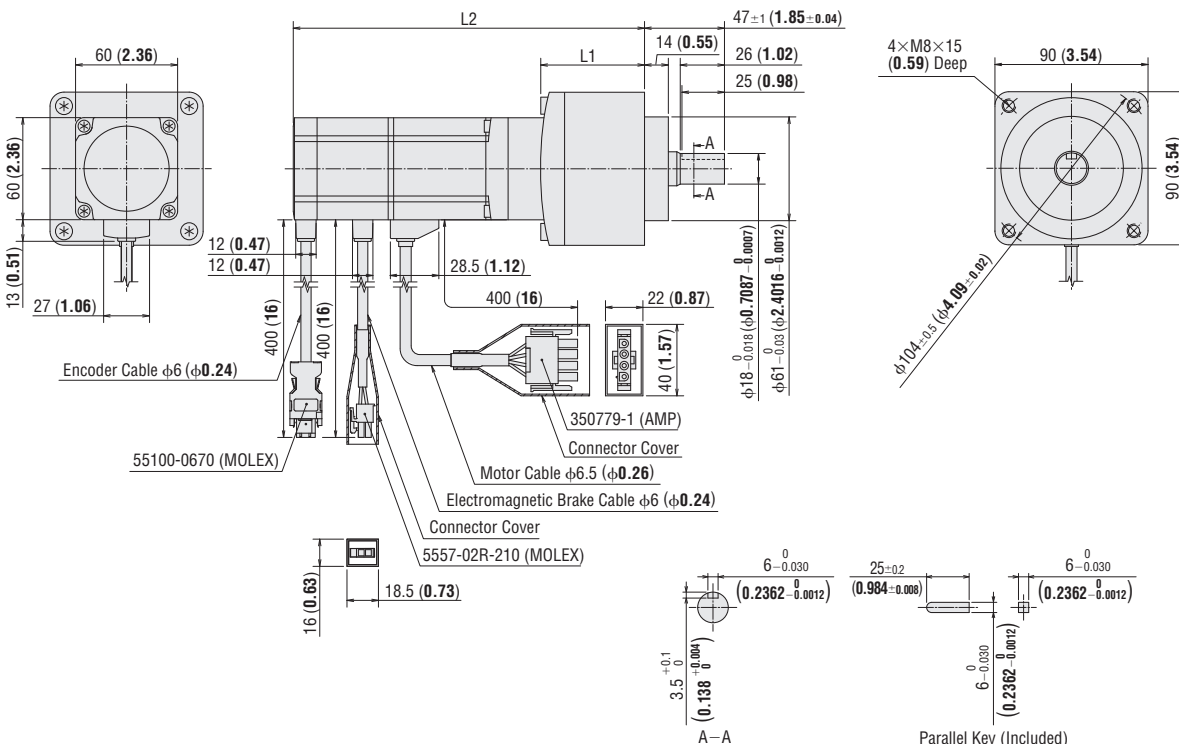

● Either **A** (single-phase 100-115 VAC) or **C** (single-phase 200-230 VAC/three-phase 200-230 VAC) indicating the power supply voltage is entered where the box (□) is located within the product name. A number indicating the gear ratio is entered where the box (□) is located within the product name.

◇ PJ Geared Type

Motor Frame Size 104 mm (4.09 in.)

Model	Motor Model	Gear Ratio	L1	L2	Mass kg (lb.)	DXF
<b>NX1075A5-J</b> □-3	NXM1075A-J□	<b>5, 10</b>	122.7 (4.83)	231.7 (9.12)	8.6 (18.9)	C221
		<b>25</b>			9.1 (20.0)	

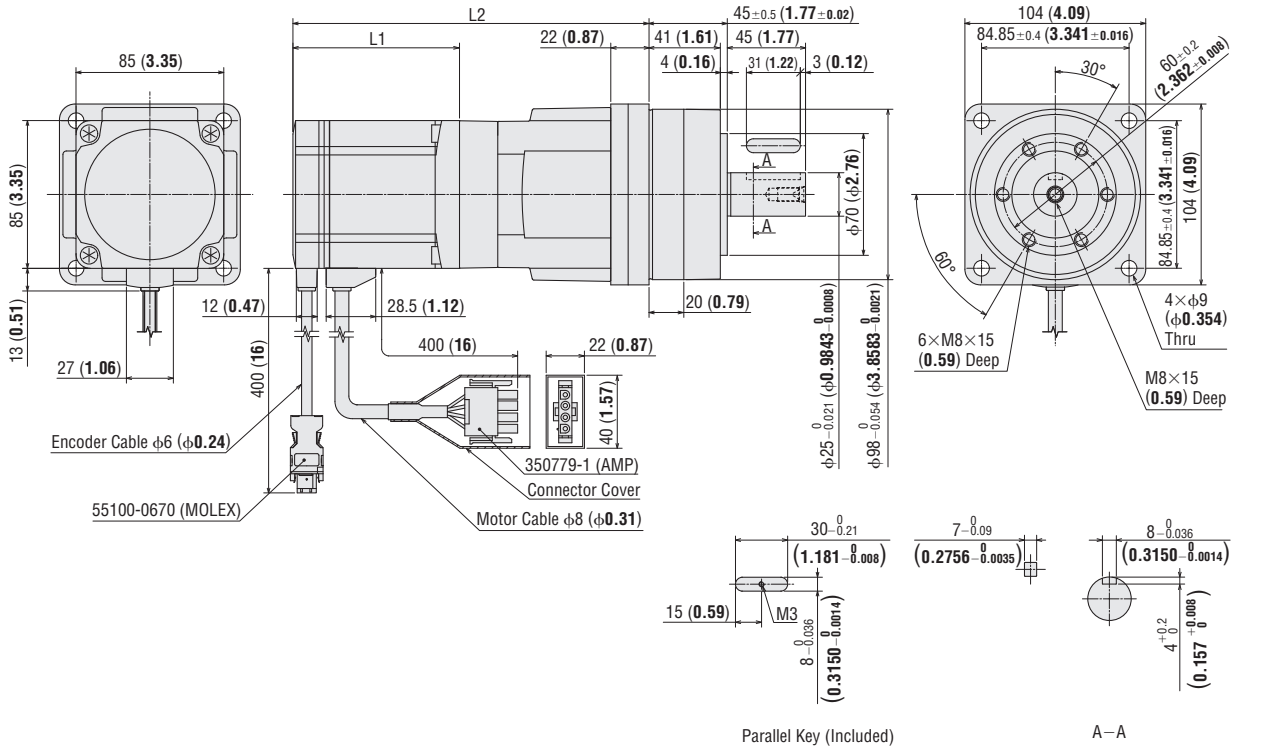

Motor Frame Size 104 mm (4.09 in.) Electromagnetic Brake Type

Model	Motor Model	Gear Ratio	L1	L2	Mass kg (lb.)	DXF
<b>NX1075MS-J</b> □-3	NXM1075M-J□	<b>5, 10</b>	164.7 (6.48)	273.7 (10.78)	9.6 (21.1)	C223
		<b>25</b>			10.1 (22.2)	

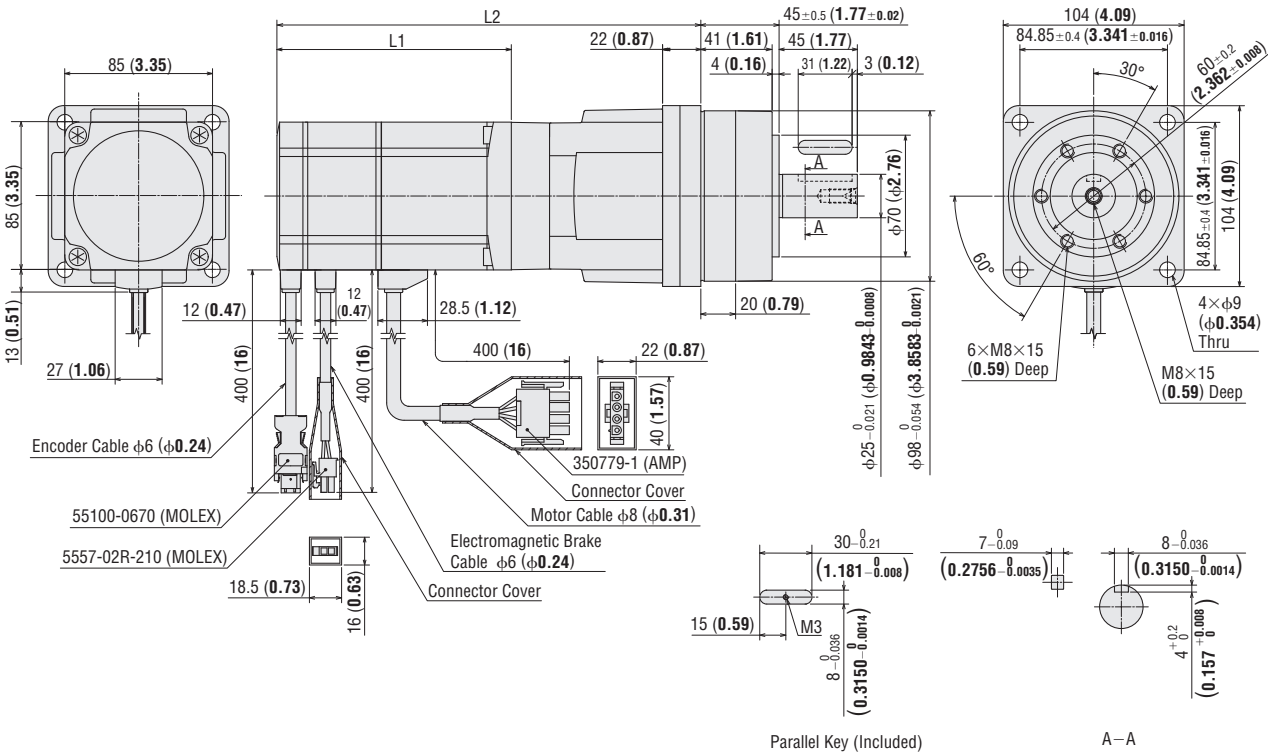

● A number indicating the gear ratio is entered where the box (□) is located within the product name.

## ● Driver

Driver Model: NXD20-A, NXD20-C

Mass: 0.9 kg (1.98 lb.)

**DXF** C209

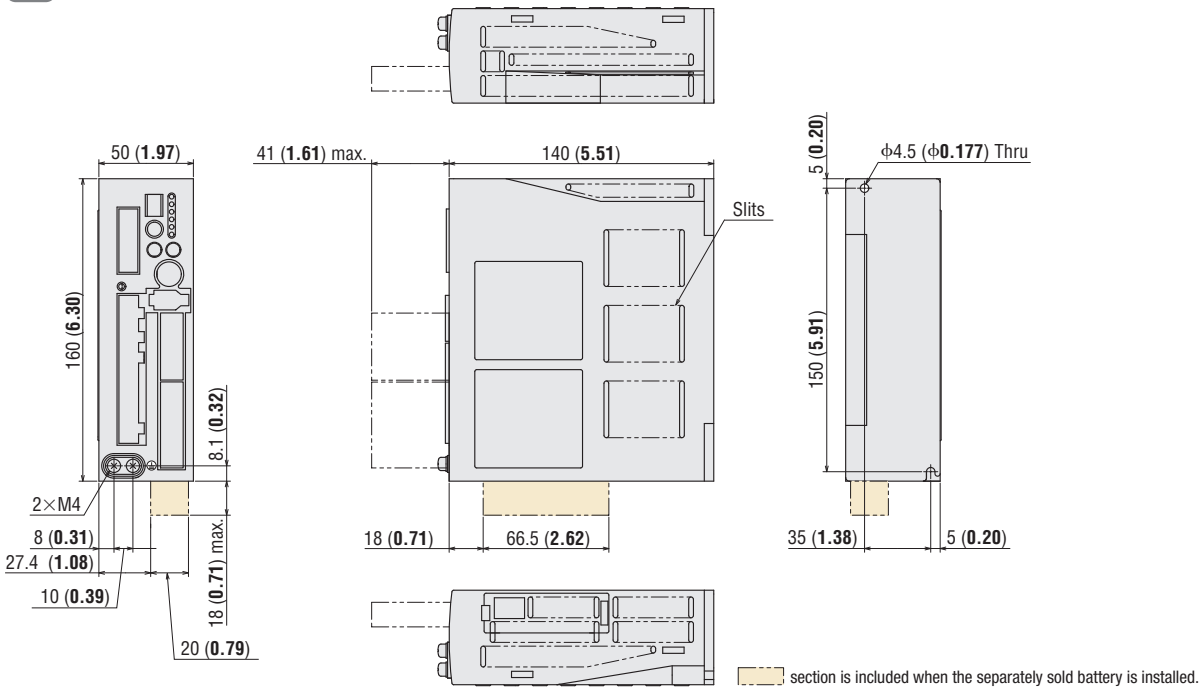

Driver Model: NXD75-S

Mass: 1.6 kg (3.52 lb.)

**DXF** C224

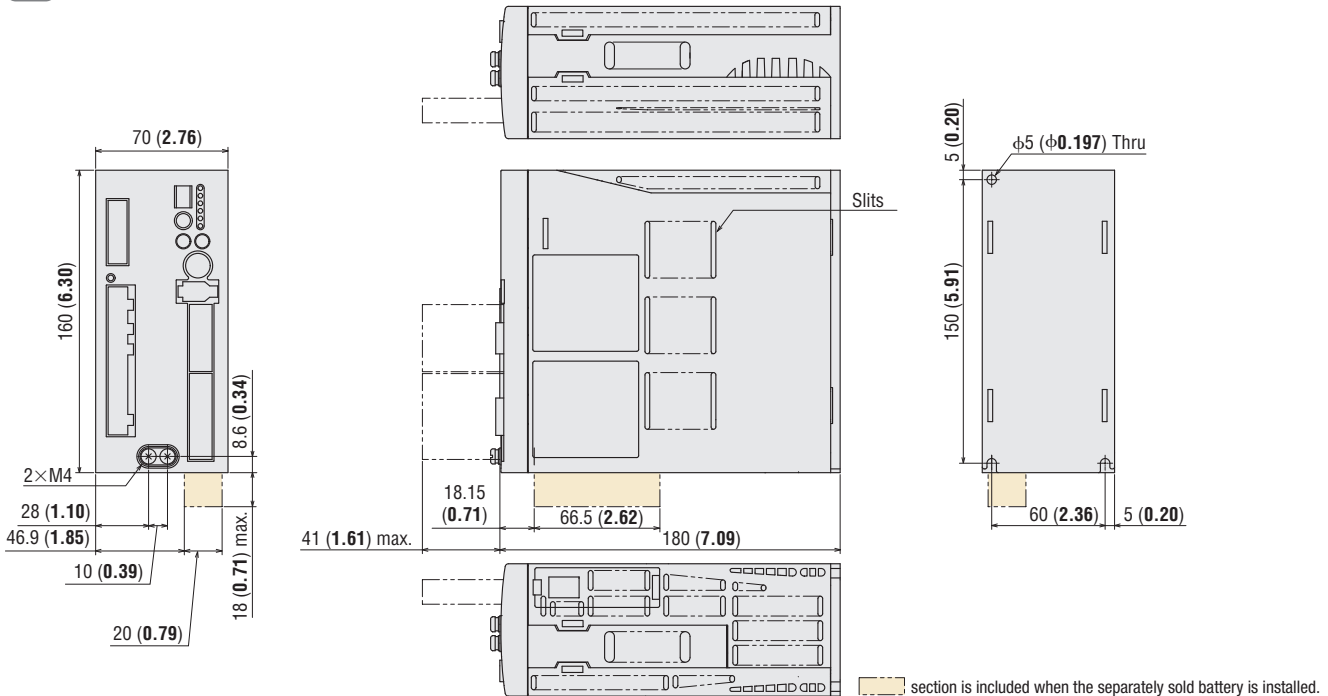

## ● Included

I/O Signal Connector (CN7)

Case: 10336-52A0-008 (SUMITOMO 3M)

Connector: 10136-3000PE (SUMITOMO 3M)

Connector for Regeneration Unit Input/Main Power Input Terminals (CN3)

Connector: 54928-0770 (MOLEX)

Connector for 24 VDC Power-Supply Input/Regeneration Unit Thermal Input/Electromagnetic Brake Terminals (CN1)

Connector: MC1.5/6-STF-3,5 (PHOENIX CONTACT Inc.)

Motor Connector (CN2)

Connector: 54928-0370 (MOLEX)

● Cable for Motor (Included), Cable for Encoder (Included), Cable for Electromagnetic Brake (Included)

● Cable for Motor

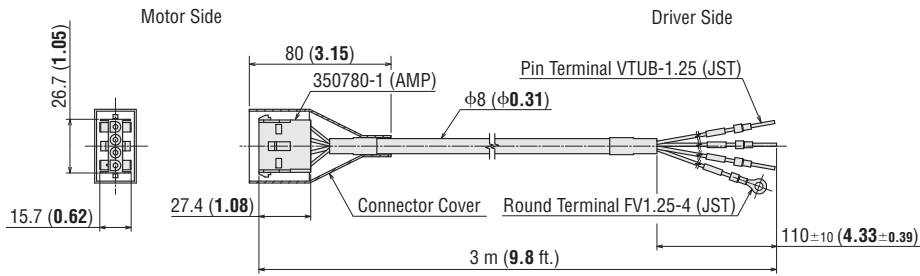

● Cable for Encoder

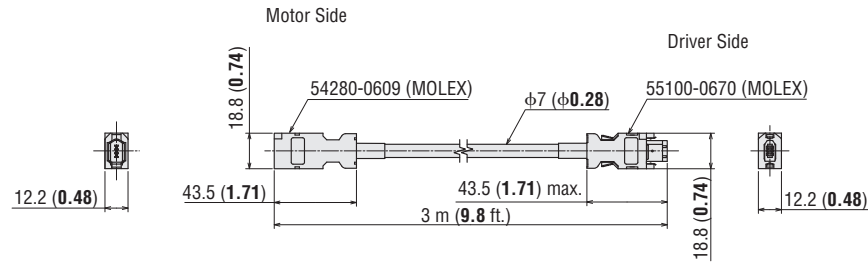

● Cable for Electromagnetic Brake  
 (Electromagnetic brake type only)

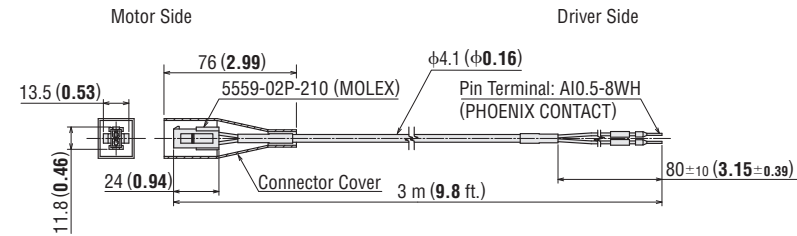



## Connection and Operation

- Names and Functions of Driver Parts (Common to position control, speed control, torque control, tension control modes)

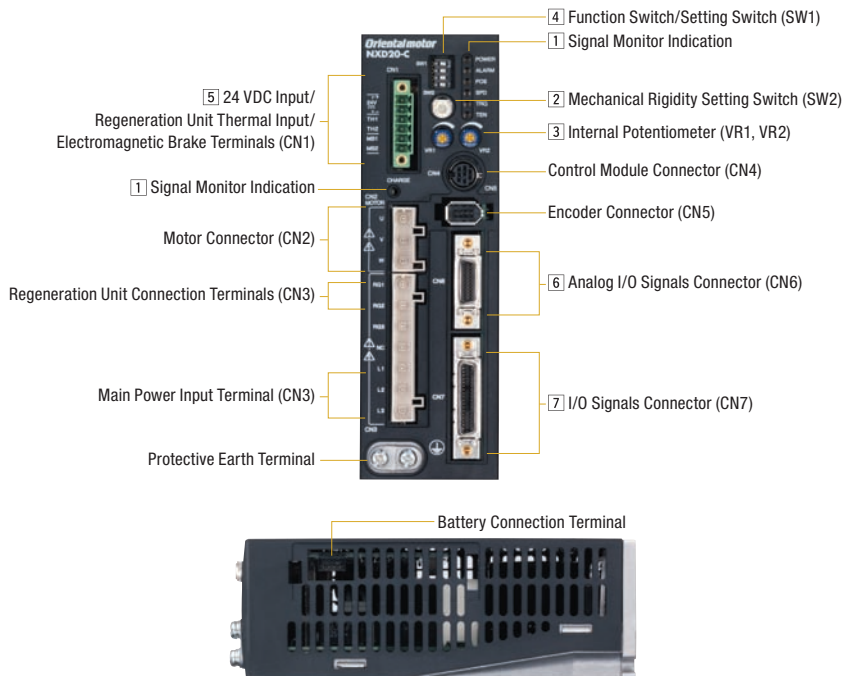

### 1 Signal Monitor Indication

#### ◇ LED Indicator

Indication	Color	Function	Lighting Condition
POWER	Green	Power Supply Indication	When the main power supply or 24 VDC power supply is input
ALARM	Red	Alarm Indication	When a protective function is activated (blinking)
POS	Green	Control Mode Indication	For Position Control Mode
SPD	Green	Control Mode Indication	For Speed Control Mode
TRQ	Green	Control Mode Indication	For Torque Control Mode
TEN	Green	Control Mode Indication	For Tension Control Mode
CHARGE	Red	Power Supply Indication	When the main power supply is on

#### ◇ Alarm Contents

Blink Count	Function	Operating Condition
2	Overheat Protection	When the temperature inside the driver exceeds 85°C (185°F)
	Motor Overheat Protection	When the motor temperature reaches 85°C (185°F)
	Overload Protection	When a load exceeding the rated torque is applied for longer than the permissible time
	Overspeed	When the motor output shaft speed exceeds 6000 r/min
	Command Pulse Error*	When a command pulse frequency that exceeds the maximum speed has been input with the motor output shaft speed
	Regeneration Unit Overheat	When the signal thermal protector for the regeneration unit has been activated
3	Overvoltage Protection	When the primary voltage of the driver's inverter exceeds the upper limit value
	Main Power Supply Error	When the main power supply has been cut off while an operation command is being input to the driver
	Undervoltage	When the primary voltage of the driver's inverter has fallen below the lower limit
4	Overflow*	When the positioning deviation has exceeded the overflow rotation amount (Initial value: 10 rotations)
5	Overcurrent Protection	An excessive current has flowed through the inverter power component inside the driver
7	Position Range Error*	When the command position has exceeded the absolute control coordinates while the absolute functions are enabled (control coordinates: -2 147 483 648 to 2 147 483 647)
	Absolute Position Loss*	When the absolute position is lost while the absolute functions are enabled
	ABS Not Supported*	When the battery is connected while the absolute functions are disabled
	No Battery*	When the battery is not connected or the battery cable is disconnected while the absolute functions are enabled
8	Electronic Gear Setting Error	When the resolution set by the electronic gear is outside the range of the specifications
	Sensor Error during Operation	When an abnormality has occurred in a sensor while the motor is rotating
	Encoder Communication Error	When an abnormality has occurred in communications between the driver and encoder
	Sensor Error during Initialization	When the main power supply or control power supply was turned on before the motor cable was connected to the driver
	Rotor Rotation during Initialization	The main power supply or control power supply was turned on while the motor was rotating
	Encoder EEPROM Error	The saved data for the encoder communications circuit was damaged
9	Motor Combination Error	A motor that cannot be combined with the other components was connected
	EEPROM Error	A motor control parameter is damaged

\* An alarm generated when used in position control mode.

2 Mechanical Rigidity Setting Switch (SW2)

Indication	Switch Name	Function	
SW2	Mechanical Rigidity Setting Switch	Position Control Mode	Sets the mechanical rigidity and the corresponding gain adjustment level with automatic tuning and semi-auto tuning. Factory setting: "6"
		Torque Control Mode	Not used.
		Tension Control Mode	Sets the minimum speed in simple control mode. (Not used in high function mode I and high function mode II.) Factory setting: "6"

3 Internal Potentiometer (VR1, VR2)

Indication	Switch Name	Function	
VR1 VR2	Internal Potentiometer	Position Control Mode	VR1: Sets the vibration suppression frequency. VR2: Not used.
		Speed Control Mode	VR1: Sets the speed command value. VR2: Sets the acceleration/deceleration time.
		Torque Control Mode	VR1: Sets the torque command value. VR2: Sets the speed limit.
		Tension Control Mode	VR1: Sets the tension command value. VR2: Sets the speed limit.

4 Function Switch/Setting Switch (SW1)

Indication	Switch Name	Function	
1	Control Mode Setting Switch	Selects the control mode.	
2		1 "OFF" 2 "OFF" → Position Control Mode [Factory setting] 1 "ON" 2 "OFF" → Speed Control Mode 1 "OFF" 2 "ON" → Torque Control Mode 1 "ON" 2 "ON" → Tension Control Mode	
3	Absolute System Setting Switch	Set when the accessory battery (sold separately) is installed to use the absolute functions. (This is effective in position control mode.) ON: Absolute Functions Enabled OFF: Absolute Functions Disabled [Factory setting]	
4	Pulse Input Mode Select Switch	Switches the pulse input mode between 1-pulse input mode and 2-pulse input mode. ON: 1-Pulse Input Mode [Factory setting] OFF: 2-Pulse Input Mode	

5 24 VDC Input/Regeneration Unit Thermal Input/ Electromagnetic Brake Terminals (CN1)

Indication	I/O	Terminal Name	Content
24V+	Input	24 VDC Power Input Terminal +	To separate the main power supply and control power supply, connect the power supplies here. The control power supply is not mandatory. When using an electromagnetic brake type motor, connect it as the power supply for the electromagnetic brake.
24V-		24 VDC Power Input Terminal -	
TH1		Regeneration Unit Thermal Input Terminal	Connect the <b>RGB100</b> or <b>RGB200</b> regeneration unit which are sold separately.
TH2		Regeneration Unit Thermal Input Terminal	When not connecting a regeneration unit, short these 2 terminals to each other.
MB1	Output	Electromagnetic Brake Terminal -	For an electromagnetic brake type motor, connect the electromagnetic brake line here.
MB2		Electromagnetic Brake Terminal +	

6 Analog I/O Signals Connector (CN6)

Indication	I/O	Pin Number	Code	Signal Name	
CN6	Input	1	V-REF	Analog Speed (Command/limit) Input	
	GND	2	SG	Signal Ground	
	Output	3	P-VREF	Reference Output Voltage for Analog Speed (Command/limit) Input	
		4	P-TREF	Analog Torque (Command/limit) Input	
	Input	5	T-REF	Analog Torque (Command/limit) Input	
	GND	6	SG	Signal Ground	
	Output	7	V-MON	Analog Speed Monitor Output	
	GND	8	SG	Signal Ground	
	Output	9	T-MON	Analog Torque Monitor Output	
	GND	10	SG	Signal Ground	
			11		
			12		
			13		
			14		
			15		
			16		
			17		
			18		
			19		
			20		

7 I/O Signals Connector (CN7)

- Position control mode → Page B-40
- Speed control mode → Page B-40
- Torque control mode → Page B-41
- Tension control mode → Page B-41

● Connection Diagram (Common to position control, speed control, torque control, and tension control modes)

◇ Connections with Peripheral Equipment

● For **NX620AC-3**

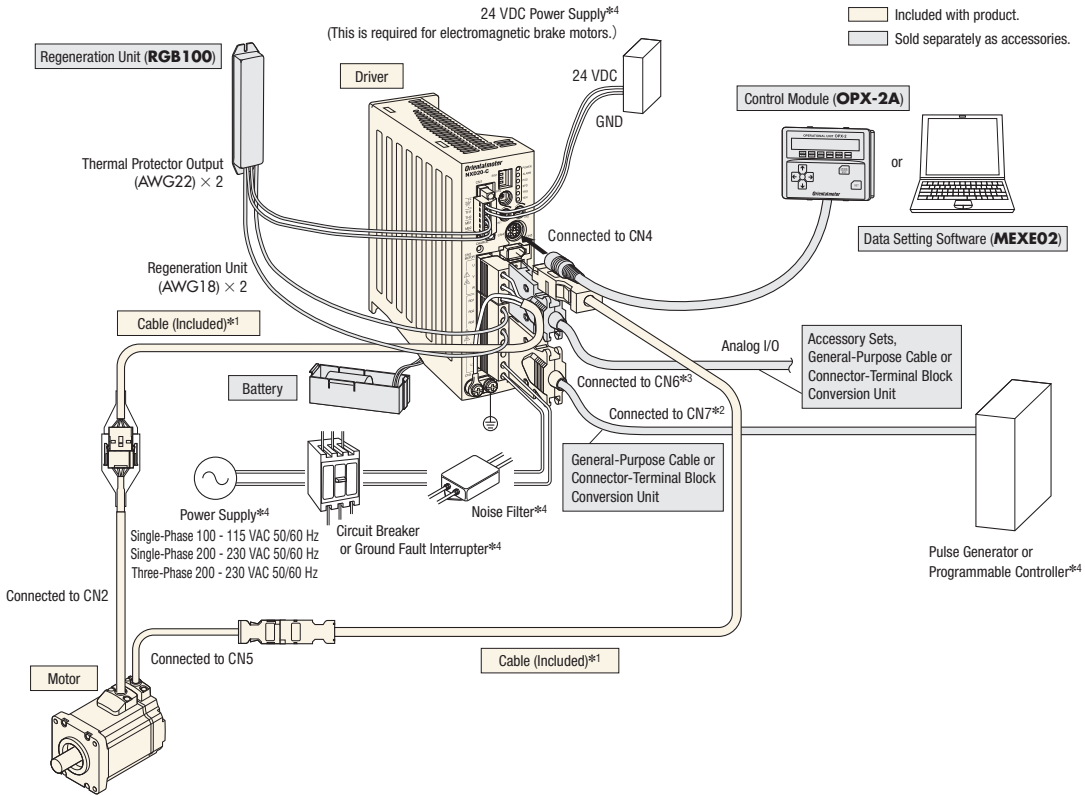

\*1 3 m (9.8 ft.) cables are included with the product. If you need cables longer than 3 m or flexible cables, select appropriate cables from the accessories (sold separately).

\*2 The control I/O connector (CN7) is included with the product, but you can also purchase an accessory general-purpose cable or connector – terminal block conversion unit (sold separately). Choose one or the other.

\*3 The Analog I/O Signals Connector (CN6) is not included with the product. You can also purchase an accessory set, general-purpose cable or connector – terminal block conversion unit (sold separately). Choose one that suits your needs.

\*4 Not supplied.

◇ Connecting the Main Power Supply

Prepare the following cable for the power supply lines.

Single-Phase 100-115 VAC: Three-Core Cable (AWG16 to 14)

Single-Phase 200-230 VAC: Three-Core Cable (AWG16 to 14)

Three-Phase 200-230 VAC: Four-Core Cable (AWG16 to 14)

● Single-Phase 100-115 VAC

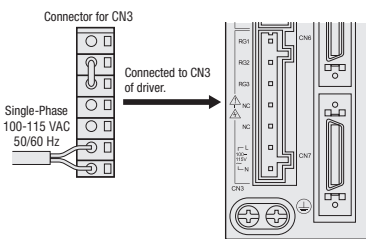

● Single-Phase 200-230 VAC

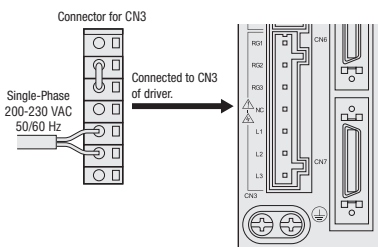

● Three-Phase 200-230 VAC

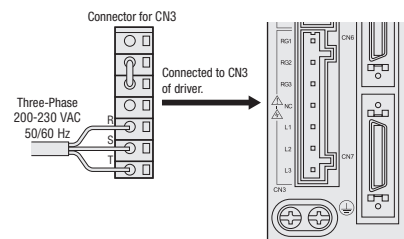

◇ Connecting the Control Power Supply

To separate the main power supply and control power supply, connect 24 VDC.

The control power supply is not mandatory.

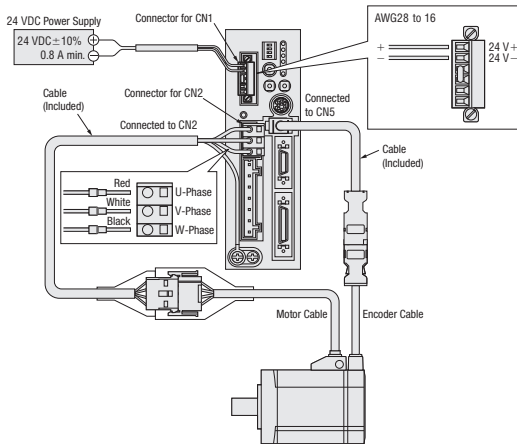

◇ Connecting the Electromagnetic Brake

Connect 24 VDC.

The main power supply and control power supply are separated in this case too.

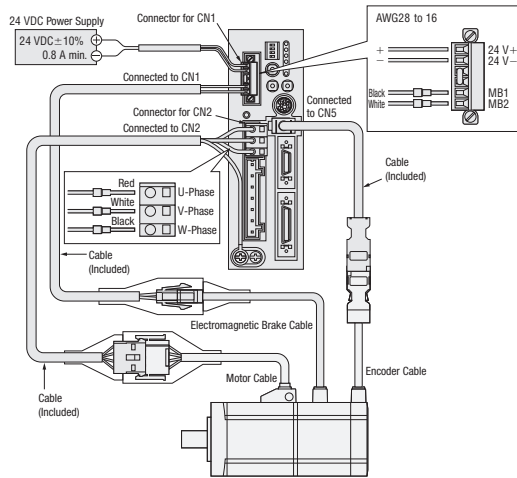

## ◇ Connection to Programmable Controller

- Connection Diagram for Connection with Current Sink Output Circuit

When pulse input is performed using the line driver mode

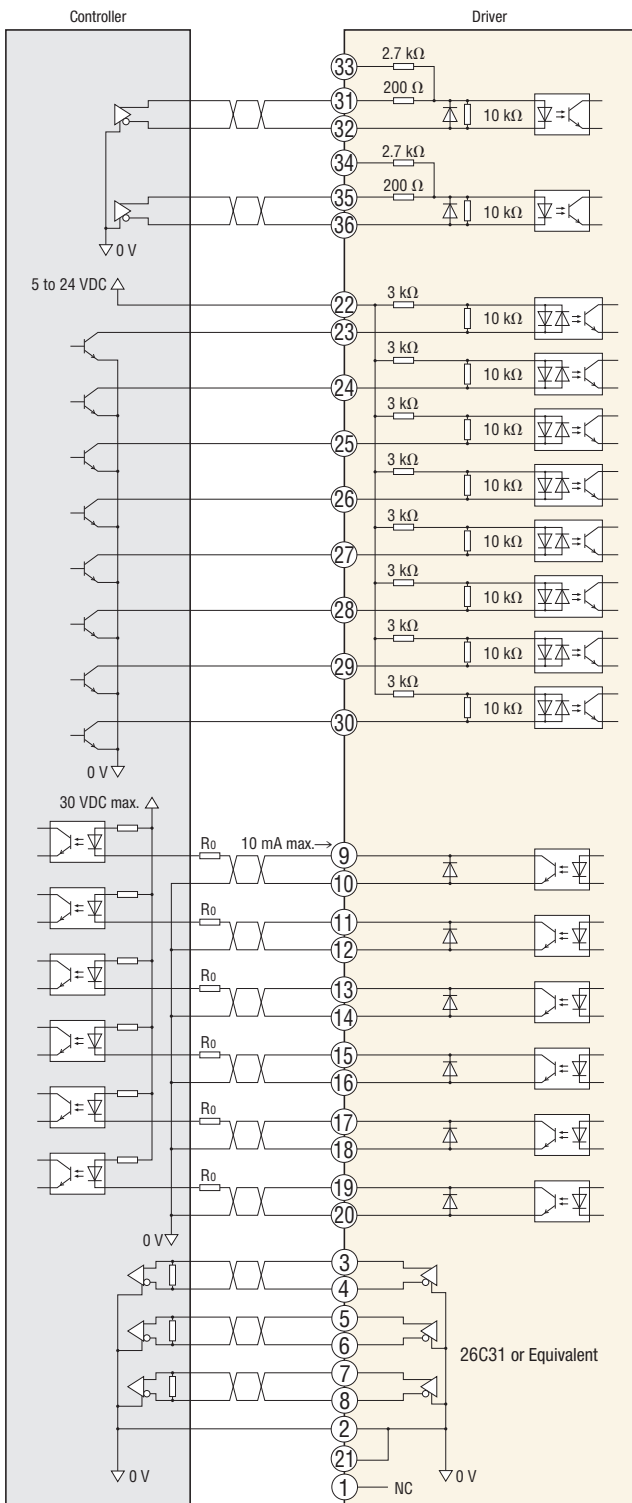

When the input voltage is 5 VDC

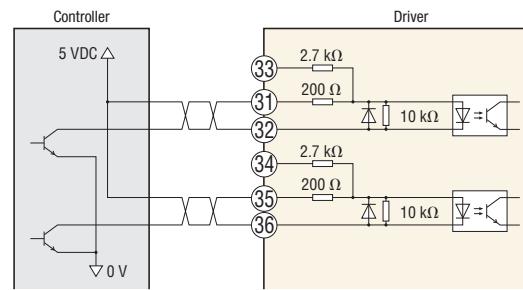

When the input voltage is 24 VDC

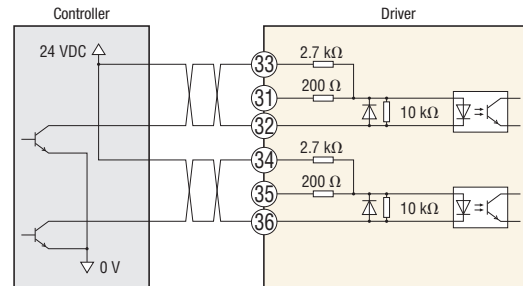

### Notes

- Use output signals of 30 VDC max. When the current value exceeds 10 mA, connect the external resistor  $R_o$ .
- Connect a terminating resistor of 100  $\Omega$  min. between the line receiver inputs.
- For the control I/O signal lines (CN7), use a multi-core shielded twisted-pair wire (AWG28 to 26) and keep the wiring length as short as possible [no more than 2 m (6.6 ft.)].
- Note that as the length of the pulse line increases, the maximum frequency decreases.
- Provide a distance of 200 mm (7.87 ft.) min. between the control I/O signal lines and power lines (power supply lines, motor lines and other large-current circuits).

◇ Connection to Programmable Controller

● Connection Diagram for Connection with Current Source Output Circuit

When pulse input is performed using the line driver mode

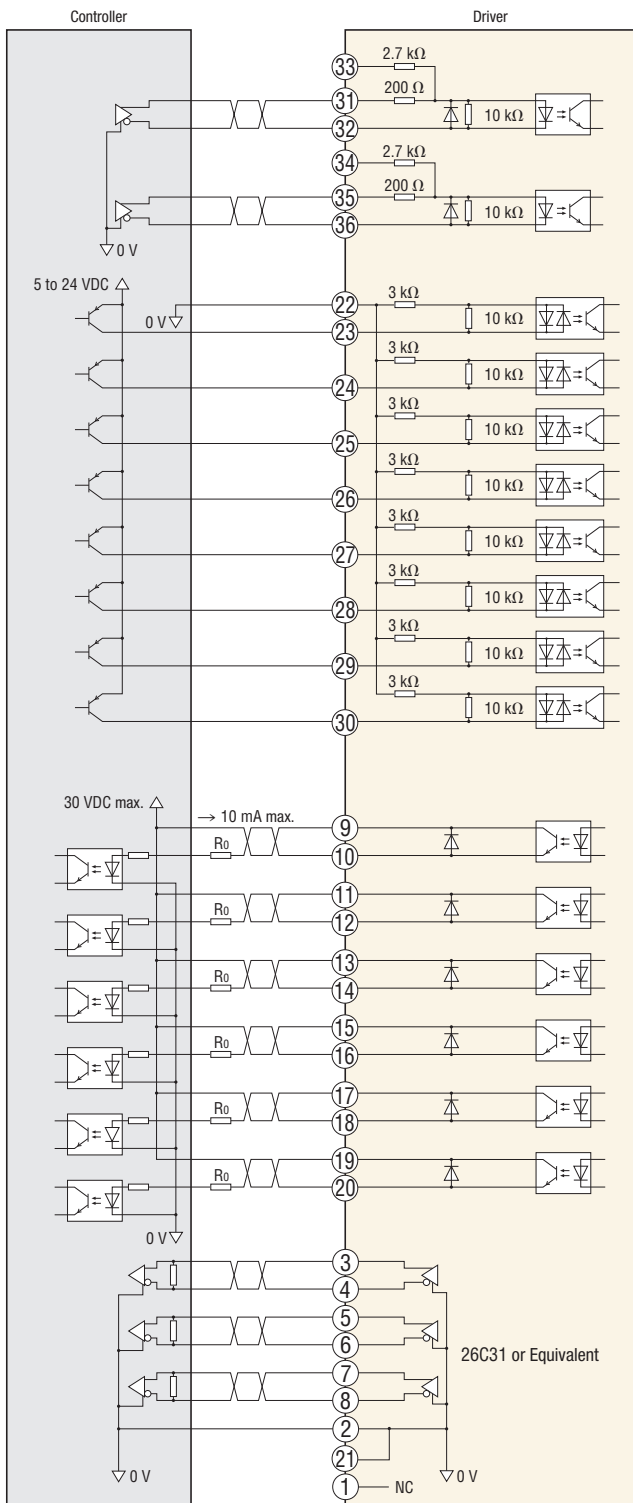

When the input voltage is 5 VDC

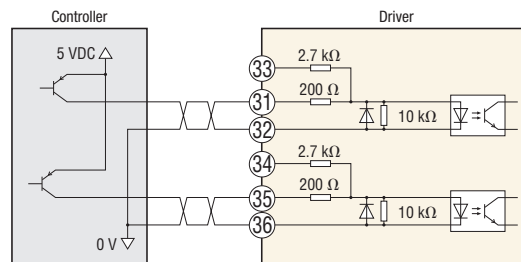

When the input voltage is 24 VDC

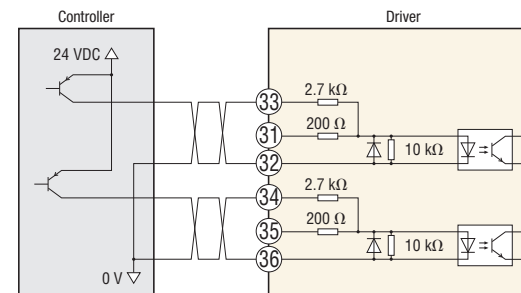

Notes

- Use output signals of 30 VDC max. When the current value exceeds 10 mA, connect the external resistor  $R_0$ .
- Connect a terminating resistor of 100  $\Omega$  min. between the line receiver inputs.
- For the control I/O signal lines (CN7), use a multi-core shielded twisted-pair wire (AWG28 to 26) and keep the wiring length as short as possible [no more than 2 m (6.6 ft.)].
- Note that as the length of the pulse line increases, the maximum frequency decreases.
- Provide a distance of 200 mm (7.87 ft.) min. between the control I/O signal lines and power lines (power supply lines, motor lines and other large-current circuits).

## ◇ Analog I/O Connection

When using analog I/O, the accessory set is required (sold separately).

Accessory Set → Page B-56

### • Input Circuit

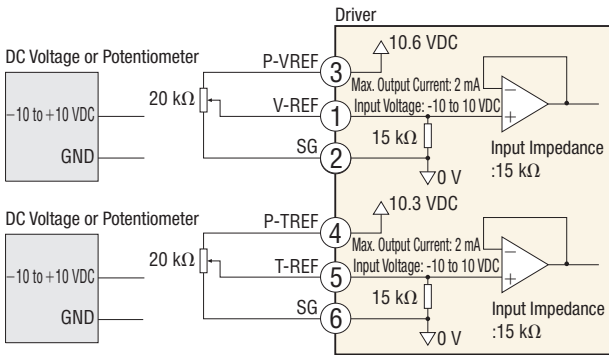

### • Output Circuit

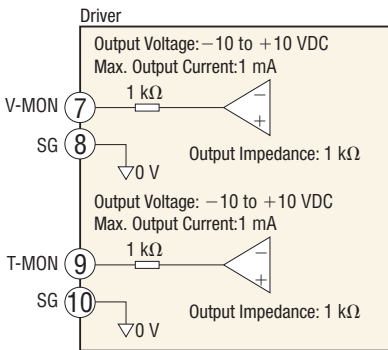

### Description of Position Control Mode I/O Signals

#### ● Position Control Mode

In position control mode, the following functions are enabled:

- External positioning operation using pulse input
- Torque limiting
- Absolute system
- Current position output
- Tuning
- Damping control

#### ● I/O Signals (CN7, 36 pins)

Indication	I/O	Pin Number	Code	Signal Name
	—	1	—	—
	GND	2	GND	Ground Connection
Output		3	ASG+	A-Phase Pulse Line Driver Output
		4	ASG—	
		5	BSG+	B-Phase Pulse Line Driver Output
		6	BSG—	
		7	ZSG1+	Z-Phase Pulse Line Driver Output
		8	ZSG1—	
		9	ALM+	Alarm Output
		10	ALM—	
		11	WNG+/MOVE+*/MBC+*	Warning Output/ Motor Moving Output*/ Electromagnetic Brake Control Signal Output*
		12	WNG—/MOVE—*/MBC—*	
		13	END+	Positioning Completion Output
		14	END—	
	Input		15	READY+/AL0+*/P-OUTR+
		16	READY—/AL0—*/P-OUTR—	
		17	TLC+/AL1+*/P-OUT0+	Torque Limiting Output/Alarm Code Output Bit 1*/Position Data Output Bit 0
		18	TLC—/AL1—*/P-OUT0—	
		19	ZSG2+/NEAR+*/AL2+*/ P-OUT1+	Z-Phase Pulse Open Collector Output/Positioning Near Output*/Alarm Code Output Bit 2*/Position Data Output Bit 1
		20	ZSG2—/NEAR—*/AL2—*/ P-OUT1—	
		21	GND	Ground Connection
		22	IN-COM	Input Common
		23	S-ON	Position Holding Input by Servo Control
		24	CLR/ALM-RST/P-CK	Deviation Clear Input/Alarm Reset Input/Position Data Transmission Clock Input
	25	P-REQ	Position Data Request Input	
	26	TL	Torque Limit Enable Input	
	27	MO	Data Selection Input	
	28	M1		
	29	P-PRESET	Position Preset Input	
	30	FREE	Shaft Free Input	
	31	PLS+/CW+	Pulse Input/CW Pulse Input	
	32	PLS—/CW—		
	33	PLS+24 V/CW+24 V	Pulse Input for 24 VDC/ CW Pulse Input	
	34	DIR+24 V/CCW+24 V	Rotation Direction Input for 24 VDC/CCW Pulse Input	
	35	DIR—/CCW—	Rotation Direction Input/ CCW Pulse Input	
	36	DIR—/CCW—		

\* Enabled when the settings are changed with the separately-sold control module (**OPX-2A**) or data setting software (**MEXE02**).

### Description of Speed Control Mode I/O Signals

#### ● Speed Control Mode

In speed control mode, the following functions are enabled:

- Speed control operation
- Torque limiting
- Tuning

#### ● I/O Signals (CN7, 36 pins)

Indication	I/O	Pin Number	Code	Signal Name
	—	1	—	—
	GND	2	GND	Ground Connection
Output		3	ASG+	A-Phase Pulse Line Driver Output
		4	ASG—	
		5	BSG+	B-Phase Pulse Line Driver Output
		6	BSG—	
		7	ZSG1+	Z-Phase Pulse Line Driver Output
		8	ZSG1—	
		9	ALM+	Alarm Output
		10	ALM—	
		11	WNG+/MOVE+*/MBC+*	Warning Output/ Motor Moving Output*/ Electromagnetic Brake Control Signal Output*
		12	WNG—/MOVE—*/MBC—*	
		13	VA+	Speed Attainment Output
		14	VA—	
	Input		15	READY+/AL0+*
		16	READY—/AL0—*	
		17	TLC+/AL1+*	Torque Limiting Output/Alarm Code Output Bit 1*
		18	TLC—/AL1—*	
		19	ZSG2+/ZV+*/AL2+*	Z-Phase Pulse Open Collector Output/Motor Zero Speed Output*/Alarm Code Output Bit 2*
		20	ZSG2—/ZV—*/AL2—*	
		21	GND	Ground Connection
		22	IN-COM	Input Common
		23	S-ON	Position Holding Input by Servo Control
		24	ALM-RST	Alarm Reset Input
	25	BRAKE	Instantaneous Stop Input	
	26	TL	Torque Limit Enable Input	
	27	MO	Data Selection Input	
	28	M1		
	29	M2		
	30	FREE	Shaft Free Input	
	31	CW+	CW Input	
	32	CW—		
	33	CW+24 V	CW Input for 24 VDC	
	34	CCW+24 V	CCW Input for 24 VDC	
	35	CCW+	CCW Input	
	36	CCW—		

\* Enabled when the settings are changed with the separately-sold control module (**OPX-2A**) or data setting software (**MEXE02**).



## Description of Torque Control Mode I/O Signals

### ● Torque Control Mode

In torque control mode, the following functions are enabled:

- Torque control operation
- Speed limit

### ● I/O Signals (CN7, 36 pins)

Indication	I/O	Pin Number	Code	Signal Name
	—	1	—	—
	GND	2	GND	Ground Connection
CN7	Output	3	ASG+	A-Phase Pulse Line Driver
		4	ASG—	Output
		5	BSG+	B-Phase Pulse Line Driver
		6	BSG—	Output
		7	ZSG1+	Z-Phase Pulse Line Driver
		8	ZSG1—	Output
		9	ALM+	Alarm Output
		10	ALM—	
		11	WNG+/MOVE+*/MBC+*	Warning Output/ Motor Moving Output*/ Electromagnetic Brake Control Signal Output*
		12	WNG—/MOVE—*/MBC—*	
		13	—	—
		14	—	—
		15	READY+/ALO+*	Operation Ready Output/ Alarm Code Output Bit 0*
16	READY—/ALO—*			
17	VLC+/AL1+*	Speed Limit Output/Alarm Code Output Bit 1*		
18	VLC—/AL1—*			
19	ZSG2+/ZV+*/AL2+*	Z-Phase Pulse Open Collector Output*/Motor Zero Speed Output*/Alarm Code Output Bit 2*		
20	ZSG2—/ZV—*/AL2—*			
	GND	21	GND	Ground Connection
CN7	Input	22	IN-COM	Input Common
		23	—	—
		24	ALM-RST	Alarm Reset Input
		25	—	—
		26	—	—
		27	M0	Data Selection Input
		28	M1	
		29	M2	
		30	FREE	Shaft Free Input
		31	CW+	CW Input
		32	CW—	
		33	CW+24 V	CW Input for 24 VDC
		34	CCW+24 V	CCW Input for 24 VDC
		35	CCW+	CCW Input
		36	CCW—	

\* Enabled when the settings are changed with the separately-sold control module (**OPX-2A**) or data setting software (**MEXE02**).

## Description of Tension Control Mode I/O Signals

### ● Tension Control Mode

When winding a roll of film, paper or the like, the diameter of the material is different at the start of the winding and at the end of the winding. Accordingly, control is required to vary the torque with the diameter in order to hold the tension constant. In tension control mode, such control is enabled.

In tension control mode, there are 3 operating modes. The operating mode can be selected and the operating data is set with the separately-sold control module (**OPX-2A**) or data setting software (**MEXE02**).

Operating Mode	Content
Simple Mode	The tension is controlled so it is constant when the feed speed is constant such as during winding operation. The motor speed and the torque are inversely proportional.
High Function Mode I	The current winding (winding out) diameter is automatically calculated based on the initial diameter, the material thickness and the final diameter. The tension is controlled to stay constant regardless of the operating speed.
High Function Mode II	In addition to the contents of high function mode I, the load inertia is calculated within the driver from the material inertia and the core inertia. The tension is controlled to stay constant even during acceleration/deceleration.

Setting Item	Operating Mode		
	Simple Mode	High Function Mode I	High Function Mode II
Tension Command Value	○	○	○
Material Thickness	—	○	○
Initial Diameter	—	○	○
Final Diameter	—	○	○
Material Inertia	—	—	○
Core Inertia	—	—	○
Taper Setting	—	○	○
Speed Limit	○	○	○

### ● I/O Signals (CN7, 36 pins)

Indication	I/O	Pin Number	Code	Signal Name	
	—	1	—	—	
CN7	Output	GND	2	GND	Ground Connection
		3	ASG+	A-Phase Pulse Line Driver	
		4	ASG—	Output	
		5	BSG+	B-Phase Pulse Line Driver	
		6	BSG—	Output	
		7	ZSG1+	Z-Phase Pulse Line Driver	
		8	ZSG1—	Output	
		9	ALM+	Alarm Output	
		10	ALM—		
		11	WNG+/MOVE+*/MBC+*	Warning Output/ Motor Moving Output*/ Electromagnetic Brake Control Signal Output*	
		12	WNG—/MOVE—*/MBC—*		
		13	—	—	
		14	—	—	
15	READY+/ALO+*	Operation Ready Output/ Alarm Code Output Bit 0*			
16	READY—/ALO—*				
17	VLC+/AL1+*	Speed Limit Output/Alarm Code Output Bit 1*			
18	VLC—/AL1—*				
19	ZSG2+/ZV+*/AL2+*	Z-Phase Pulse Open Collector Output*/Motor Zero Speed Output*/Alarm Code Output Bit 2*			
20	ZSG2—/ZV—*/AL2—*				
	GND	21	GND	Ground Connection	
CN7	Input	22	IN-COM	Input Common	
		23	—	—	
		24	ALM-RST	Alarm Reset Input	
		25	—	—	
		26	W-RESET	Winding Diameter Reset Input	
		27	M0	Data Selection Input	
		28	M1		
		29	M2		
		30	FREE	Shaft Free Input	
		31	CW+	CW Input	
		32	CW—		
		33	CW+24 V	CW Input for 24 VDC	
		34	CCW+24 V	CCW Input for 24 VDC	
		35	CCW+	CCW Input	
		36	CCW—		

\* Enabled when the settings are changed with the separately-sold control module (**OPX-2A**) or data setting software (**MEXE02**).

## Motor and Driver Combinations

Model names for motor and driver combinations are shown below.

### Standard Type

Power-Supply Input	Output Power	Model	Motor Model	Driver Model
Single-Phase 100-115 VAC	50 W (1/15 HP)	<b>NX45AA-3</b>	NXM45A	NXD20-A
	100 W (1/8 HP)	<b>NX410AA-3</b>	NXM410A	
	200 W (1/4 HP)	<b>NX620AA-3</b>	NXM620A	
Single-Phase/ Three-Phase 200-230 VAC	50 W (1/15 HP)	<b>NX45AC-3</b>	NXM45A	NXD20-C
	100 W (1/8 HP)	<b>NX410AC-3</b>	NXM410A	
	200 W (1/4 HP)	<b>NX620AC-3</b>	NXM620A	
Three-Phase 200-230 VAC	400 W (1/2 HP)	<b>NX640AS-3</b>	NXM640A	NXD75-S
	750 W (1 HP)	<b>NX975AS-3</b>	NXM975A	

### PS Geared Type

Power-Supply Input	Output Power	Model	Motor Model	Driver Model
Single-Phase 100-115 VAC	50 W (1/15 HP)	<b>NX65AA-PS5-3</b>	NXM65A-PS5	NXD20-A
		<b>NX65AA-PS10-3</b>	NXM65A-PS10	
		<b>NX65AA-PS25-3</b>	NXM65A-PS25	
	100 W (1/8 HP)	<b>NX610AA-PS5-3</b>	NXM610A-PS5	
		<b>NX610AA-PS10-3</b>	NXM610A-PS10	
		<b>NX610AA-PS25-3</b>	NXM610A-PS25	
200 W (1/4 HP)	<b>NX920AA-PS5-3</b>	NXM920A-PS5		
	<b>NX920AA-PS10-3</b>	NXM920A-PS10		
	<b>NX920AA-PS25-3</b>	NXM920A-PS25		
Single-Phase/ Three-Phase 200-230 VAC	50 W (1/15 HP)	<b>NX65AC-PS5-3</b>	NXM65A-PS5	NXD20-C
		<b>NX65AC-PS10-3</b>	NXM65A-PS10	
		<b>NX65AC-PS25-3</b>	NXM65A-PS25	
	100 W (1/8 HP)	<b>NX610AC-PS5-3</b>	NXM610A-PS5	
		<b>NX610AC-PS10-3</b>	NXM610A-PS10	
		<b>NX610AC-PS25-3</b>	NXM610A-PS25	
	200 W (1/4 HP)	<b>NX920AC-PS5-3</b>	NXM920A-PS5	
		<b>NX920AC-PS10-3</b>	NXM920A-PS10	
		<b>NX920AC-PS25-3</b>	NXM920A-PS25	
Three-Phase 200-230 VAC	400 W (1/2 HP)	<b>NX940AS-PS5-3</b>	NXM940A-PS5	NXD75-S
		<b>NX940AS-PS10-3</b>	NXM940A-PS10	
		<b>NX940AS-PS25-3</b>	NXM940A-PS25	

### PJ Geared Type

Power-Supply Input	Output Power	Model	Motor Model	Driver Model
Three-Phase 200-230 VAC	750 W (1 HP)	<b>NX1075AS-J5-3</b>	NXM1075A-J5	NXD75-S
		<b>NX1075AS-J10-3</b>	NXM1075A-J10	
		<b>NX1075AS-J25-3</b>	NXM1075A-J25	

### Standard Type with Electromagnetic Brake

Power-Supply Input	Output Power	Model	Motor Model	Driver Model
Single-Phase 100-115 VAC	50 W (1/15 HP)	<b>NX45MA-3</b>	NXM45M	NXD20-A
	100 W (1/8 HP)	<b>NX410MA-3</b>	NXM410M	
	200 W (1/4 HP)	<b>NX620MA-3</b>	NXM620M	
Single-Phase/ Three-Phase 200-230 VAC	50 W (1/15 HP)	<b>NX45MC-3</b>	NXM45M	NXD20-C
	100 W (1/8 HP)	<b>NX410MC-3</b>	NXM410M	
	200 W (1/4 HP)	<b>NX620MC-3</b>	NXM620M	
Three-Phase 200-230 VAC	400 W (1/2 HP)	<b>NX640MS-3</b>	NXM640M	NXD75-S
	750 W (1 HP)	<b>NX975MS-3</b>	NXM975M	

### PS Geared Type with Electromagnetic Brake

Power-Supply Input	Output Power	Model	Motor Model	Driver Model
Single-Phase 100-115 VAC	50 W (1/15 HP)	<b>NX65MA-PS5-3</b>	NXM65M-PS5	NXD20-A
		<b>NX65MA-PS10-3</b>	NXM65M-PS10	
		<b>NX65MA-PS25-3</b>	NXM65M-PS25	
	100 W (1/8 HP)	<b>NX610MA-PS5-3</b>	NXM610M-PS5	
		<b>NX610MA-PS10-3</b>	NXM610M-PS10	
		<b>NX610MA-PS25-3</b>	NXM610M-PS25	
200 W (1/4 HP)	<b>NX920MA-PS5-3</b>	NXM920M-PS5		
	<b>NX920MA-PS10-3</b>	NXM920M-PS10		
	<b>NX920MA-PS25-3</b>	NXM920M-PS25		
Single-Phase/ Three-Phase 200-230 VAC	50 W (1/15 HP)	<b>NX65MC-PS5-3</b>	NXM65M-PS5	NXD20-C
		<b>NX65MC-PS10-3</b>	NXM65M-PS10	
		<b>NX65MC-PS25-3</b>	NXM65M-PS25	
	100 W (1/8 HP)	<b>NX610MC-PS5-3</b>	NXM610M-PS5	
		<b>NX610MC-PS10-3</b>	NXM610M-PS10	
		<b>NX610MC-PS25-3</b>	NXM610M-PS25	
	200 W (1/4 HP)	<b>NX920MC-PS5-3</b>	NXM920M-PS5	
		<b>NX920MC-PS10-3</b>	NXM920M-PS10	
		<b>NX920MC-PS25-3</b>	NXM920M-PS25	
Three-Phase 200-230 VAC	400 W (1/2 HP)	<b>NX940MS-PS5-3</b>	NXM940M-PS5	NXD75-S
		<b>NX940MS-PS10-3</b>	NXM940M-PS10	
		<b>NX940MS-PS25-3</b>	NXM940M-PS25	

### PJ Geared Type with Electromagnetic Brake

Power-Supply Input	Output Power	Model	Motor Model	Driver Model
Three-Phase 200-230 VAC	750 W (1 HP)	<b>NX1075MS-J5-3</b>	NXM1075M-J5	NXD75-S
		<b>NX1075MS-J10-3</b>	NXM1075M-J10	
		<b>NX1075MS-J25-3</b>	NXM1075M-J25	

## Extended Functions

With the separately-sold control module (**OPX-2A**) or data editing software (**MEXE02**), the parameters, operating data, resolution, etc. can be set to suit your equipment. The settings that can be set with extended functions depend on the mode used.



Control Module (**OPX-2A**)  
→ Page B-55

Data setting software (**MEXE02**)  
→ Page B-55

### Position Control Mode

#### ◇ Operating Data

Item	Content
Torque Limiting	Sets the torque limiting value.
Vibration Suppression Frequency	Sets the damping control frequency.

#### ◇ System Parameters

Item	Content
Electronic Gear A	Sets the electronic gear denominator.
Electronic Gear B	Sets the electronic gear numerator.
Encoder Output Electronic Gear A	Sets the electronic gear denominator for encoder output.
Encoder Output Electronic Gear B	Sets the electronic gear numerator for encoder output.
Pulse Input Mode	Selects the pulse input mode.
Operation after Absolute Position Loss Alarm Reset	Selects the operation mode for after the absolute position loss alarm is reset.
Analog Input Signal	Enables/disables analog input signals.
Motor Rotation Direction	Selects the motor rotation direction.
Control Module Initial Display	Selects the initial display for when communications start between the control module and the driver. If an item is selected that is not displayed in position control mode, the monitor mode top screen becomes the initial display.

#### ◇ Application Parameters

Item	Content
Gain Tuning Mode Selection	Selects the gain tuning mode.
Load Inertia Ratio	Sets the ratio of the load inertia and motor inertia.
Mechanical Rigidity Setting	Selects the rigidity of automatic tuning, semi-auto tuning, and manual tuning.
Position Loop Gain	Sets the position loop gain. The larger this value, the higher the responsiveness.
Speed Loop Gain	Sets the speed loop gain. The larger this value, the higher the responsiveness.
Speed Loop Integration Time Constant	Sets the speed loop integration time constant. The smaller this value, the higher the responsiveness.
Speed Feed-Forward Ratio	Sets the speed feed-forward ratio. The larger this value, the higher the responsiveness.
S-ON Signal Logic	Switches the S-ON input logic.
Output Signal Selection 1	Selects the output signal.
Output Signal Selection 2	Selects the output signal.
Positioning Completion Output Range	Sets the END output conditions.
Positioning Near Output Range	Sets the NEAR output conditions.
MOVE Signal Min. ON Time	Sets the min. duration that MOVE output is ON.
Preset Value	Sets the preset position.
Alarm Code Output	Enables/disables alarm code output.
Analog Torque Limit Gain	Sets the torque limiting for 1 V of analog input voltage.
Analog Torque Limiting Offset Voltage	Sets the offset voltage for analog torque limiting input.
Analog Input Signal Automatic Offset	Enables/disables analog input signal automatic offset.
Analog Speed Monitor Max. Value	Sets the max. value for the analog speed monitor. The slope for the analog speed monitor output is decided.
Analog Speed Monitor Max. Voltage	Sets the monitor output voltage for the max. value of the analog speed monitor.
Analog Speed Monitor Offset Voltage	Sets the offset voltage for the analog speed monitor.
Analog Torque Monitor Max. Value	Sets the max. value for the analog torque monitor. The slope for the analog torque monitor output is decided.
Analog Torque Monitor Max. Voltage	Sets the monitor output voltage for the max. value of the analog torque monitor.
Analog Torque Monitor Offset Voltage	Sets the offset voltage for analog torque monitor.
Mechanical Rigidity Setting Switch	Enables/disables the driver's mechanical rigidity setting switch (SW2).
Command Filter	Sets the command filter time constant.
Damping Control	Enables/disables damping control.
Overflow Alarm	Sets the condition for an overflow alarm with a motor shaft rotation amount.
Overflow Warning	Sets the condition for an overflow warning with a motor shaft rotation amount.
Overvoltage Warning	Sets the voltage at which an overvoltage warning is issued.
Undervoltage Warning	Sets the voltage at which an undervoltage warning is issued.
Overheat Warning	Sets the temperature at which an overheat warning is issued.
Overload Warning	Sets the condition for which an overload warning is issued.
Overspeed Warning	Sets the speed at which an overspeed warning is issued.
Gear Ratio for Speed Monitor	Sets the geared motor gear ratio for speed monitor.

● Speed Control Mode

◇ Operating Data

Item	Content
Operating Speed	Sets the operating speed.
Torque Limiting	Sets the torque limiting value.
Acceleration Time	Sets the acceleration time per 1000 r/min.
Deceleration Time	Sets the deceleration time per 1000 r/min.

◇ System Parameters

Item	Content
Encoder Output Electronic Gear A	Sets the electronic gear denominator for encoder output.
Encoder Output Electronic Gear B	Sets the electronic gear numerator for encoder output.
Operation Selection during Speed Control Mode Stop	Sets the operation during speed control mode is stopped.
Analog Input Signal	Enables/disables analog input signals.
Motor Rotation Direction	Selects the motor rotation direction.
Control Module Initial Display	Selects the initial display for when communications start between the control module and the driver. If an item is selected that is not displayed in speed control mode, the monitor mode top screen becomes the initial display.

◇ Application Parameters

Item	Content
Gain Tuning Mode Selection	Selects the gain tuning mode.
Load Inertia Ratio	Sets the ratio of the load inertia and motor inertia.
Mechanical Rigidity Setting	Selects the rigidity of automatic tuning semi-auto tuning, and manual tuning.
Position Loop Gain*	Sets the position loop gain. The larger this value, the higher the responsiveness.
Speed Loop Gain*	Sets the speed loop gain. The larger this value, the higher the responsiveness.
Speed Loop Integration Time Constant*	Sets the speed loop integration time constant. The smaller this value, the higher the responsiveness.
Speed Feed-Forward Ratio*	Sets the speed feed-forward ratio. The larger this value, the higher the responsiveness.
S-ON Signal Logic	Switches the S-ON input logic.
BRAKE Signal Logic	Switches the BRAKE input logic.
Output Signal Selection 1	Selects the output signal.
Output Signal Selection 2	Selects the output signal.
Zero Speed Output Range	Sets the ZV output conditions.
Speed Attainment Output Range	Sets the VA output conditions.
MOVE Signal Min. ON Time	Sets the min. duration that MOVE output is ON.
Alarm Code Output	Enables/disables alarm code output.
Analog Speed Command Gain	Sets the speed command for 1 V of analog input voltage.
Analog Speed Command Clamp	Sets the speed at which the analog speed command is clamped to zero.
Analog Speed Command Offset Voltage	Sets the offset voltage for analog speed command input.
Analog Torque Limit Gain	Sets the torque limiting for 1 V of analog input voltage.
Analog Torque Limiting Offset Voltage	Sets the offset voltage for analog torque limiting input.
Analog Input Signal Automatic Offset	Enables/disables analog input signal automatic offset.
Analog Speed Monitor Max. Value	Sets the max. value for the analog speed monitor. The slope for the analog speed monitor output is decided.
Analog Speed Monitor Max. Voltage	Sets the monitor output voltage for the max. value of the analog speed monitor.
Analog Speed Monitor Offset Voltage	Sets the offset voltage for the analog speed monitor.
Analog Torque Monitor Max. Value	Sets the max. value for the analog torque monitor. The slope for the analog torque monitor output is decided.
Analog Torque Monitor Max. Voltage	Sets the monitor output voltage for the max. value of the analog torque monitor.
Analog Torque Monitor Offset Voltage	Sets the offset voltage for analog torque monitor.
Mechanical Rigidity Setting Switch	Enables/disables the driver's mechanical rigidity setting switch (SW2).
Overvoltage Warning	Sets the voltage at which an overvoltage warning is issued.
Undervoltage Warning	Sets the voltage at which an undervoltage warning is issued.
Overheat Warning	Sets the temperature at which an overheat warning is issued.
Overload Warning	Sets the condition for which an overload warning is issued.
Overspeed Warning	Sets the speed at which an overspeed warning is issued.
Gear Ratio for Speed Monitor	Sets the geared motor gear ratio for speed monitor.

\*When the parameter for selecting operation when the speed control mode is stopped is set to "servo lock".

## ● Torque Control Mode

### ◇ Operating Data

Item	Content
Torque Command	Sets the torque command value. 100% is the rated torque.
Speed Limit	Sets the speed limiting value.

### ◇ System Parameters

Item	Content
Encoder Output Electronic Gear A	Sets the electronic gear denominator for encoder output.
Encoder Output Electronic Gear B	Sets the electronic gear numerator for encoder output.
Analog Input Signal	Enables/disables analog input signals.
Motor Rotation Direction	Sets the torque direction.
Control Module Initial Display	Selects the initial display for when communications start between the control module and the driver. If an item is selected that is not displayed in torque control mode, the monitor mode top screen becomes the initial display.

### ◇ Application Parameters

Item	Content
Output Signal Selection 1	Selects the output signal.
Output Signal Selection 2	Selects the output signal.
Zero Speed Output Range	Sets the ZV output conditions.
MOVE Signal Min. ON Time	Sets the min. duration that MOVE output is ON.
Alarm Code Output	Enables/disables alarm code output.
Analog Speed Limiting Gain	Sets the speed limit for 1 V of analog input voltage.
Analog Speed Limit Clamp	Sets the speed at which the analog speed limit is clamped to zero.
Analog Speed Limit Offset Voltage	Sets the offset voltage for analog speed limit input.
Analog Torque Command Gain	Sets the torque command for 1 V of analog input voltage.
Analog Torque Command Offset Voltage	Sets the offset voltage for analog torque command input.
Analog Input Signal Automatic Offset	Enables/disables analog input signal automatic offset.
Analog Speed Monitor Max. Value	Sets the max. value for the analog speed monitor. The slope for the analog speed monitor output is decided.
Analog Speed Monitor Max. Voltage	Sets the monitor output voltage for the max. value of the analog speed monitor.
Analog Speed Monitor Offset Voltage	Sets the offset voltage for the analog speed monitor.
Analog Torque Monitor Max. Value	Sets the max. value for the analog torque monitor. The slope for the analog torque monitor output is decided.
Analog Torque Monitor Max. Voltage	Sets the monitor output voltage for the max. value of the analog torque monitor.
Analog Torque Monitor Offset Voltage	Sets the offset voltage for analog torque monitor.
Overvoltage Warning	Sets the voltage at which an overvoltage warning is issued.
Undervoltage Warning	Sets the voltage at which a undervoltage warning is issued.
Overheat Warning	Sets the temperature at which an overheat warning is issued.
Overload Warning	Sets the condition for which an overload warning is issued.
Overspeed Warning	Sets the speed at which an overspeed warning is issued.
Gear Ratio for Speed Monitor	Sets the geared motor gear ratio for speed monitor.

● Tension Control Mode

◇ Operating Data

Item	Content
Tension Command	Sets the tension command. 100% is the rated torque.
Material Thickness <sup>*1*</sup> <sup>*2</sup>	Sets the material thickness.
Initial Diameter <sup>*1*</sup> <sup>*2</sup>	Sets the initial diameter for winding or winding out.
Final Diameter <sup>*1*</sup> <sup>*2</sup>	Sets the final diameter for winding or winding out.
Taper Setting <sup>*1*</sup> <sup>*2</sup>	This function prevents winding drawing. As the winding diameter increases, the tension is adjusted lower. When it is 100%, the tension becomes constant.
Core Inertia <sup>*2</sup>	Sets the core inertial moment.
Material Inertia <sup>*2</sup>	Sets the material inertial moment for the max. material diameter.
Speed Limit	Sets the speed limiting value.

\*1 Set in high function mode I.

\*2 Set in high function mode II.

◇ System Parameters

Item	Content
Encoder Output Electronic Gear A	Sets the electronic gear denominator for encoder output.
Encoder Output Electronic Gear B	Sets the electronic gear numerator for encoder output.
Tension Control Mode Selection	Sets the operating mode.
Tension Control Gear Ratio	Sets the gear ratio from the motor shaft to the winding shaft.
Analog Input Signal	Enables/disables analog input signals.
Motor Rotation Direction	Sets the torque direction.
Control Module Initial Display	Selects the initial display for when communications start between the control module and the driver. If an item is selected that is not displayed in tension control mode, the monitor mode top screen becomes the initial display.

◇ Application Parameters

Item	Content
Output Signal Selection 1	Selects the output signal.
Output Signal Selection 2	Selects the output signal.
Zero Speed Output Range	Sets the ZV output conditions.
MOVE Signal Min. ON Time	Sets the min. duration that MOVE output is ON.
Alarm Code Output	Enables/disables output.
Analog Speed Limiting Gain	Sets the speed limit for 1 V of analog input voltage.
Analog Speed Limit Clamp	Sets the speed at which the analog speed limit is clamped to zero.
Analog Speed Limit Offset Voltage	Sets the offset voltage for analog speed limit input.
Analog Tension Command Gain	Sets the tension command for 1 V of analog input voltage.
Analog Tension Command Offset Voltage	Sets the offset voltage for analog tension command input.
Analog Input Signal Automatic Offset	Enables/disables analog input signal automatic offset.
Analog Speed Monitor Max. Value	Sets the max. value for the analog speed monitor. The slope for the analog speed monitor output is decided.
Analog Speed Monitor Max. Voltage	Sets the monitor output voltage for the max. value of the analog speed monitor.
Analog Speed Monitor Offset Voltage	Sets the offset voltage for the analog speed monitor.
Analog Torque Monitor Max. Value	Sets the max. value for the analog torque monitor. The slope for the analog torque monitor output is decided.
Analog Torque Monitor Max. Voltage	Sets the monitor output voltage for the max. value of the analog torque monitor.
Analog Torque Monitor Offset Voltage	Sets the offset voltage for analog torque monitor.
Acceleration/Deceleration Correction Filter <sup>*2</sup>	Sets the acceleration/deceleration correction filter time constant. If the winding operation vibrates during acceleration/deceleration, set this value larger.
Friction Torque Correction <sup>*1*</sup> <sup>*2</sup>	Sets the friction torque correction. Corrects the torque load for the friction in the mechanism. The value of the torque detected during idling.
Overvoltage Warning	Sets the voltage at which an overvoltage warning is issued.
Undervoltage Warning	Sets the voltage at which an undervoltage warning is issued.
Overheat Warning	Sets the temperature at which an overheat warning is issued.
Overload Warning	Sets the condition for which an overload warning is issued.
Overspeed Warning	Sets the speed at which an overspeed warning is issued.
Gear Ratio for Speed Monitor	Sets the geared motor gear ratio for speed monitor.

\*1 Set in high function mode I.

\*2 Set in high function mode II.

Servo Motors

# Accessories

	<u>Page</u>
Cables.....	B-48
Flexible Couplings .....	B-52
Control Module .....	B-55
Data Setting Software .....	B-55
Accessory Sets.....	B-56
Battery .....	B-56
Regeneration Units .....	B-57

Introduction

**NX**

Accessories

Accessories

# Cables

## 1 Connection Cable Sets (RoHS) Flexible Connection Cable Sets (RoHS)

## 2 Extension Cable Sets (RoHS) Flexible Extension Cable Sets (RoHS)

The **NX** Series comes with cables of 3 m (9.8 ft.) for the connection between the motor and driver. When the distance between the motor and driver is extended longer than 3 m (9.8 ft.), a connection cable set or extension cable set must be used. Use a flexible extension cable if the cable will be bent repeatedly.

### Cable System Configuration

#### When Connecting the Motor and Driver without Using the Included Cables

Use a connection cable set or use a flexible connection cable set if the cables will be bent.

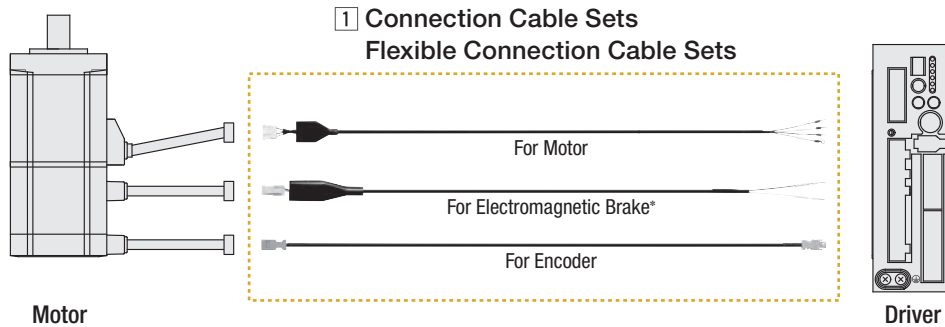

#### When Extending the Distance between the Motor and the Driver Using Included Cables

Use an extension cable set and connect it to the included cables, or use a flexible extension cable set added if the cables will be bent.

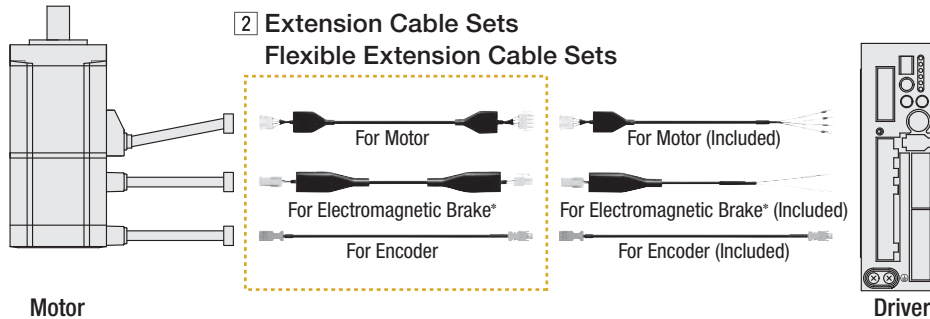

\*Cables for electromagnetic brake are for use when using electromagnetic brake type motors.

**Note**

● Keep the overall cable length 20 m (65.6 ft.) max. when using an extension cable set or a flexible extension cable set to connect with cables included with the **NX** Series.

### Note on Use of Flexible Cables

① Do not allow the cable to bend at the cable connector.

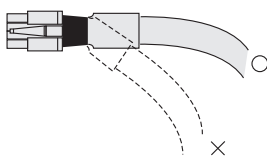

② For the bending radius, use 6 times min. of the cable diameter.

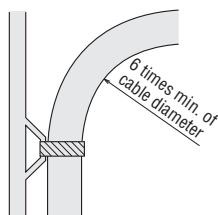

③ The connection cable is not for bending. If the cable is to be bent, bend it at the flexible connection cable.

#### Flexible Connection Cable

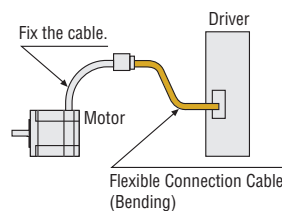

#### Flexible Extension Cable

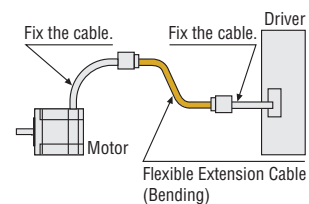



## 1 Connection Cable Sets RoHS

### Flexible Connection Cable Sets RoHS

#### Product Line

##### ● Connection Cable Sets

###### ◇ For Standard Type Motor



Model	Length L m (ft.)
<b>CC010VNF</b>	1 (3.3)
<b>CC020VNF</b>	2 (6.6)
<b>CC030VNF</b>	3 (9.8)
<b>CC050VNF</b>	5 (16.4)
<b>CC070VNF</b>	7 (23)
<b>CC100VNF</b>	10 (32.8)
<b>CC150VNF</b>	15 (49.2)
<b>CC200VNF</b>	20 (65.6)

###### ◇ For Electromagnetic Brake Type Motor



Model	Length L m (ft.)
<b>CC010VNFB</b>	1 (3.3)
<b>CC020VNFB</b>	2 (6.6)
<b>CC030VNFB</b>	3 (9.8)
<b>CC050VNFB</b>	5 (16.4)
<b>CC070VNFB</b>	7 (23)
<b>CC100VNFB</b>	10 (32.8)
<b>CC150VNFB</b>	15 (49.2)
<b>CC200VNFB</b>	20 (65.6)

##### ● Flexible Connection Cable Sets

###### ◇ For Standard Type Motor



Model	Length L m (ft.)
<b>CC010VNR</b>	1 (3.3)
<b>CC020VNR</b>	2 (6.6)
<b>CC030VNR</b>	3 (9.8)
<b>CC050VNR</b>	5 (16.4)
<b>CC070VNR</b>	7 (23)
<b>CC100VNR</b>	10 (32.8)
<b>CC150VNR</b>	15 (49.2)
<b>CC200VNR</b>	20 (65.6)

###### ◇ For Electromagnetic Brake Type Motor

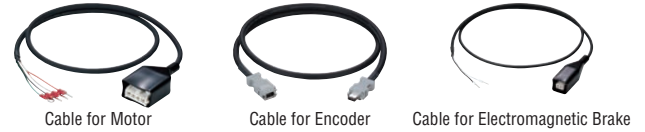

Model	Length L m (ft.)
<b>CC010VNRB</b>	1 (3.3)
<b>CC020VNRB</b>	2 (6.6)
<b>CC030VNRB</b>	3 (9.8)
<b>CC050VNRB</b>	5 (16.4)
<b>CC070VNRB</b>	7 (23)
<b>CC100VNRB</b>	10 (32.8)
<b>CC150VNRB</b>	15 (49.2)
<b>CC200VNRB</b>	20 (65.6)

#### Dimensions Unit = mm (in.)

##### ◇ Cable for Motor

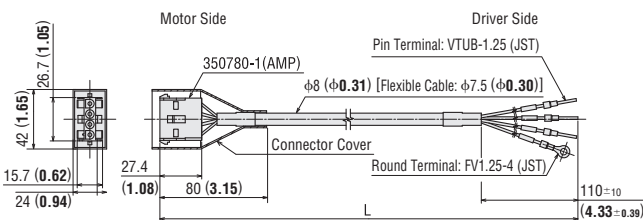

##### ◇ Cable for Encoder

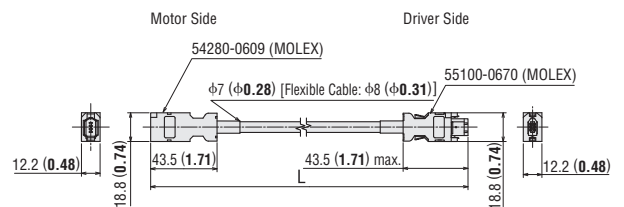

##### ◇ Cable for Electromagnetic Brake

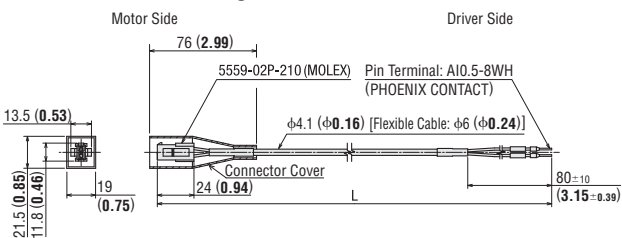

## 2 Extension Cable Sets RoHS

### Flexible Extension Cable Sets RoHS

#### Product Line

##### Extension Cable Sets

###### ◇ For Standard Type Motor

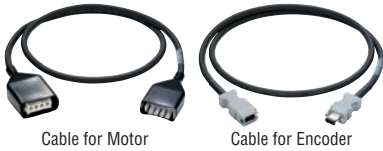

Model	Length L m (ft.)
<b>CC010VNFT</b>	1 (3.3)
<b>CC020VNFT</b>	2 (6.6)
<b>CC030VNFT</b>	3 (9.8)
<b>CC050VNFT</b>	5 (16.4)
<b>CC070VNFT</b>	7 (23)
<b>CC100VNFT</b>	10 (32.8)
<b>CC150VNFT</b>	15 (49.2)

###### ◇ For Electromagnetic Brake Type Motor

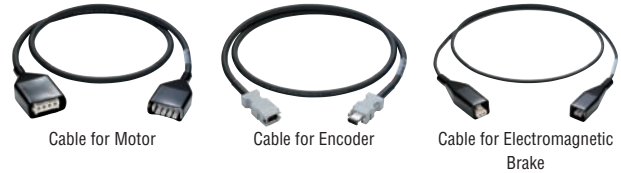

Model	Length L m (ft.)
<b>CC010VNBFT</b>	1 (3.3)
<b>CC020VNBFT</b>	2 (6.6)
<b>CC030VNBFT</b>	3 (9.8)
<b>CC050VNBFT</b>	5 (16.4)
<b>CC070VNBFT</b>	7 (23)
<b>CC100VNBFT</b>	10 (32.8)
<b>CC150VNBFT</b>	15 (49.2)

##### Flexible Extension Cable Sets

###### ◇ For Standard Type Motor

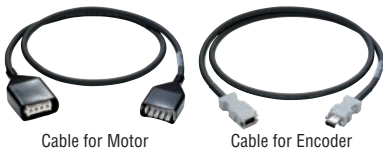

Model	Length L m (ft.)
<b>CC010VNRT</b>	1 (3.3)
<b>CC020VNRT</b>	2 (6.6)
<b>CC030VNRT</b>	3 (9.8)
<b>CC050VNRT</b>	5 (16.4)
<b>CC070VNRT</b>	7 (23)
<b>CC100VNRT</b>	10 (32.8)
<b>CC150VNRT</b>	15 (49.2)

###### ◇ For Electromagnetic Brake Type Motor

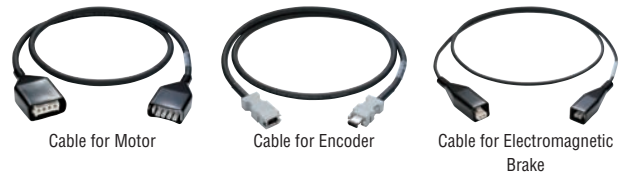

Model	Length L m (ft.)
<b>CC010VNRBT</b>	1 (3.3)
<b>CC020VNRBT</b>	2 (6.6)
<b>CC030VNRBT</b>	3 (9.8)
<b>CC050VNRBT</b>	5 (16.4)
<b>CC070VNRBT</b>	7 (23)
<b>CC100VNRBT</b>	10 (32.8)
<b>CC150VNRBT</b>	15 (49.2)

#### Dimensions Unit = mm (in.)

##### ◇ Cable for Motor

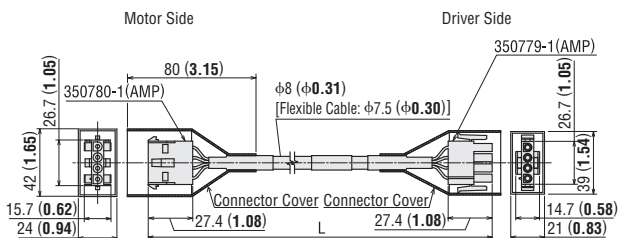

##### ◇ Cable for Encoder

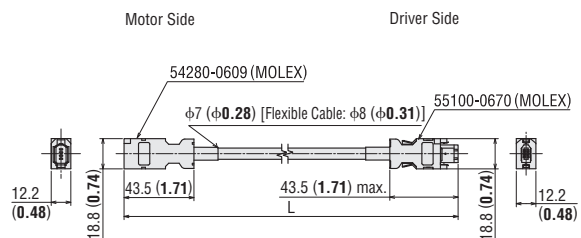

##### ◇ Cable for Electromagnetic Brake

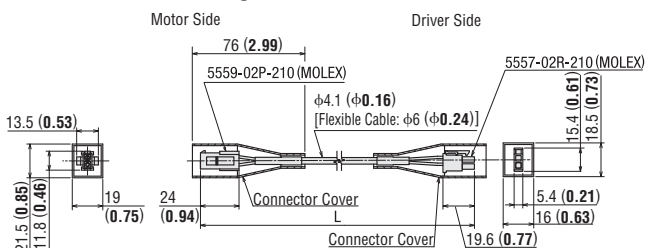

# Driver Cables

## General-Purpose Cables RoHS

These shielded cables have a half-pitch connector at one end of the cable for easy connection to the driver.



### Dimensions Unit = mm (in.)

#### CC36D1-1, CC36D2-1

Conductor: AWG28

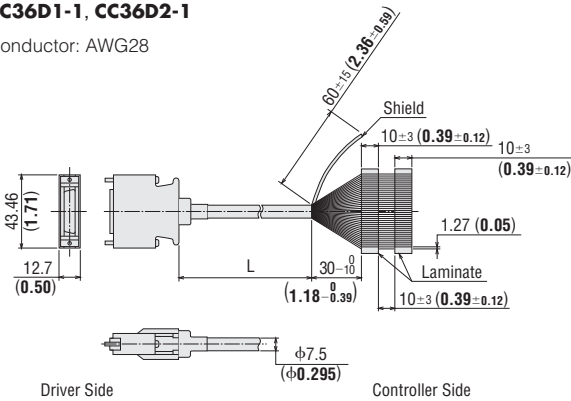

### Product Line

Model	Applicable	Length L m (ft.)
CC36D1-1	For CN7 (36 pins)	1 (3.3)
CC36D2-1		2 (6.6)
CC20D1-1	For CN6 (20 pins)	1 (3.3)
CC20D2-1		2 (6.6)

#### Notes

- Note that as the length of the pulse line between the driver and controller increases, the maximum frequency decreases.
- Install a connector that matches the controller you are using to the other end of the cable.

#### CC20D1-1, CC20D2-1

Conductor: AWG28

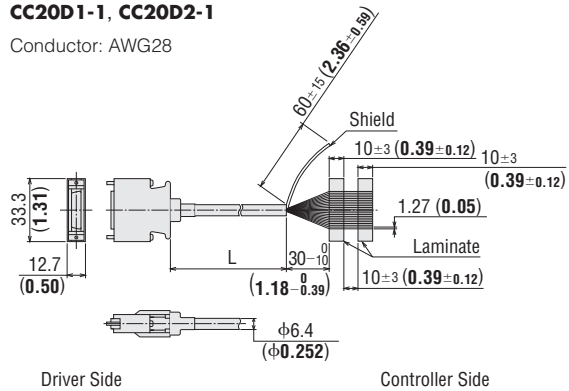

## Connector – Terminal Block Conversion Units RoHS

These are conversion units that connect a driver to a programmable controller using a terminal block.

- Include a signal name plate for easy, one-glance identification of driver signal names
- DIN rail installable
- Cable length: 1 m (3.3 ft.)



### Product Line

Model	Applicable	Length L m (ft.)
CC36T1	For CN7 (36 pins)	1 (3.3)
CC20T1	For CN6 (20 pins)	

#### CC20T1

DXF B437

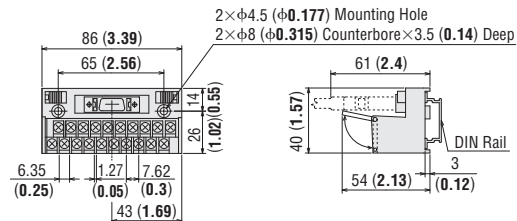

### Dimensions Unit = mm (in.)

#### CC36T1

DXF B438

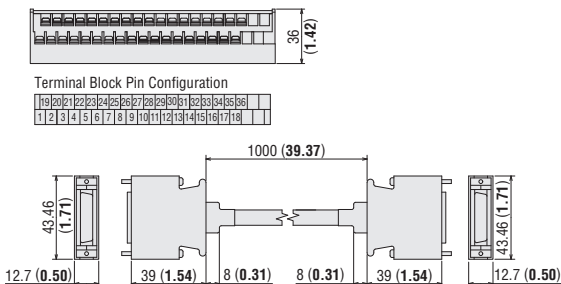
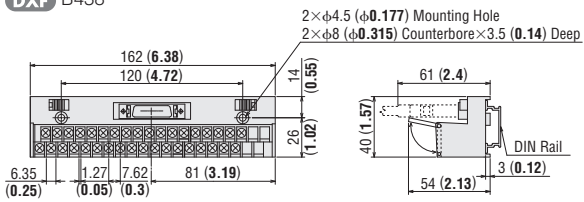

#### Terminal Block Pin Configuration

11	12	13	14	15	16	17	18	19	20
1	2	3	4	5	6	7	8	9	10

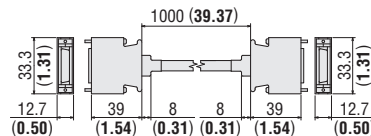

- Applicable Crimp Terminal
- Terminal screw size: M3
- Tightening torque: 1.2 N·m (170 oz-in.)
- Applicable min. lead wire: AWG22

#### Note

- Round terminals cannot be used.

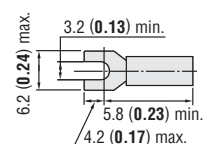

# Flexible Couplings

## MCV Couplings RoHS

### Features

- Compatible with servo motors, which support low resonance and high gain
- Anti-vibration rubber absorbs vibration generated by the motor
- High response
- Non-backlash
- Electrical insulation



### Product Number Code

# MCV 30 08 14

①      ②      ③      ④

①	MCV Coupling
②	Outer Diameter Dimension of Coupling
③	Inner Diameter d1 (Smaller inner diameter)
④	Inner Diameter d2 (Larger inner diameter)

- For inner diameter d1, the smaller of the motor shaft diameter or the driven shaft diameter is entered.
- For inner diameter d2, the larger of the motor shaft diameter or the driven shaft diameter is entered.

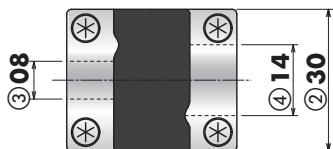

### Product Line

Model
MCV19□
MCV25□
MCV30□
MCV34□
MCV39□

- A number indicating the coupling inner diameter is entered where the box □ is located within the product name.

### Selecting a Coupling

The following examples explain the procedure for selecting a coupling by driven shaft diameter and motor and driver package name.

Example: Motor/Driver Package Name: **NX620AA-3**      Driven shaft diameter:  $\phi 8$  ( $\phi 0.3150$  in.)

1. The coupling type that matches **NX620AA-3** from the coupling selection table is **MCV30**.
  2. The inner diameter of the coupling according to the motor shaft diameter will be **14** [ $\phi 14$  ( $\phi 0.5512$  in.)], and will be **8** [ $\phi 8$  ( $\phi 0.3150$  in.)] according to the driven shaft diameter.
  3. In the coupling product name, smaller inner diameters come before larger ones and thus the coupling product name will be **MCV300814**.
- When the inner diameter is  $\phi 6.35$  ( $\phi 0.2500$  in.), the number is **06A**.

### Coupling Selection Table

Applicable Products			Type	Motor Shaft Diameter mm (in.)	Driven Shaft Diameter mm (in.)									
Type	Frame Size mm (in.)	Model			05	06	06A	08	10	12	14	15	16	
					$\phi 5$ ( $\phi 0.1969$ )	$\phi 6$ ( $\phi 0.2362$ )	$\phi 6.35$ ( $\phi 0.2500$ )	$\phi 8$ ( $\phi 0.3150$ )	$\phi 10$ ( $\phi 0.3937$ )	$\phi 12$ ( $\phi 0.4724$ )	$\phi 14$ ( $\phi 0.5512$ )	$\phi 15$ ( $\phi 0.5906$ )	$\phi 16$ ( $\phi 0.6299$ )	
Standard Type	42 (1.65)	<b>NX45</b> <b>NX410</b>	<b>MCV19</b>	<b>8</b>	$\phi 8$ ( $\phi 0.3150$ )	●	●		●					
	60 (2.36)	<b>NX620</b> <b>NX640</b>	<b>MCV30</b>	<b>14</b>	$\phi 14$ ( $\phi 0.5512$ )				●	●	●	●	●	
	85 (3.35)	<b>NX975</b>	<b>MCV39</b>	<b>16</b>	$\phi 16$ ( $\phi 0.6299$ )					●	●	●	●	●

- The applicable products are listed such that the series name can be determined.

## Specifications

Model	Dimensions				Screw Used	Normal Torque	Maximum Torque*1	Mass	Inertia*2	Static Torsion Spring Constant	Permissible Eccentricity	Permissible Declination	Permissible Endplay
	Outer Diameter	Length	Shaft Hole Diameter d1	Shaft Hole Diameter d2									
	mm (in.)	mm (in.)	mm (in.)	mm (in.)		N-m (lb-in)	N-m (lb-in)	g (oz.)	kg-m <sup>2</sup> (lb-in <sup>2</sup> )	N-m/rad (lb-in/rad)	mm (in.)	deg	mm (in.)
<b>MCV190508</b>	19 (0.75)	26 (1.02)	5 (0.1969)	8 (0.3150)	M2	2.1 (18.5)	4.2 (37)	14 (0.49)	8.4×10 <sup>-7</sup> (0.046)	88 (770)	0.15 (0.0059)	1.5	±0.2 (±0.0079)
<b>MCV190608</b>			6 (0.2362)	8 (0.3150)									
<b>MCV190808</b>			8 (0.3150)	8 (0.3150)									
<b>MCV250508</b>	25 (0.98)	32 (1.26)	5 (0.1969)	8 (0.3150)	M2.5	4.0 (35)	8.0 (70)	28 (0.98)	30×10 <sup>-7</sup> (0.164)	170 (1500)	0.15 (0.0059)	1.5	±0.2 (±0.0079)
<b>MCV250608</b>			6 (0.2362)	8 (0.3150)									
<b>MCV250610</b>			6 (0.2362)	10 (0.3937)									
<b>MCV2506A08</b>			6.35 (0.2500)	8 (0.3150)									
<b>MCV2506A10</b>			6.35 (0.2500)	10 (0.3937)									
<b>MCV250808</b>			8 (0.3150)	8 (0.3150)									
<b>MCV250810</b>			8 (0.3150)	10 (0.3937)									
<b>MCV250812</b>			8 (0.3150)	12 (0.4724)									
<b>MCV251010</b>			10 (0.3937)	10 (0.3937)									
<b>MCV251012</b>			10 (0.3937)	12 (0.4724)									
<b>MCV300808</b>	30 (1.18)	36 (1.42)	8 (0.3150)	8 (0.3150)	M3	6.3 (55)	12.6 (111)	45 (1.59)	69×10 <sup>-7</sup> (0.38)	220 (1940)	0.20 (0.0079)	1.5	±0.3 (±0.0118)
<b>MCV300810</b>			8 (0.3150)	10 (0.3937)									
<b>MCV300812</b>			8 (0.3150)	12 (0.4724)									
<b>MCV300814</b>			8 (0.3150)	14 (0.5512)									
<b>MCV300815</b>			8 (0.3150)	15 (0.5906)									
<b>MCV301010</b>			10 (0.3937)	10 (0.3937)									
<b>MCV301012</b>			10 (0.3937)	12 (0.4724)									
<b>MCV301014</b>			10 (0.3937)	14 (0.5512)									
<b>MCV301015</b>			10 (0.3937)	15 (0.5906)									
<b>MCV301214</b>			12 (0.4724)	14 (0.5512)									
<b>MCV301414</b>			14 (0.5512)	14 (0.5512)									
<b>MCV301415</b>			14 (0.5512)	15 (0.5906)									
<b>MCV340814</b>			34 (1.34)	38 (1.50)									
<b>MCV341014</b>	10 (0.3937)	14 (0.5512)											
<b>MCV341214</b>	12 (0.4724)	14 (0.5512)											
<b>MCV341414</b>	14 (0.5512)	14 (0.5512)											
<b>MCV341415</b>	14 (0.5512)	15 (0.5906)											
<b>MCV341416</b>	14 (0.5512)	16 (0.6299)											
<b>MCV391014</b>	39 (1.54)	48 (1.89)	10 (0.3937)	14 (0.5512)	M4	13.5 (119)	27.0 (230)	98 (3.4)	270×10 <sup>-7</sup> (1.48)	520 (4600)	0.20 (0.0079)	1.5	±0.3 (±0.0118)
<b>MCV391016</b>			10 (0.3937)	16 (0.6299)									
<b>MCV391214</b>			12 (0.4724)	14 (0.5512)									
<b>MCV391216</b>			12 (0.4724)	16 (0.6299)									
<b>MCV391414</b>			14 (0.5512)	14 (0.5512)									
<b>MCV391415</b>			14 (0.5512)	15 (0.5906)									
<b>MCV391416</b>			14 (0.5512)	16 (0.6299)									
<b>MCV391516</b>			15 (0.5906)	16 (0.6299)									
<b>MCV391616</b>	16 (0.6299)	16 (0.6299)											

\*1 Take the maximum torque into consideration when the limited duty region of the AC servo motor is being used.

\*2 The inertia is the value at the maximum shaft hole diameter.

## Temperature Correction Factor

Operating Ambient Temperature	-20 to +30°C (-4 to +86°F)	+30 to +40°C (+86 to +104°F)	+40 to +50°C (+104 to +122°F)
Temperature Correction Factor	1.00	0.80	0.70

● If the operating ambient temperature exceeds 30°C (86°F), correct the maximum torque with the temperature correction factor.

**Dimensions** Unit = mm (in.)

**MCV19**

Mass: 14 g (0.49 oz.)

**DXF** B550

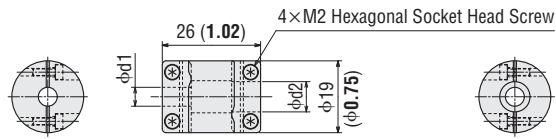

**MCV25**

Mass: 28 g (0.98 oz.)

**DXF** B551

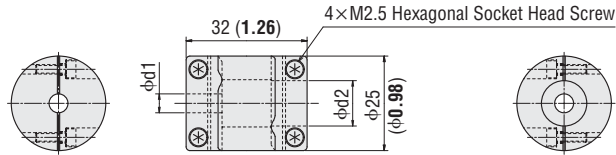

**MCV30**

Mass: 45 g (1.59 oz.)

**DXF** B552

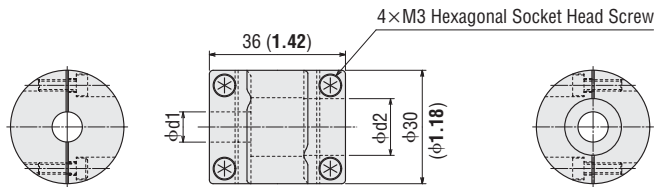

**MCV34**

Mass: 65 g (2.2 oz.)

**DXF** B553

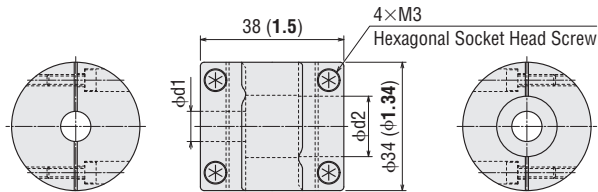

**MCV39**

Mass: 98 g (3.4 oz.)

**DXF** B554

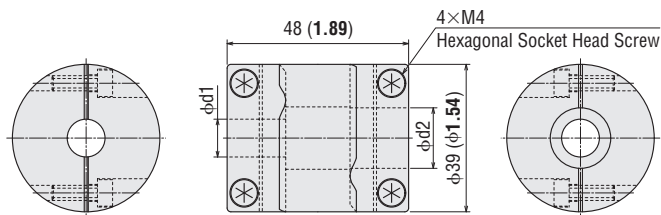

## Control Module RoHS

For use with the **NX** Series extended functions. Makes it possible to change parameters, add functions, etc.

### Product Line

Model
<b>OPX-2A</b>

### Specifications

Indication	LED
Cable Length	5 m (16.4 ft.)
Operating Ambient Temperature	0 to +40°C (+32 to +104°F) (non-freezing)



### Dimensions Unit = mm (in.)

#### Control Module

Mass: 0.25 kg (8.8 oz.)

**DXF** B453

#### Panel Cut-Out for Control Module

[Thickness of the mounting plate: 1~3 mm (0.04~0.12 in.)]

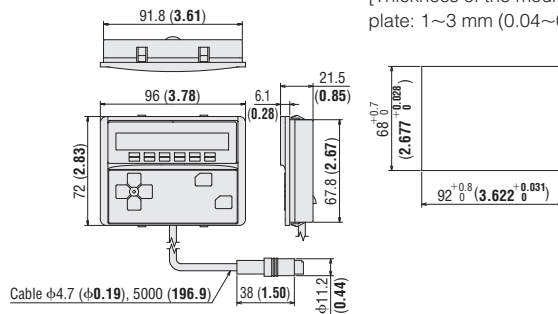

## Data Setting Software RoHS

For use with the **NX** Series extended functions. Allows to change parameters, add functions, use waveform monitoring to confirm the operation etc. with a computer.



### Product Line

Model
<b>MEXE02</b>

● 5 m (1.64 ft.) PC interface cable, 0.5 m (20 in.) USB cable included

### Connection between Computer and Driver

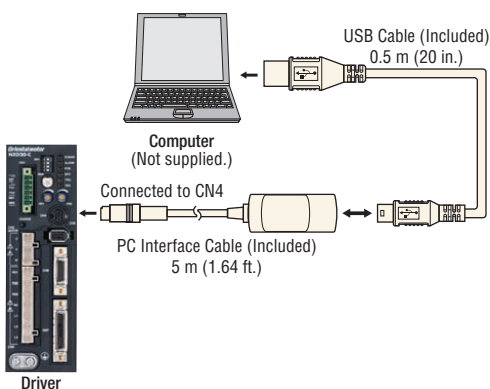

### Operating Environment

Operating Systems	The OS supports 32-bit (x86) and 64-bit (x64) versions only. Windows® 2000 Professional Service Pack 4 or later* <sup>1</sup> Windows® XP Home Edition Service Pack 3 or later Windows® XP Professional Service Pack 2 Windows® XP Professional Service Pack 3* <sup>2</sup> or later Windows® Vista Home Basic Service Pack 2 or later Windows® Vista Home Premium Service Pack 2 or later Windows® Vista Business Service Pack 2 or later Windows® Vista Ultimate Service Pack 2 or later Windows® Vista Enterprise Service Pack 2 or later Windows® 7 Starter Service Pack 1 or later Windows® 7 Home Premium Service Pack 1 or later Windows® 7 Professional Service Pack 1 or later Windows® 7 Ultimate Service Pack 1 or later Windows® 7 Enterprise Service Pack 1 or later
CPU* <sup>3</sup>	Intel Core Processor 2 GHz or more (The OS must be supported.)
Memory* <sup>3</sup>	32-bit (x86) version: 1 GB or more 64-bit (x64) version: 2 GB or more
Hard Disk* <sup>4</sup>	Available disk space of 30 MB or more
Disk Device	CD-ROM drive
Serial Interface	USB 1.1 1 port

- \*1 Rollup 1 must be applied.
  - \*2 Service Pack 3 supports 32-bit (x86) version only.
  - \*3 The OS operating conditions must be satisfied.
  - \*4 Microsoft NET framework 2.0 Service Pack 2 is required to use **MEXE02**. If it is not already installed, it will be installed automatically, in which case up to 500 MB in additional space is required.
- Windows and Windows Vista are registered trademark of Microsoft Corporation in the United States and other countries. Pentium is a trademark of Intel Corporation.

# Accessory Sets RoHS

When using analog I/O, purchase an accessory set.

## Product Line

Model	Applicable
<b>AS-SV2</b>	20-Pin Connector for CN6 × 1 Set, External Potentiometers × 2 Sets (Potentiometer × 2, Scale plate × 2, Insulation sheet × 2, Knob × 2, Shielded cable × 2)
<b>AS-SD1</b>	20-Pin Connector for CN6 × 1 set



**AS-SV2**



**AS-SD1**

# Battery RoHS

This battery is for constructing an absolute system. Position information can be stored during power blackouts or if the driver's power supply is switched OFF.

## Product Line

Model
<b>BAT01A</b>

## Specifications

Battery Type	Thionyl Chloride Lithium Battery
Nominal Voltage	3.6 V
Rated Capacity	1700 mAh
Mass	25 g (0.88 oz.)
Expected Life	About 4 years*
Data Retention Period	2 years*
Operating Ambient Temperature	0 to +50°C (+32 to +122°F) (non-freezing)
Operating Ambient Humidity	85% or less (non-condensing)
Storage Temperature/ Transportation Temperature	+5 to +35°C (+41 to +95°F) (non-freezing)
Storage Humidity/ Transportation Humidity	70% or less (non-condensing)

\*When the ambient temperature is 20°C (68°F)



With the battery installed on an **NX** Series driver



# Regeneration Units RoHS

Sometimes the regenerative power generated by the motor exceeds the driver's regenerative power absorption capacity. In such a case, a regeneration unit is connected to the driver to release the regenerative power.



Conditions under which a regeneration unit may be required:

- When using for vertical operation
- During acceleration and deceleration time when an inertial load is installed

## Product Line

Model	Applicable Product Name
<b>RGB100</b>	<b>NX45, NX410, NX65, NX610, NX620, NX920</b>
<b>RGB200</b>	<b>NX640, NX940, NX975, NX1075</b>

● The applicable products are listed such that the product name can be determined.

## Dimensions Unit = mm (in.)

### ● RGB100

Mass: 0.25 kg (8.8 oz.)

**DXF** C194

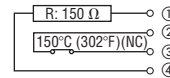
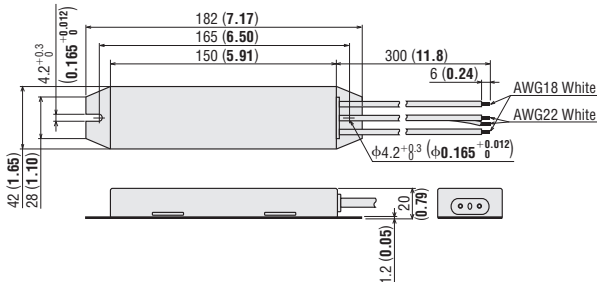

- ①-④ : AWG18×2  
For regeneration current  
Connect to RG Terminal
- ②-③ : AWG22×2  
This is the thermostat output.  
When an abnormality has been detected, cut off the power supply side with the thermostat contact.

### ● RGB200

Mass: 1.1 kg (2.42 lb.)

**DXF** C225

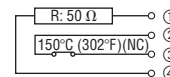
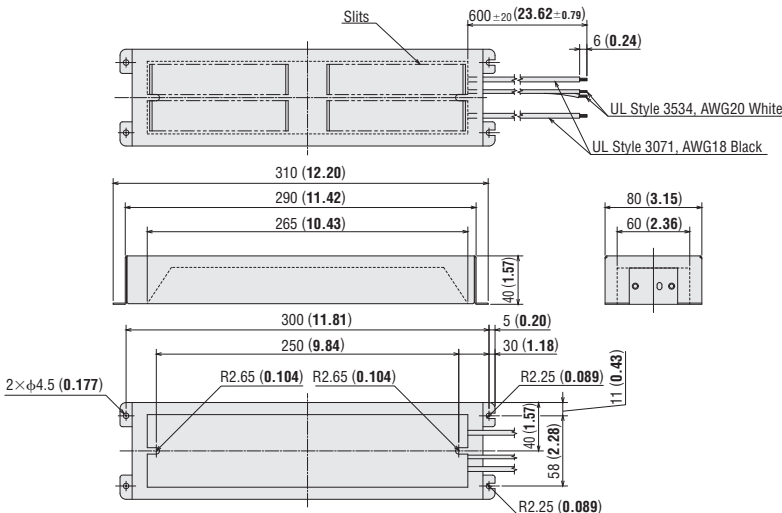

- ①-④ : AWG18×2  
For regeneration current  
Connect to RG Terminal
- ②-③ : AWG20×2  
This is the thermostat output.  
When an abnormality has been detected, cut off the power supply side with the thermostat contact.