



Brushless Motor

BMU Series

30 W / 60 W / 120 W

OPERATING MANUAL



Thank you for purchasing an Oriental Motor product.

This Operating Manual describes product handling procedures and safety precautions.

- Please read it thoroughly to ensure safe operation.
- Always keep the manual where it is readily available.



Only qualified and educated personnel should work with the product.
 Use the product correctly after thoroughly reading the section "1 Safety precautions."
 The items under **Note** contain important handling instructions that the user should observe to ensure safe use of the product. **Note** is described in the related handling items.

The product described in this manual has been designed and manufactured to be incorporated in general industrial equipment. Do not use for any other purpose. Oriental Motor Co., Ltd. is not responsible for any damage caused through failure to observe this warning.

Table of contents



1	Safety precautions	3	7	Convenient functions	23
2	Precautions for use	5	7.1	Functions list	23
3	Preparation	6	7.2	Setting items and panel displays.....	24
3.1	Checking the product	6	7.3	Parameter list	26
3.2	How to identify the product model.....	6	7.4	Items displayed on the driver	28
3.3	Products possible to combine	7	7.5	Setting the operation data	29
3.4	Names and functions of parts	7	7.6	Setting the acceleration time and deceleration time.....	30
4	Installation.....	8	7.7	Data locking for the set data	31
4.1	Installation location.....	8	7.8	Limiting the setting range of the rotation speed	31
4.2	Installing the driver	8	7.9	Holding a load at motor standstill	32
5	Connection.....	10	8	Alarms and warnings	32
5.1	Connecting the motor and driver.....	10	8.1	Alarms	32
* 5.2	Grounding	12	8.2	Warnings	35
5.3	Connecting the power supply.....	13	9	Troubleshooting and remedial actions	36
5.4	Connecting the I/O signals	14	10	Inspection	37
5.5	Connection diagram	15	11	Accessories (sold separately).....	38
6	Operating	17	12	Reference	39
6.1	Operation overview	17	12.1	Standard and CE Marking.....	39
6.2	Operating by front panel.....	17	12.2	Installing and wiring in compliance with EMC Directive	40
6.3	Operating by programmable controller	19	12.3	Specifications	42
			12.4	Pin assignment.....	43

* Be sure to ground the protective earth terminal (⊕) (ground terminal) to ensure the safe use of the product.

Refer to "5.2 Grounding" for details, and ground securely.

1 Safety precautions

The precautions described below are intended to prevent danger or injury to the user and other personnel through safe, correct use of the product. Please read and understand these precautions thoroughly before using the product.

 Warning	Handling the product without observing the instructions that accompany a “Warning” symbol may result in serious injury or death.
 Caution	Handling the product without observing the instructions that accompany a “Caution” symbol may result in injury or property damage.

Warning

General

- Do not use the product in explosive or corrosive environments, in the presence of flammable gases or near combustibles. Doing so may result in fire, electric shock or injury.
- Only qualified and educated personnel should be allowed to perform installation, connection, operation and inspection/troubleshooting of the product. Handling by unqualified and uneducated personnel may result in fire, electric shock, injury or equipment damage.
- Do not transport, install the product, perform connections or inspections when the power is on. Always turn the power off before carrying out these operations. Failure to do so may result in electric shock or equipment damage.
- The terminals on the driver marked with  symbol indicate the presence of high voltage. Do not touch these terminals while the power is on. Doing so may result in fire or electric shock.
- Do not use a motor in a vertical application. If the driver’s protection function is activated, the motor will stop and the moving part of the equipment will drop, thereby causing injury or equipment damage.
- If the driver protective function was activated, remove the cause and reset the protective function. Continuing the operation without removing the cause of the problem may result in malfunction of the motor and driver, leading to injury or damage to equipment.

Installation

- The motor and driver are Class I equipment. When installing the motor and driver, connect their Protective Earth Terminals. Failure to do so may result in electric shock.

Connection

- Securely connect and ground in accordance with the connection diagram. Failure to do so may result in fire or electric shock.
- Do not forcibly bend, pull or pinch the cables. Doing so may result in fire or electric shock.
- Do not machine or modify the motor cable or the connection cable. Doing so may result in electric shock or fire.
- Do not apply any excessive force to the motor connector for the connector type. Doing so may result in electric shock or fire.
- Do not remove the connector cap for the connector type until the connection cable is connected so that the O-ring of the connector connection on the motor is not damaged. Doing so may result in electric shock or fire.
- Be sure to observe the specified cable sizes. Use of unspecified cable sizes may result in fire.

Operation

- Use a motor, gearhead, and driver only in the specified combination. An incorrect combination may cause in fire, electric shock or equipment damage.
- Keep the input power voltage of the driver within the specified range. Failure to do so may result in fire or electric shock.

Maintenance and inspection

- Always turn off the power before performing maintenance/inspection. Failure to do so may result in electric shock.
- Do not touch the motor or driver when conducting insulation resistance measurement or dielectric strength test. Accidental contact may result in electric shock.
- Do not touch the connection terminals on the driver immediately (within 1 minute) after the power is turned off. Residual voltage may cause electric shock.
- Regularly check the openings in the driver for accumulated dust. Accumulated dust may cause fire.

Repair, disassembly and modification

- Do not disassemble or modify the motor, gearhead, and driver. Doing so may result in electric shock, injury or equipment damage. Should you require inspection or repair of internal parts, please contact the Oriental Motor branch or sales office from which you purchased the product.

 **Caution**

General

- Do not use the motor, gearhead, and driver beyond the specifications. Doing so may result in fire, electric shock, injury or damage to equipment.
- Do not insert an object into the openings in the driver. Doing so may result in fire, electric shock or injury.
- Do not touch the motor, gearhead, or driver while operating or immediately after stopping. The surface of the motor, gearhead, or driver may be hot, causing a skin burn(s).

Installation

- Do not leave anything around the motor and driver that would obstruct ventilation. Doing so may result in damage to equipment.
- Do not carry the product by holding the output shaft of the motor or the gearhead, as well as any of the cables. Doing so may result in injury.
- Do not touch the motor output shaft with bare hands. Doing so may result in injury.
- When attaching the motor with the gearhead, exercise caution not to pinch your fingers or other parts of your body between the motor and gearhead. Injury may result.
- Securely install the motor and gearhead, and the driver to their respective mounting plates. Inappropriate installation may cause the motor/driver to detach and fall, resulting in injury or equipment damage.
- Provide a cover over the rotating part (output shaft). Failure to do so may result in injury.
- When installing the motor and gearhead in equipment, exercise caution not to pinch your fingers or other parts of your body between the product and equipment. Injury may result.
- Securely install a load on the output shaft. Inappropriate installation may result in injury.

Connection

- Be sure to ground the motor and driver to prevent them from being damaged by static electricity. Failure to do so may result in fire or damage to equipment.
- For the power supply of I/O signals, use a DC power supply with reinforced insulation on its primary and secondary sides. Failure to do so may result in electric shock.

Operation

- Provide an emergency stop device or emergency stop circuit external to the equipment so that the entire equipment will operate safely in the event of a system failure or malfunction. Failure to do so may result in injury.
- Immediately when trouble has occurred, stop running and turn off the driver power. Failure to do so may result in fire, electric shock or injury.
- Do not touch the rotating part (output shaft) when operating the motor. Doing so may result in injury.
- The motor surface temperature may exceed 70 °C (158 °F) even under normal operating conditions. If the operator is allowed to approach a running motor, attach a warning label as shown in the figure in a conspicuous position. Failure to do so may result in skin burn(s).
- Use an insulated screwdriver to adjust the acceleration/deceleration time potentiometer in the driver. Failure to do so may result in electric shock.



Warning label

Disposal

- To dispose of the motor, gearhead, and driver, disassemble it into parts and components as much as possible and dispose of individual parts/components as industrial waste.

■ **Warning information**

A warning label with handling instructions is attached on the driver. Be sure to observe the instructions on the label when handling the driver.

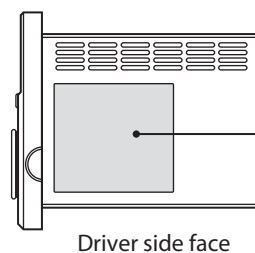

<p>⚠ WARNING – Risk of electric shock. Hot Surface</p> <ul style="list-style-type: none"> • Read manual before installing. • Wait 1 minute for capacitor discharge after disconnecting power supply. • Do not touch the heatsink. Risk of burn. 	
<p>⚠ AVERTISSEMENT – Risque de décharge électrique. Surface chaude</p> <ul style="list-style-type: none"> • Lire le manuel avant l'installation. • Attendre 1 minute après la coupure de l'alimentation, pour permettre la décharge des condensateurs. • Ne pas toucher le dissipateur thermique. Risque de brûlure. 	
<p>⚠ 警告 – けが・感電のおそれがあります。高温注意</p> <ul style="list-style-type: none"> • 取扱い、運転の前には必ず取扱説明書をお読み下さい。 • 通電中及び電源遮断後 1 分以内はドライバに触れないで下さい。残留電圧により感電の原因になります。 • ヒートシンクは高温になります。やけどに注意して下さい。 	

2 Precautions for use

This chapter covers limitations and requirements the user should consider when using the product.

Be sure to match the motor output power with the driver output power.

- **Connect protective devices to the power line**

Connect a circuit breaker or earth leakage breaker to the driver's power line to protect the primary circuit. If an earth leakage breaker is to be installed, use one incorporating high-frequency noise elimination measures. Refer to "Preventing leakage current" below for the selection of protective devices.

- **Do not perform vertical drive (gravitational operation)**

The product will not be able to control the motor speed if an operation that the motor output shaft is externally rotated is performed (vertical drive etc.). Also, if vertical drive is performed, since the inverter primary voltage of the circuit may exceed the permissible range, the protective function may be activated. As a result, the motor may coast to a stop and the load may fall.

- **Do not use a solid-state relay (SSR) to turn on/off the power**

A circuit that turns on/off the power via a solid-state relay (SSR) may damage the motor and driver.

- **Do not conduct the insulation resistance measurement or dielectric strength test with the motor and driver connected**

Conducting the insulation resistance measurement or dielectric strength test with the motor and driver connected may result in damage to the product.

- **Grease measures**

On rare occasions, grease may ooze out from the gearhead. If there is concern over possible environmental damage resulting from the leakage of grease, check for grease stains during regular inspections. Alternatively, install an oil pan or other device to prevent leakage from causing further damage. Oil leakage may lead to problems in the customer's equipment or products.

- **Caution when using under low temperature environment**

When an ambient temperature is low, since the load torque may increase by the oil seal or viscosity increment of grease used in the gearhead, the output torque may decrease or an overload alarm may generate. However, as time passes, the oil seal or grease is warmed up, and the motor can be driven without generating an overload alarm.

- **Preventing leakage current**

Stray capacitance exists between the driver's current-carrying line and other current-carrying lines, the earth and the motor, respectively. A high-frequency current may leak out through such capacitance, having a detrimental effect on the surrounding equipment. The actual leakage current depends on the driver's switching frequency, the length of wiring between the driver and motor, and so on. When connecting an earth leakage breaker, use one of the following products offering resistance against high frequency current:

[Mitsubishi Electric Corporation: NV series]

- **Noise elimination measures**

Provide noise elimination measures to prevent a motor or driver malfunction caused by external noise. For more effective elimination of noise, use a shielded I/O signal cable or attach ferrite cores if a non-shielded cable is used. Refer to p.40 for the noise elimination measures.

- **Connecting the motor and driver**

Be sure to connect the connector type motor and the driver using the dedicated connection cable (sold separately). The maximum distance between the motor and driver is 10.5 m (34.4 ft.), and the connection cables are provided up to 10 m (32.8 ft.). Limit the number of times so that attaching/detaching between the connection cable and the motor or driver will not exceed 100 times.

- **Connection cable**

Do not apply a strong force on the locking lever of the connector for motor connection. Applying a strong force on the locking lever may cause damage.

- **The driver uses semiconductor elements, so be extremely careful when handling them**

Electrostatic discharge can damage the driver.

Be sure to ground the motor and driver to prevent them from being damaged by electric shock or static electricity.

- **Saving data to the non-volatile memory**

The display blinks while pressing the setting dial to set the data or initializing the data (about 5 seconds). Do not turn off the power supply while the display is blinking. Doing so may abort writing the data and cause an EEPROM error alarm to generate. The non-volatile memory can be rewritten approximately 100,000 times.

3 Preparation

3.1 Checking the product

Verify that the items listed below are included.

Report any missing or damaged items to the branch or sales office from which you purchased the product.

- Driver.....1 unit
- CN1 connector (3 pins).....1 pc
- CN4 connector (9 pins).....1 pc
- OPERATING MANUAL(this document)1 copy
- QUICK START GUIDE1 copy

3.2 How to identify the product model

■ Driver

BMUD 60 - C 2

① ② ③ ④

①	Driver type	BMUD: BMU series driver
②	Output power	30: 30 W 60: 60 W 120: 120 W
③	Power supply voltage	A: Single-phase 100-120 V C: Single-phase, Three-phase 200-240 V
④	Reference number	

■ Motor

- Parallel shaft gearhead **GFV** gearhead
Round shaft

BLM 4 60 S H P - 5 A S

① ② ③ ④ ⑤ ⑥ ⑩ ⑪ ⑫

- Right angle Hollow shaft Hypoid gear **JH** gearhead

BLM 5 120 H P K - 5 H 10 S

① ② ③ ⑤ ⑥ ⑦ ⑧ ⑨ ⑩ ⑫

①	Motor type	BLM: Brushless Motor
②	Frame size	2: 60 mm (2.36 in.) 4: 80 mm (3.15 in.) 5: 90 mm (3.54 in.)
③	Output power	30: 30 W 60: 60 W 120: 120 W
④	Motor classification	S
⑤	Motor connection method	H: Connector type Blank: Cable type
⑥	Degree of protection for motor	P: IP66 Blank: IP40
⑦	Combined motor	K: Round shaft type (with key)
⑧	Frame size of combined motor	5: 90 mm (3.54 in.)
⑨	Gearhead type	H: JH gearhead
⑩	Gear ratio • Motor shaft type	Number: Gear ratio of gearhead A: Round shaft type AC: Round shaft type (Shaft flat)
⑪	Gearhead shaft type	Blank: mm shaft type A: Inch shaft type
⑫	Material of output shaft	S: Stainless steel B: Carbon steel

- A code is added to the end of the model name for the product that the motor connector position has been changed.

3.3 Products possible to combine

Products with which drivers can be combined are listed below.

Verify the driver model and the motor model against the model name described on the package label.

Output power	Power supply voltage	Driver model	Motor model *
30 W	Single-phase 100-120 V	BMUD30-A2	BLM230-□□, BLM230HP-□□
	Single-phase, Three-phase 200-240 V	BMUD30-C2	
60 W	Single-phase 100-120 V	BMUD60-A2	BLM260-□□, BLM260HP-□□ BLM460S-□□, BLM460SHP-□□
	Single-phase, Three-phase 200-240 V	BMUD60-C2	
120 W	Single-phase 100-120 V	BMUD120-A2	BLM5120-□□, BLM5120HP-□□ BLM5120HPK-□□□□
	Single-phase, Three-phase 200-240 V	BMUD120-C2	

* □ in the motor model name indicates a code or a number representing the gear ratio, the shaft shape, or the gearhead type.

3.4 Names and functions of parts

Front side When the front panel is attached

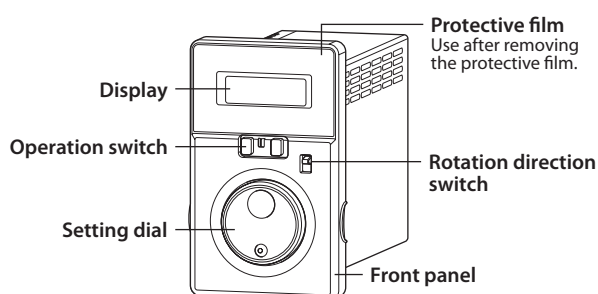

Display	This display shows the monitor item, alarms, etc.
Operation switch	Setting the operation switch to the "RUN" side causes the motor to start running. Setting the operation switch to the "STAND-BY" side causes the motor to stop.
Setting dial	This setting dial is used to change the rotation speed or parameters. After changing, the new value is determined by pressing the setting dial.
Rotation direction switch	This switch is used to change the motor rotation direction.

Front side When the front panel is removed

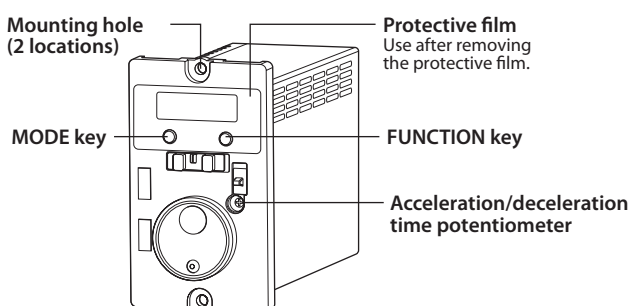

MODE key	This key is used to change the operation mode.
FUNCTION key	This key is used to change the display of the operation mode or the function.
Acceleration/deceleration time potentiometer	This potentiometer is used to set the acceleration/deceleration time.
Mounting hole (2 locations)	Installs the driver with screws (M4 or No.8-32UNC).

Rear side

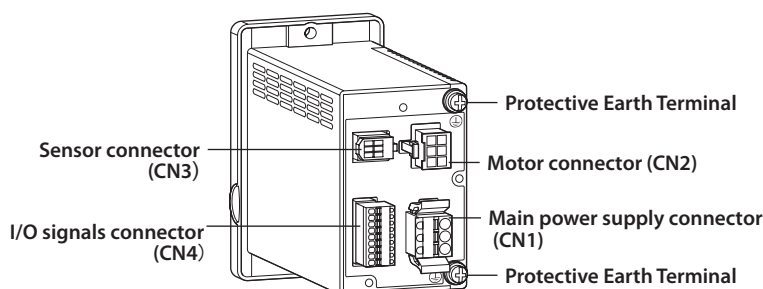

Sensor connector (CN3)	Connects the sensor connector (black) of the motor cable or the connection cable.	Motor connector (CN2)	Connects the power connector (white) of the motor cable or the connection cable.
I/O signals connector (CN4)	Connects the I/O signals.	Main power supply connector (CN1)	Connects the main power supply.
		Protective Earth Terminal ⊕	Connects the ground terminal* of the connection cable and the grounding wire. Be sure to ground the driver using either of the Protective Earth Terminals.

* Connector type only

4 Installation

This chapter explains the installation location and installation methods of the driver.

4.1 Installation location

Install the driver in a well-ventilated place where they can be inspected easily and the following conditions are satisfied:

- Indoors
- Operating ambient temperature: 0 to +40 °C (+32 to +104 °F) (non-freezing)
- Operating ambient humidity: 85% or less (non-condensing)
- Area that is free of explosive atmosphere or toxic gas (such as sulfuric gas) or liquid
- Area not exposed to direct sun
- Area free of excessive amount of dust, iron particles or the like
- Area not subject to splashing water (rain, water droplets), oil (oil droplets) or other liquids
- Area free of excessive salt
- Area not subject to continuous vibration or excessive shocks
- Area free of excessive electromagnetic noise (from welders, power machinery, etc.)
- Area free of radioactive materials, magnetic fields or vacuum
- Altitude Up to 1000 m (3300 ft.) above sea level

4.2 Installing the driver

The driver is designed so that heat is dissipated via air convection and conduction through the enclosure.

There must be a clearance of at least 25 mm (0.98 in.) and 50 mm (1.97 in.) clearances in the horizontal and vertical directions, respectively, between the driver and enclosure or other equipment within the enclosure.

When installing the driver, mount it turning the driver front panel to the front side or upper side.

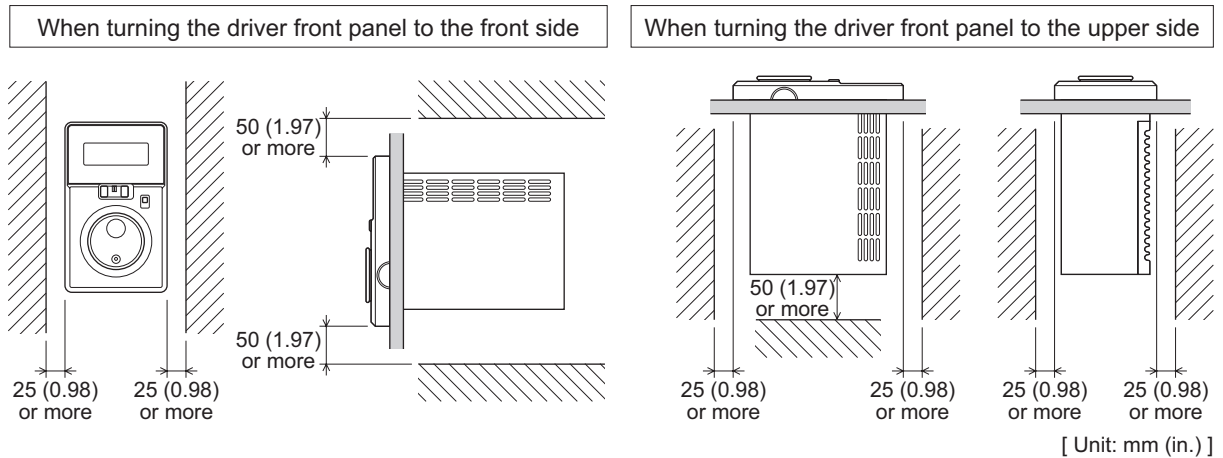

Note

- Do not install any equipment that generates a large amount of heat or noise near the driver.
- If the ambient temperature of the driver exceeds the upper limit of the operating ambient temperature, revise the ventilation condition or forcibly cool the area around the driver using a fan in order to keep within the operating ambient temperature.

■ Installation method

Install the driver to a flat metal plate offering excellent vibration resistance.

Remove the front panel of the driver and secure the two mounting holes using pan head machine screws and nuts (M4 or No.8-32UNC: not supplied).

Tighten the screws until no gaps remain between the driver and mounting plate.

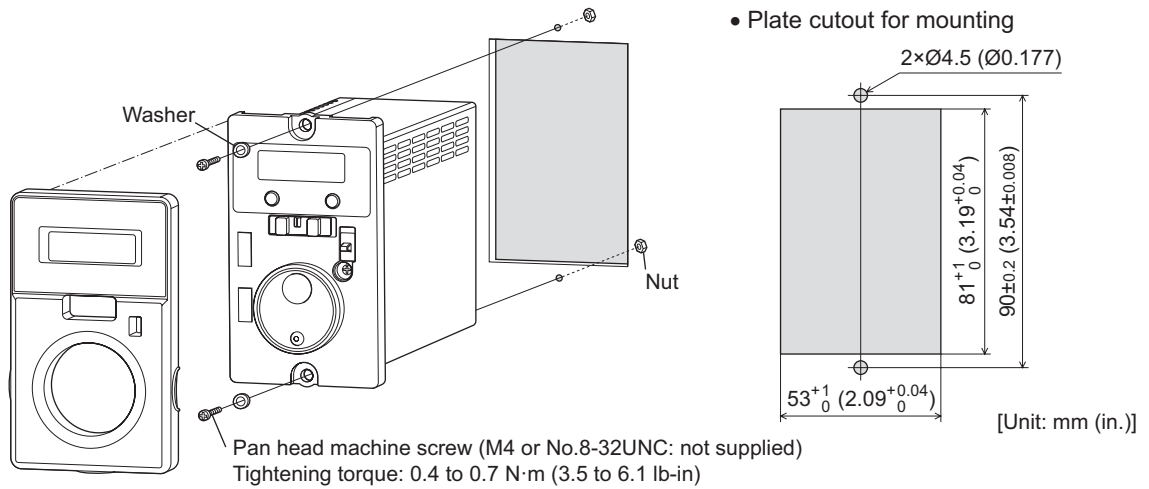

Note

- The space between the mounting hole section and front panel of the driver is 4.5 mm (0.18 in.). Therefore, the total height of the screw head and washer should be less than 4.5 mm (0.18 in.). The front panel cannot be installed if it is exceeded 4.5 mm (0.18 in.).
- If the washer is used, use the washer which outer diameter is 8 mm (0.31 in.) or less.

[Removing and installing the front panel]

Installing

Install the front panel after placing on the upper side of the driver front face.

Removing

Remove the front panel having the under side.

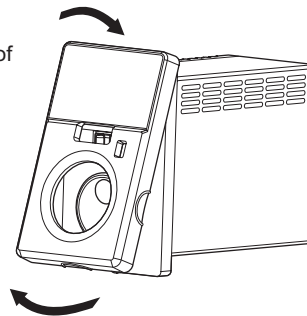

5 Connection

5.1 Connecting the motor and driver

There are the connector type motor and the cable type motor.

■ Connector type

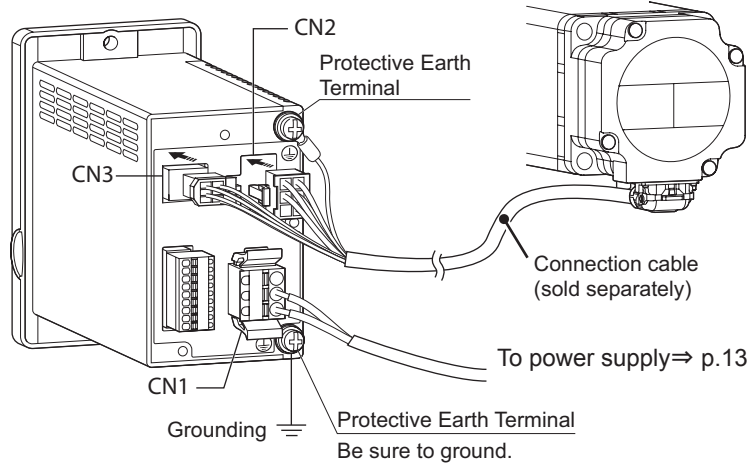

Connect the motor connector (white) of the connection cable to the CN2, and the sensor connector (black) to the CN3 on the driver.

● Connection procedures of the motor and connection cable

Connect the dedicated connection cable (sold separately) to the motor and driver.
The connection cables are provided up to 10 m (32.8 ft.).

[Cable leading direction]

Leading in direction of output shaft

Leading in opposite direction of output shaft

1 Remove

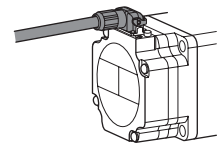
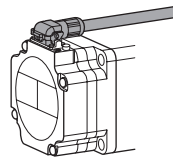
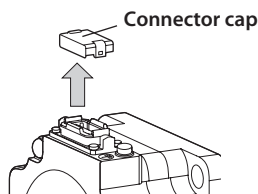

2 Attach

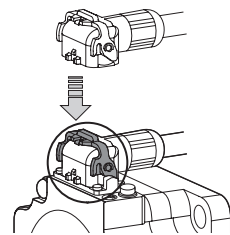

Position of lever

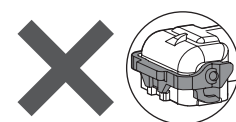
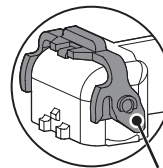

The connector cannot be inserted if the locking lever is turned down.

3 Secure

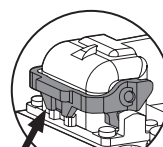
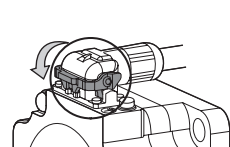

The connector cannot be secured unless the locking lever is turned down.

Be sure to turn down the locking lever till the position shown in the figure.

Note Do not carry the motor by holding the cable. Doing so may cause damage to the product.

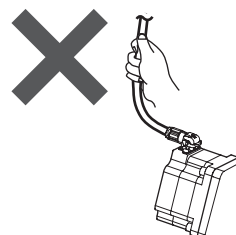

● Detaching the connection cable

If the locking lever is turned up, the cable can be detached.

● Extension between motor and driver

Use a connection cable (accessory) for relay when extending the wiring distance between the motor and driver. The connection cable for relay can be used by connecting up to 2 pieces. The wiring distance between the motor and driver can be extended to a maximum of 10.5 m (34.4 ft.). Refer to p.38 for the connection cable for relay.

Example of use: Example of extension by adding two connection cables [10.5 m (34.4 ft.)]

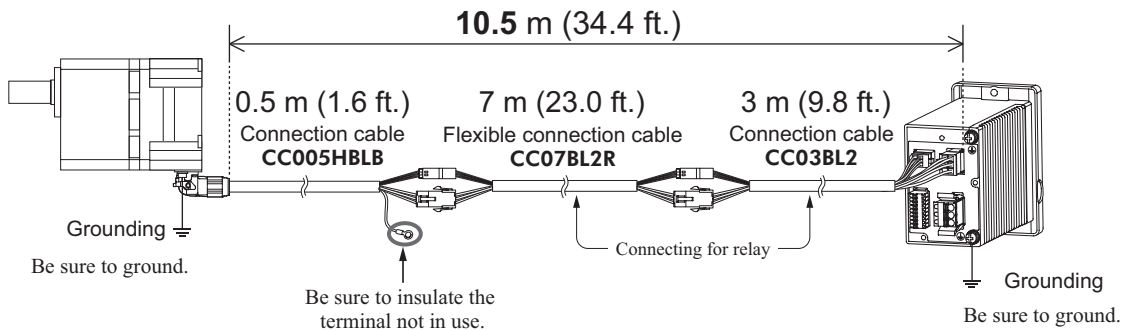

- Note**
- Secure each connectors part not to apply stress on the connectors part. If not secured, the cables may damage by the stress.
 - Securely insert the connector straight. Insecure connections may cause malfunction or damage to the motor or driver.

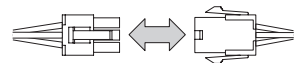

■ Cable type

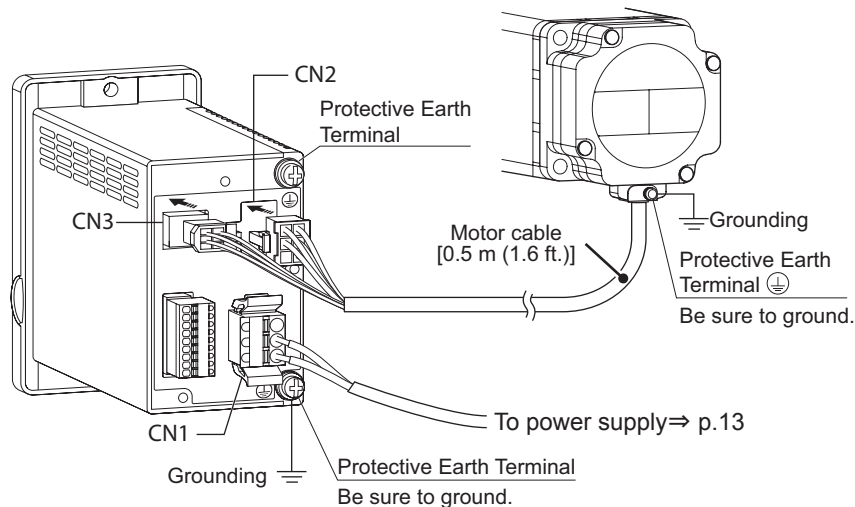

Connect the motor connector (white) of the motor cable to the CN2, and the sensor connector (black) to the CN3 on the driver.

Use a connection cable (accessory) for relay when extending the wiring distance between the motor and driver. The connection cable for relay can be used by connecting up to 2 pieces. The wiring distance between the motor and the driver can be extended up to 10.5 m [34.4 ft.] (including the motor cable). Refer to p.38 for the connection cable for relay.

- Note**
- Secure each connectors part not to apply stress on the connectors part. If not secured, the cables may damage by the stress.
 - Securely insert the connector straight. Insecure connections may cause malfunction or damage to the motor or driver.

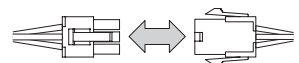

5.2 Grounding

Note Be sure to ground the motor and driver. Failure to do so may result in electric shock or damage to the product. Static electricity may cause damage to the product if the Protective Earth Terminals are not grounded.

■ Connector type

Ground using the Protective Earth Terminals (⊕) of the motor and driver, as well as the ground terminal of the connection cable.

Connect the ground terminal of the connection cable to the driver as shown in the figure.

However, the grounding resistance value provided in the standards that is applied to the equipment may not be satisfied depending on the type or length of the connection cable.

In this case, ground near the motor using the Protective Earth Terminal (⊕) on the motor. If the ground terminal of the connection cable is not used, be sure to insulate.

For the driver, ground near the driver using the Protective Earth Terminal (⊕).

Do not share the Protective Earth Terminal with a welder or any other power equipment.

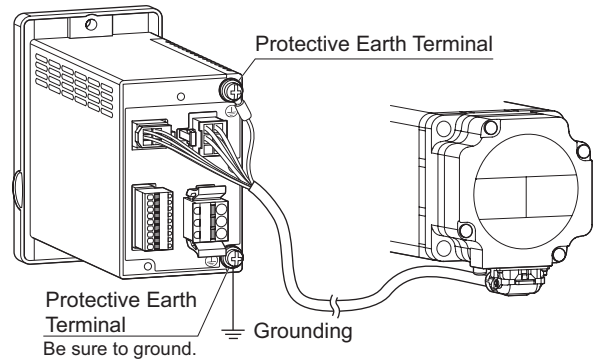

Reference

Protective earth wire of the connection cable

Conductor size: AWG18 (0.75 mm²)

Maximum conductor resistance: 25.0 Ω/km

■ Cable type

Be sure to ground using the Protective Earth Terminal (⊕) of the motor and the Protective Earth Terminal (⊕) of the driver.

Two Protective Earth Terminals (⊕) are provided on the driver. Ground either of the two Protective Earth Terminals near the driver. You can ground either of the two Protective Earth Terminals (⊕). The terminal that is not grounded is used as a service terminal. Use the service terminal according to your specific need, such as connecting it to the motor in order to ground the motor. Do not share the Protective Earth Terminal with a welder or any other power equipment.

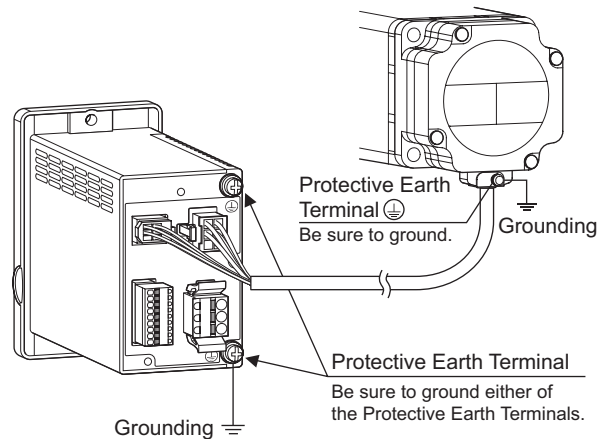

■ Connecting to Protective Earth Terminal

To connect to the Protective Earth Terminal, ground using the following grounding terminal. Ground as a short distance as possible.

Ground terminal

- Applicable crimp terminal: Round crimp terminal with insulation cover
- Thread size of terminal: M4
- Tightening torque: 1.2 N·m (10.6 lb-in)
- Applicable lead wire: AWG18 to 14 (0.75 to 2.0 mm²)

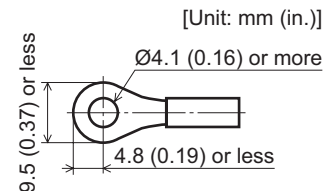

■ Precautions about static electricity

Static electricity may cause the driver to malfunction or suffer damaged.

Be sure to ground the motor and driver to prevent them from being damaged by static electricity.

5.3 Connecting the power supply

Connect the power cable to the CN1 on the driver.

The power cable is not included. It is provided as an accessory (sold separately). (p.38)

Note Check the specification of the power supply voltage for the driver before applying a voltage. If a voltage exceeding the rated range is applied, the driver may be damaged.

Input power supply	Connecting method
Single-phase 100-120 V	Connect the live side to terminal L, and the neutral side to terminal N.
Single-phase 200-240 V	
Three-phase 200-240 V	Connect the R, S and T phase lines to the L1, L2 and L3 terminals, respectively.

• Single-phase 100-120 V

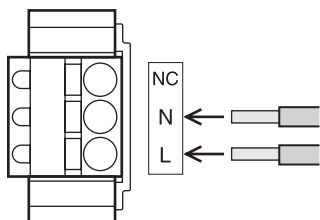

• Single-phase 200-240 V

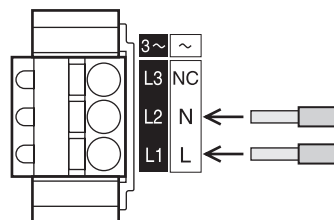

• Three-phase 200-240 V

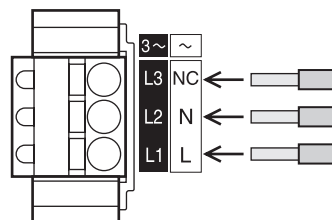

Connector model: FKC2,5/3-ST-5,08-RF (PHOENIX CONTACT GmbH & Co. KG)

The same driver can be used for single-phase 200-240 V and three-phase 200-240 V.

Connecting terminals vary depending on the power supply voltage used.

■ Connecting method

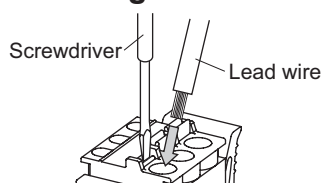

- Lead wire size: AWG18 to 14 (0.75 to 2.0 mm²)
- Length of the insulation cover which can be peeled: 10 mm (0.39 in.)

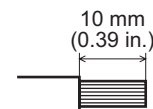

- Conductive material: Use only copper wire.

Crimp terminals can also be used to connect.

If crimp terminals are used, select the following terminals.

Manufacturer: PHOENIX CONTACT GmbH & Co. KG

- Model: AI 0,75-10 [Conductor cross-sectional area: 0.65 to 0.82 mm² (AWG18)]
 AI 1-10 [Conductor cross-sectional area: 0.82 to 1.2 mm² (AWG18)]
 AI 1,5-10 [Conductor cross-sectional area: 1.25 to 1.8 mm² (AWG16)]
 AI 2,5-10 [Conductor cross-sectional area: 2.0 to 3.0 mm² (AWG14)]

■ Circuit breaker

Be sure to connect a circuit breaker to the power line of the driver to protect the primary circuit.

Rated current of protective device: Single-phase input 10 A, three-phase input 5 A

Circuit breaker: Mitsubishi Electric Corporation NF30

5.4 Connecting the I/O signals

Connect the I/O signals to CN4 on the driver. Refer to p.16 for connection examples with a programmable controller.

Connecting the lead wire

- Applicable lead wire: AWG26 to 20 (0.14 to 0.5 mm²)
- Length of the insulation cover which can be peeled: 8 mm (0.31 in.)

Crimp terminals can also be used to connect. If crimp terminals are used, select the following terminals.

Manufacturer: PHOENIX CONTACT GmbH & Co. KG

Model: A 0,25-7 [Conductor cross-sectional area: 0.14 to 0.34 mm² (AWG24)]

A 0,34-7 [Conductor cross-sectional area: 0.14 to 0.34 mm² (AWG22)]

A 0,5-8 [Conductor cross-sectional area: 0.40 to 0.65 mm² (AWG20)]

Connector model: FK-MC0,5/9-ST-2,5 (PHOENIX CONTACT GmbH & Co. KG)

■ CN4 pin assignment

Pin No.	Terminal	Function *	Description
9	C0	IN-COM0	Input signal common (For external power supply)
8	X0	[FWD]	The motor rotates in the forward direction while this signal is being "ON."
7	X1	[REV]	The motor rotates in the reverse direction while this signal is being "ON."
6	X2	[M0]	This signal is used to select the operation data.
5	C1	IN-COM1	Input signal common (For internal power supply: 0 V)
4	Y0+	[SPEED-OUT]	30 pulses are output with each revolution of the motor output shaft.
3	Y0-		
2	Y1+	[ALARM-OUT1]	This signal turns OFF when an alarm generates (normally closed).
1	Y1-		

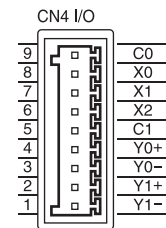

* The signal in brackets [] is a function that is assigned at the time of shipment. The assigned functions can be changed by setting parameters. Refer to p.27 for details.

■ Input signal circuit

All input signals of the driver are photocoupler inputs. Use these signals by the internal power supply (+5 VDC) or external power supply.

When using the external power supply, both sink input logic and source input logic can be used by changing the wiring. Usable external power supply: 24 VDC -15% to +20%, 100 mA or more

■ Output signal circuit

The driver outputs signals are photocoupler/open-collector output. The ON voltage of the output circuit is max. 1.5 V. When driving each element using the output signal circuit, give consideration to this ON voltage.

External power supply: 4.5 to 30 VDC, 100 mA or less (For the SPEED-OUT output, supply at least 5 mA of current.)

Note When connecting a relay (inductive load), etc., to detect alarm outputs, use a relay with built-in flywheel diode, or provide a fly-back voltage control measure based on diode, etc., for the inductive load.

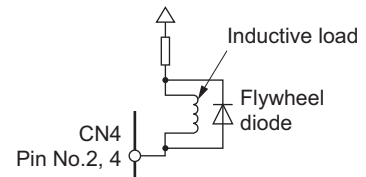

■ Using an external control equipment with a built-in clamp diode

If an external control equipment with a built-in clamp diode is used, a leakage path may form and cause the motor to operate even when the external control equipment power is off, as long as the driver power is on. Since the power capacity of the controller is different from that of the driver, the motor may operate when the external control equipment and driver powers are turned on or off simultaneously.

When powering down, turn off the driver power first, followed by the external control equipment power. When powering up, turn on the external control equipment power first, followed by the driver power.

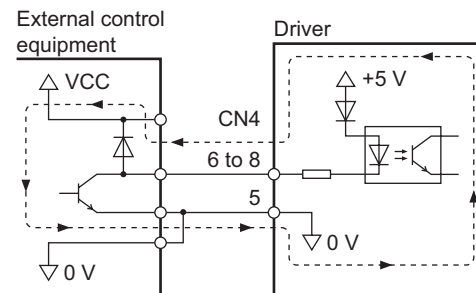

5.5 Connection diagram

■ Connection example for when using switches and relays

This is a connection example when the motor is operated using contact switches such as switches and relays. The connection example is of the single-phase input. The power supply connection for the three-phase input is different. (5.3 Connecting the power supply ⇒ p.13)

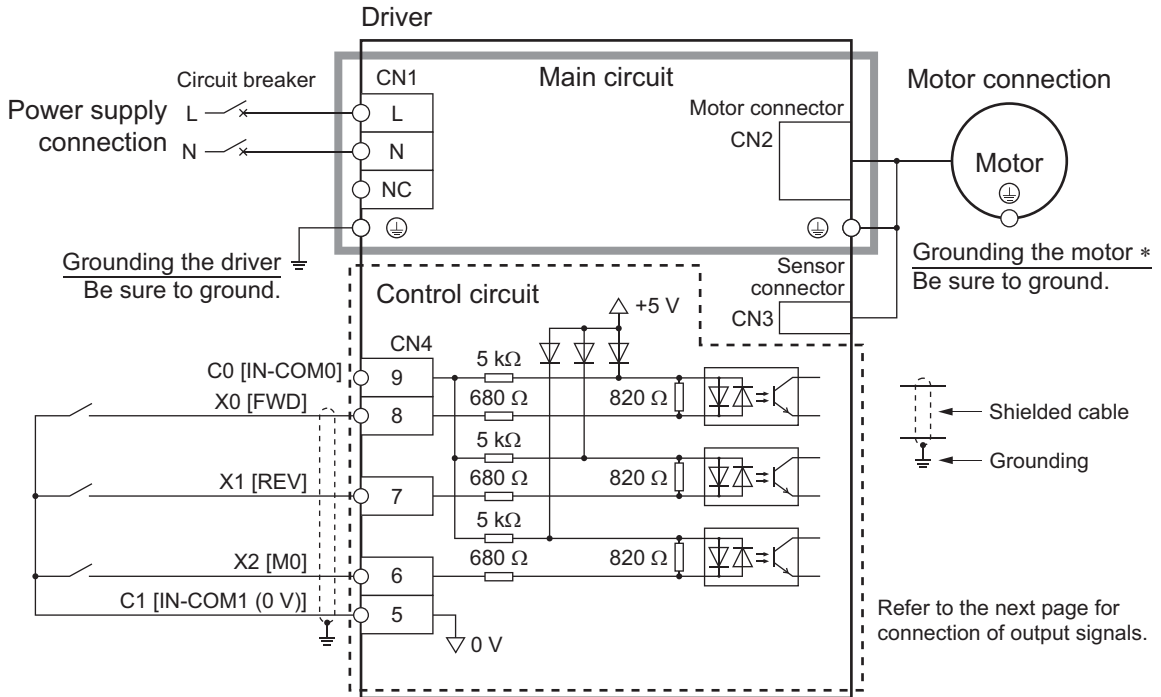

The I/O signal in the brackets [] is the assignment at the time of shipment.

* Be sure to ground. Refer to "5.2 Grounding" on p.12 for grounding.

■ Connection example for I/O signals and programmable controller

This is a connection example when the motor is operated using a transistor output type programmable controller.

Sink logic

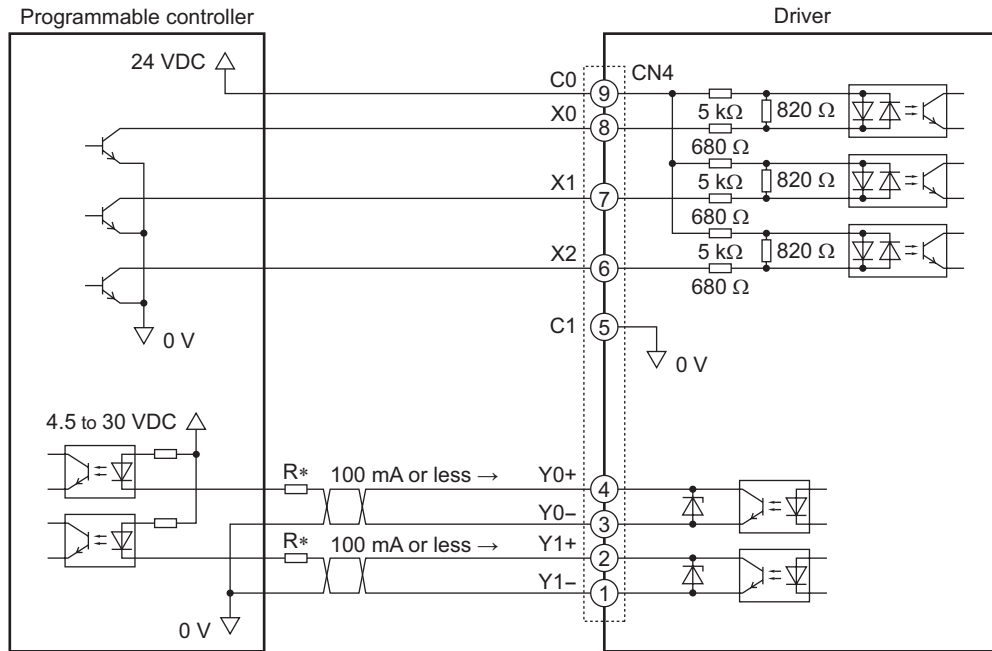

* Recommended resistance value for when the limiting resistor R is connected
 In the case of 24 VDC: 680 Ω to 2.7 kΩ (2 W)
 In the case of 5 VDC: 150 Ω to 560 Ω (0.5 W)

Source logic

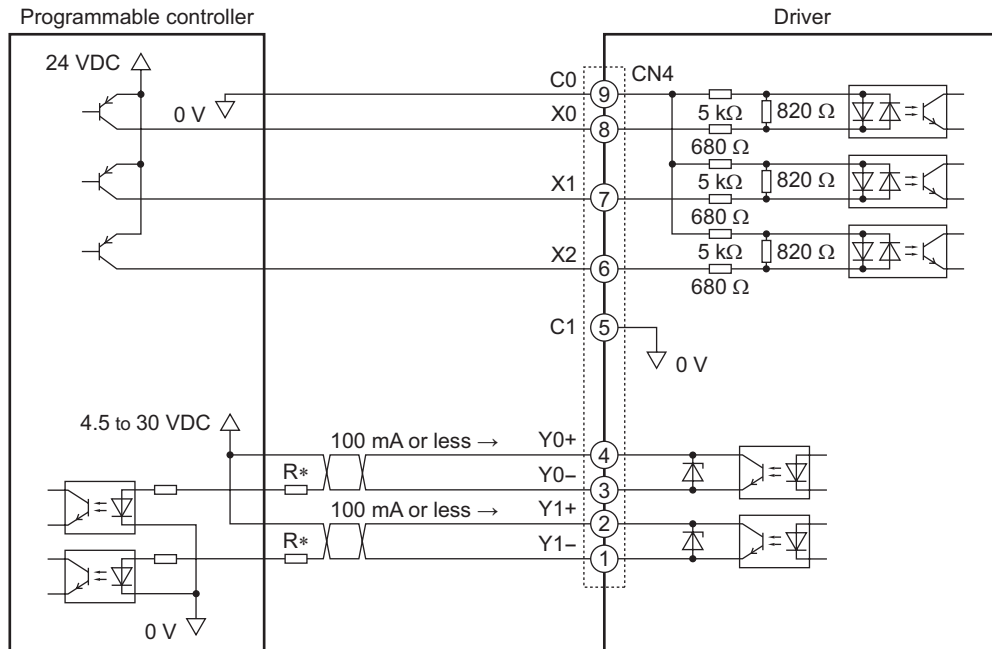

* Recommended resistance value for when the limiting resistor R is connected
 In the case of 24 VDC: 680 Ω to 2.7 kΩ (2 W)
 In the case of 5 VDC: 150 Ω to 560 Ω (0.5 W)

- Note**
- Use a power supply of 20.4 VDC to 28.8 VDC, 100 mA or more, for connecting input signals.
 - Turn on the external power supply before turning on the main power supply of the driver.
 - For the Y0 and Y1, be sure to keep the current value at 100 mA or less. If the current exceeds this value, connect the limiting resistor R.

6 Operating

6.1 Operation overview

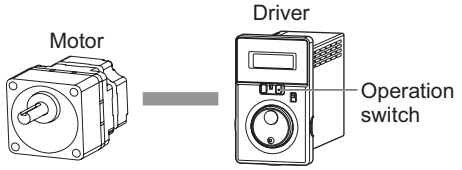
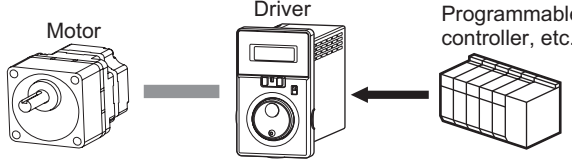
Operating by front panel	Operating by programmable controller
<p>The motor can be operated and stopped with the operation switch on the front panel.</p>  <p>● Connection: p.17 ● Operation: p.18</p>	<p>The motor can be operated and stopped using external signals.</p>  <p>● Connection: p.15, 16 ● Operation: p.19 ● Setting the parameter: p.24 ● Operating with multiple speeds: p.21</p> <p>Set the "operation switch" on the front panel to the RUN side even when operating with the external signals.</p>

6.2 Operating by front panel

This section explains how to operate the product with ease at the factory setting when receiving the product.

■ Connecting

The figure shows an example of the connector type. Refer to p.11 for the cable type.

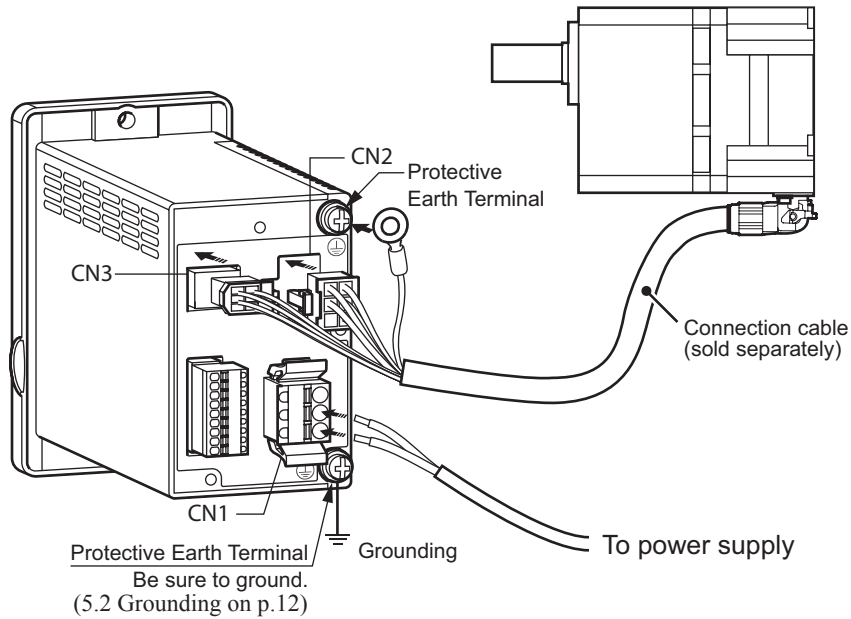

Connecting the power supply

Connect the AC power supply to the CN1 according to the input voltage.
Connecting the power supply: p.13

Example: Single-phase 100-120 V

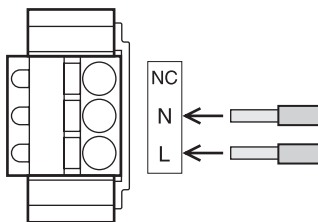

Connecting to the CN1

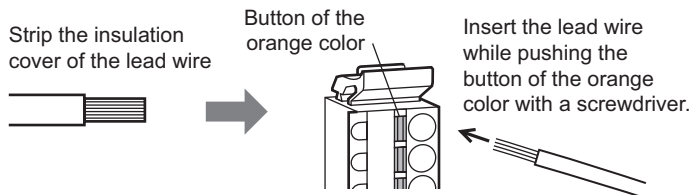

Note

- When cycling the power or plugging/unplugging the connector, turn off the power and wait for 1 minute or more before doing so.
- Ensure that the connector plugged in securely. Insecure connections may cause malfunction or damage to the product.

■ Inputting the power



Note When inputting the power, if the operation switch is set to the RUN side, the alarm code "AL 46" (prevention of operation at power-on) is displayed, and the operation cannot be executed.
Set the operation switch to the STAND-BY side and turn on the power.

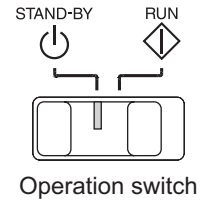

* Refer to p.33 for "prevention of operation at power-on" (alarm code: AL46).

■ Operating

After turning on the power, operate the product as follows.

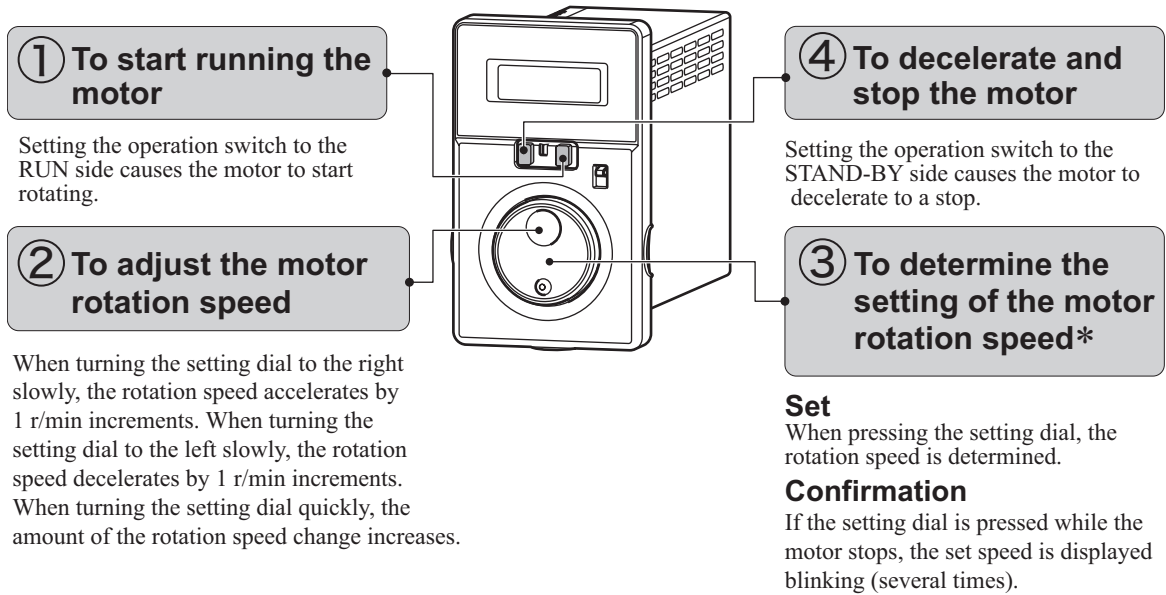

Setting the operation switch again to the RUN side causes the motor to start rotating at the set rotation speed.

*When the display is blinking, the rotation speed has not set yet. Determine it by pressing the setting dial.
(The set data is saved in the operation data No.0. Refer to p.24 for details.)

Operating with the setting dial can be limited by the lock function so that the set rotation speed cannot be changed. Refer to the p.31 "7.7 Data locking for the set data." for details.

Changing the rotation direction

Change the rotation direction of the motor and gearhead using the rotation direction switch. The rotation direction can be changed while operating.

In the case of the gearhead output shaft, the rotation direction varies depending on the gear ratio of the gearhead.

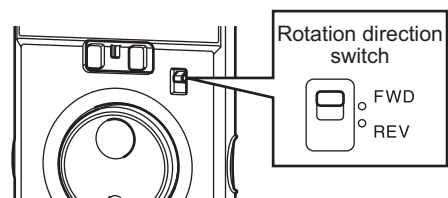

Check the operating manual supplied with the motor for the rotation direction of the gearhead output shaft.

For switching the display or setting, refer to p.23 "7 Convenient functions."

6.3 Operating by programmable controller

The motor can be operated and stopped externally.

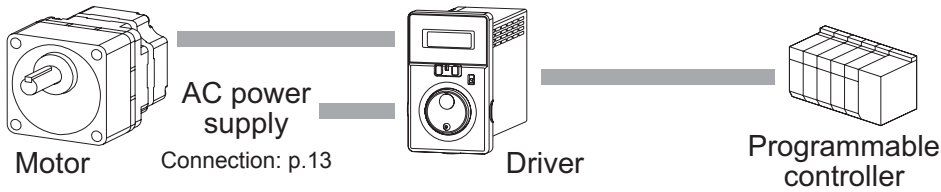

When the motor is operated and stopped externally, the "external operation signal input" parameter (IOEN) is required to change.

■ Operating

After connecting the operation input signals (FWD input, REV input) to the CN4, set and operate the product as follows.

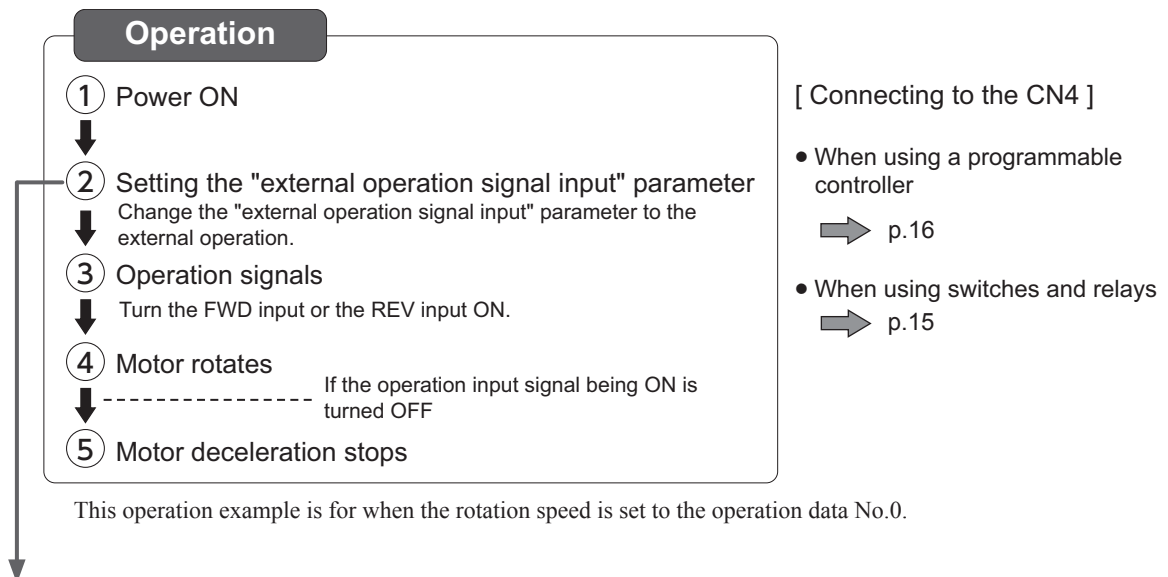

■ Setting the "external operation signal input" parameter

Change the setting for the "external operation signal input" parameter (IOEN) when operating and stopping the motor externally.

- "OFF" at the time of shipment: The operation using the front panel is set.
- Change to "ON" or "rE" for the setting of external operation.

Setting range

OFF : Operation/standstill using front panel (factory setting)

ON : Operation/standstill using external signals (The operation with the front panel is Enabled.)

rE : Operation/standstill using external signals (The operation with the front panel is Disabled.)

The "external operation signal input" parameter (IOEN) is found in the parameter mode. (p.24)

Front panel operation

Operation using the switches and setting dial on the front panel can be set to "Enable: O " or "Disable: x ."

Setting	Operation switch	Rotation direction switch	Setting dial
ON	O	O	O
rE	x	x	x *

* The data mode, parameter mode, and the I/O monitor of the monitor mode are enabled (possible to set).

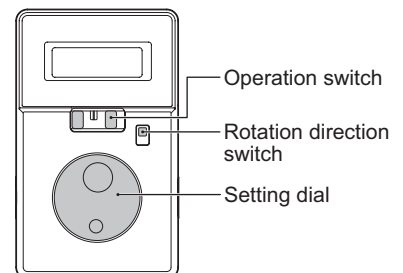

● When the setting is "ON"

Operation by switches on the front panel: Enable

When turning the operation input signal ON while the operation switch is set to the RUN side, the motor rotates.

When the operation switch is set to the "STAND-BY" side, the motor decelerates to a stop even if the operation input signal is being ON.

Turning the setting dial changes the motor rotation speed.

If the rotation direction switch is changed, the motor rotates in the opposite direction.

● When the setting is "RE"

Operation by switches on the front panel: Disable

If the operation switch or rotation direction switch are operated while setting to "RE," "rE" will be displayed.

Also, if the setting dial is operated while displaying the rotation speed, alarm, or warning in the monitor mode, "rE" will be displayed.

The data mode, parameter mode, and the I/O monitor of the monitor mode are enabled (possible to set).

The display time of "rE" varies depending on the switch.

- When setting the operation switch to the "RUN" side, "rE" will be displayed continuously.
- When switching the rotation direction switch to "FWD" (or "REV"), or when operating the setting dial, "rE" will be displayed for two seconds.

Operation • Stop

● Operation

The motor rotates when either of the FWD input or REV input is turned ON.

● Stop

There are two stopping methods.

Deceleration stop: If the signal being ON is turned OFF, the motor decelerates to a stop.

Instantaneous stop: If the FWD input and the REV input are turned ON simultaneously, the motor stops instantaneously.

Example of timing chart

This is an example for when the "external operation signal input" parameter is set to "ON" and the rotation direction switch is set to the "FWD" side.

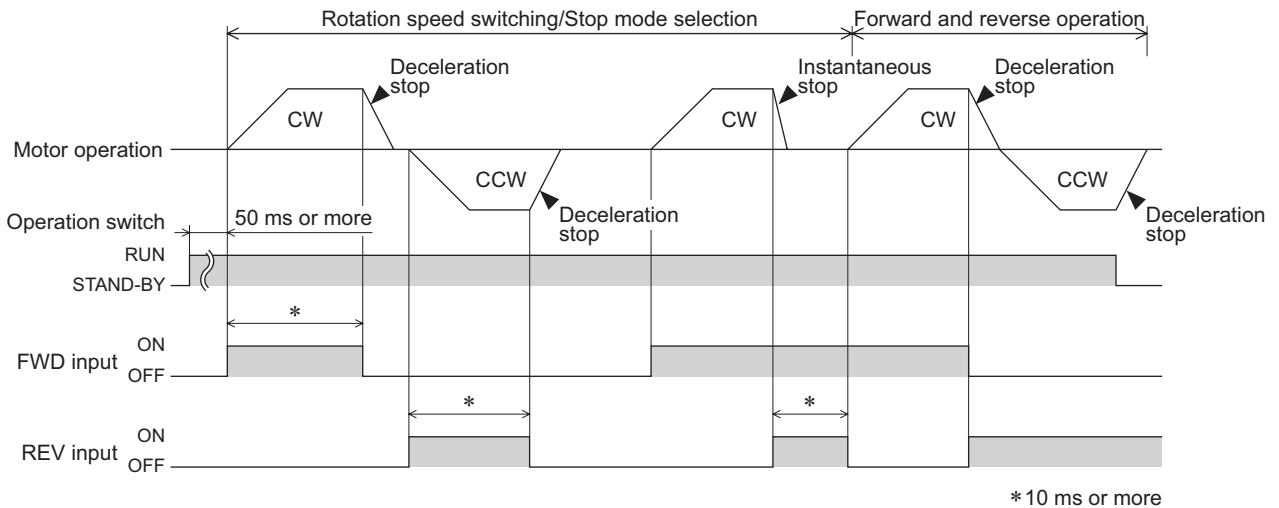

■ Operating with multiple speeds

Data of up to 4 speeds can be operated with switching the data by the external signal.
When 3 speeds or more are used, only unidirectional operation is available.

Data setting method

Example: Set the rotation speed to 3000 r/min (change from 50 r/min)

Power ON

Panel display
0

Press (M) two times

[Data mode]
DATA

Press (F)

[Data number selection screen]
d0

Data No.0: d0

Press (O)

[Data No.0 selection screen]
rEu0

Operating data No.0

The desired operation data can be selected by pressing (F).
· Rotation speed (rEu0)
· Acceleration time (tAd)
· Deceleration time (td0)
· Initialize (in d)

Setting the rotation speed

[Setting screen]

The display blinks

50

Rotation speed: 50 r/min (Factory setting)

Turn (O)

Turn (O) until the number reaches "3000"

[setting]

The display blinks

3000

Press (O)

[Data determined]

Blinks a few times fast

3000

rEu0

For the screen transitions, refer to p.24.

Select the other operation data number and set data.

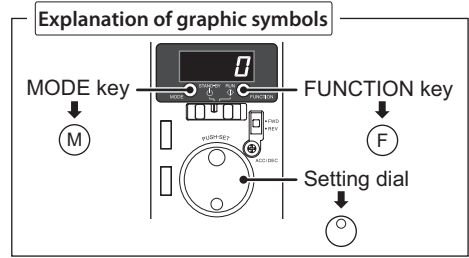

Operating method

Operate the motor by selecting any of the operation data No.0 to No.3 based on a combination of ON/OFF status of the M0 and M1 inputs. The motor is operated using the rotation speed, acceleration time, and deceleration time in the selected operation data number. This explains an example for when 4-speed operation is performed with the FWD, M0, and M1 inputs.

- [Operation procedure]
1. Set the "external operation signal input" parameter to "ON" from "OFF." (Factory setting: OFF)
 2. Set the operation switch to the "RUN" side.
 3. Select the operation data number using the M0 and M1 inputs.
 4. When the FWD input is turned ON, the motor rotates at the rotation speed of the selected operation data number.
 5. If the M0 and M1 inputs are switched, the motor changes to the rotation speed of the operation data number selected.
 6. If the FWD input being ON is turned OFF, the motor decelerates to a stop.

● Example of operating condition (4-speed operation *)

Operation data No.	M0	M1	Rotation speed [r/min]
0	OFF	OFF	3000
1	ON	OFF	1000
2	OFF	ON	2000
3	ON	ON	500

When changing from the present speed to the new speed, the acceleration time and deceleration time set in the next operation data number are used.

* In the case of the operation with 4 speeds, both the FWD input and the REV input cannot be assigned.

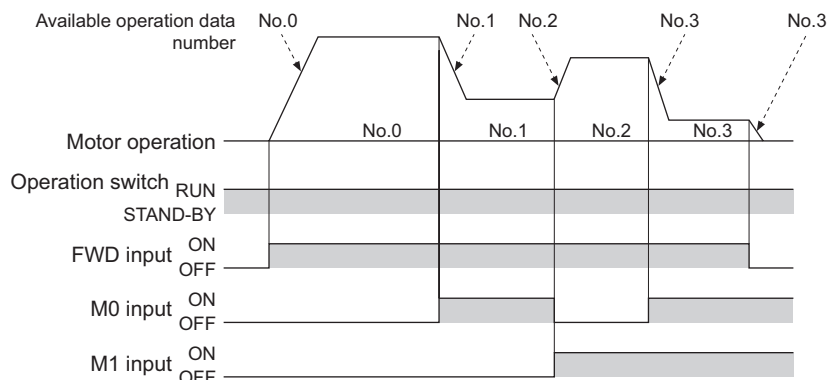

■ Switching the motor rotation direction

When turning the FWD input or REV input ON, the motor rotation direction varies depending on the state of the rotation direction switch. The rotation direction shown in the figure below is as viewed from the motor output shaft.

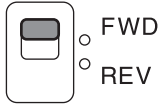
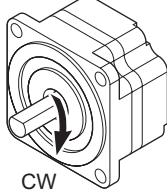
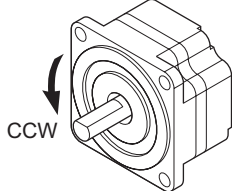
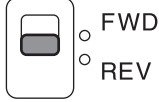
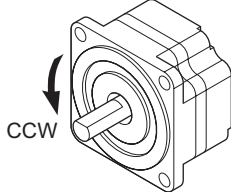
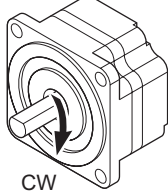
Rotation direction switch	External operation input	
	FWD input	REV input
<p>"FWD" side</p> 	<p>Motor rotation direction: <u>Clockwise</u></p> 	<p>Motor rotation direction: <u>Counterclockwise</u></p> 
<p>"REV" side</p> 	<p>Motor rotation direction: <u>Counterclockwise</u></p> 	<p>Motor rotation direction: <u>Clockwise</u></p> 

If the rotation direction switch is changed, the motor will decelerate to a stop and start rotating in the direction being switched.

If the "external operation signal input" parameter is set to "RE," the rotation direction switch will be disabled. The rotation direction at which "RE" was set is the same direction as the "FWD" side in the figure above.

Rotation direction of the gearhead output shaft

The rotation direction of the gearhead output shaft varies depending on the type or the gear ratio of the gearhead. Check the operating manual supplied with the motor for the rotation direction of the gearhead output shaft.

For switching the display or setting, refer to p.23 "7 Convenient functions."

7 Convenient functions

7.1 Functions list

The following functions are available for this product.

Functions	Description	Reference page	
D i s p l a y	Rotation speed	Displays the rotation speed of the motor output shaft.	28, 26
		Displays by converting the motor rotation speed into the rotation speed of the gearhead output shaft.	
	Conveyor transfer speed	Displays by converting the motor rotation speed into the transfer speed of the conveyor drive.	29, 26
	Speed increasing	Displays by converting the motor rotation speed into the increasing speed.	
	Load factor	Displays the load torque applied on the motor output shaft as a percentage (%).	28
	Operation data No.	Displays the operation data number that is presently operating.	
	Alarm	Displays the alarm information by the alarm code.	28, 32
		Displays the alarm records.	
	Warning	Displays the warning information by the warning code.	28, 35
		Displays the warning records.	
I/O signals	Checks whether a signal is input.	28	
	Checks whether a signal is output.		
S e t t i n g	Rotation speed	Sets the motor rotation speed using the setting dial.	18
		Sets the motor rotation speed in the operation data.	29
	Acceleration time, deceleration time	Sets using the acceleration/deceleration time potentiometer.	30
		Sets in the operation data.	29
	Lock function	Disables an operation with the setting dial so that the set data cannot be changed.	31
	Operation using programmable controller	Operates by inputting signals externally.	19
		Disables an operation with the setting dial on the front panel.	
		Operates with multiple speeds. (Up to 4 speeds)	21
	Limiting the setting range of the rotation speed	Sets the upper limit and lower limit of the rotation speed.	31
	Slight position-keeping	The load position can be kept at motor standstill.	32
	Changing the function for I/O signals	Changes the functions assigned to the input signals (3 input signals).	27
		Changes the functions assigned to the output signals (2 output signals).	
	Initial display at power ON	Changes the display item when turning on the power.	26
Data initialization	Restores the operation data to the factory setting (initial value).	29	
	Restores the parameter setting to the factory setting (initial value).	26	

7.2 Setting items and panel displays

The display is lit **50**

This is a state being set.
After the setting was changed, it is determined when the display changes from blinking to lighting.

The display blinks **50**

The setting can be changed while the display blinks.

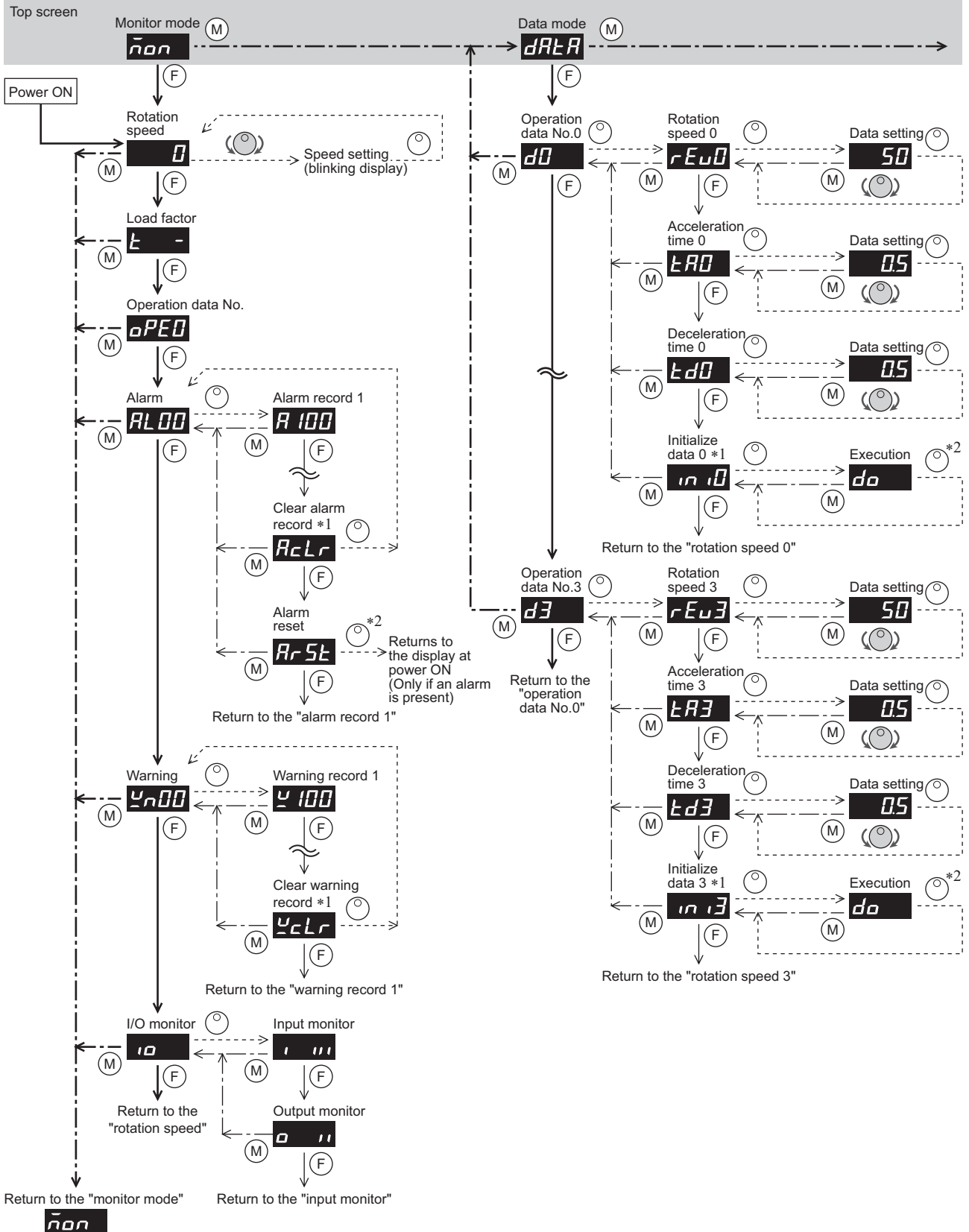

The display for when turning on the power can be changed using the "panel initial view" parameter.

Explanation of graphic symbols

When the front panel is removed

(M) : Press the MODE key

(F) : Press the FUNCTION key

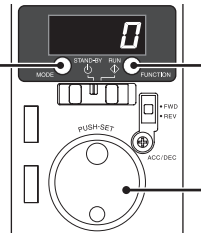

Setting dial

(Turn icon) : Turn the setting dial
(Press icon) : Press the setting dial

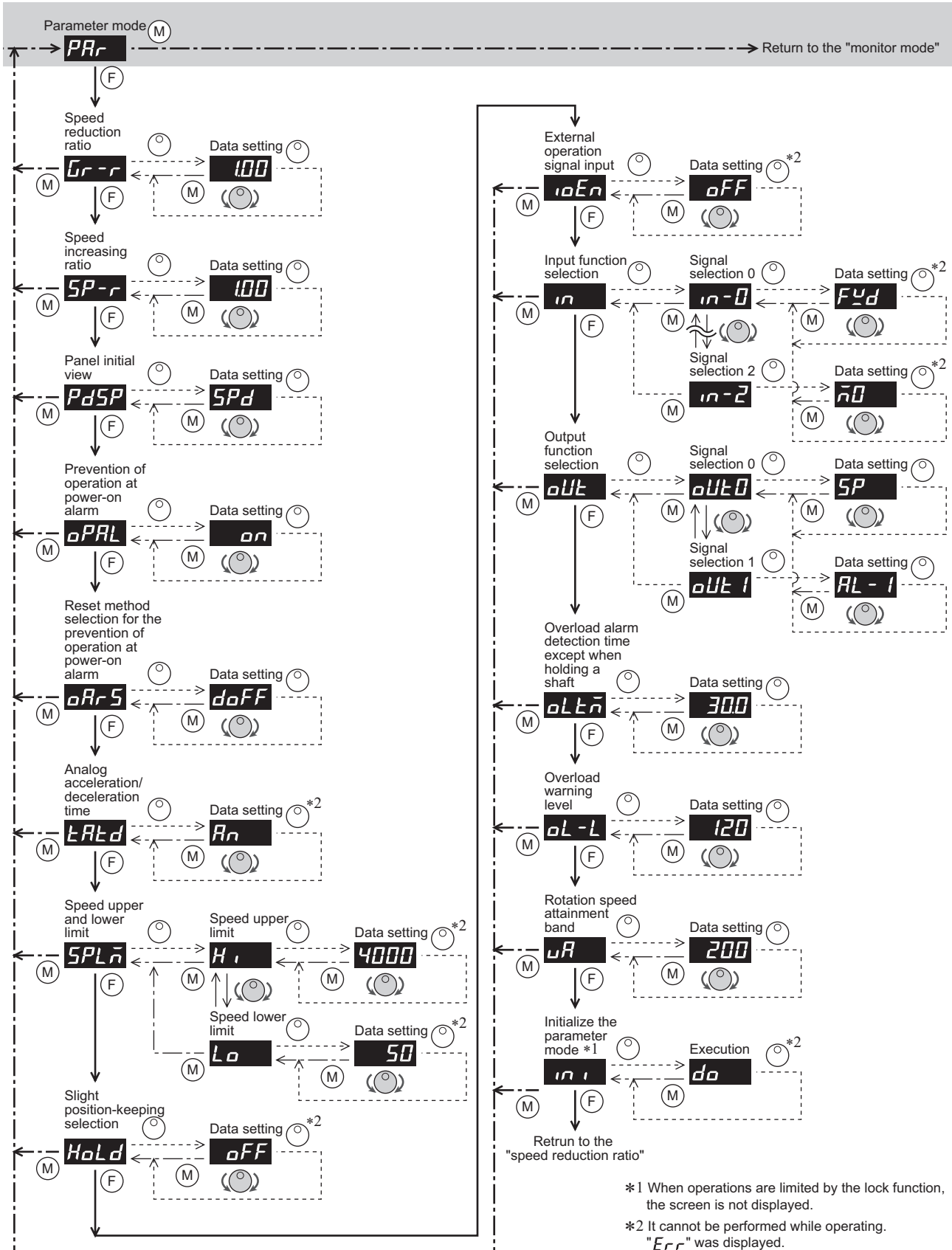

*1 When operations are limited by the lock function, the screen is not displayed.

*2 It cannot be performed while operating. "Err" was displayed.

7.3 Parameter list

Operation mode: Parameter mode

Item	Display	Description	Setting range	Factory setting
Speed reduction ratio	<i>Cr-r</i>	Sets the speed reduction ratio relative to the rotation speed of the motor output shaft. Displays the speed calculated based on the speed reduction ratio on the monitor mode. If the speed reduction ratio for the conveyor is calculated and input, the conveyor transfer speed can also be displayed.	1.00 to 9999	1.00
Speed increasing ratio	<i>SP-r</i>	When increasing the motor rotation speed using the external mechanism and others, the converted speed can be displayed.	1.00 to 2.00	1.00
Panel initial view	<i>PdSP</i>	After the power is turned on, the item displayed on the monitor mode can be changed.	<i>SPd</i> Rotation speed (r/min) <i>Er%</i> Load factor (%) <i>d-no</i> Operation data No.	<i>SPd</i>
Prevention of operation at power-on alarm	<i>oPRL</i>	Sets whether to enable or disable the "prevention of operation at power-on alarm." Refer to p.32 for alarms.	<i>oFF</i> Disable <i>on</i> Enable	<i>on</i>
Reset method selection for the prevention of operation at power-on alarm	<i>oArS</i>	Selects how to reset the prevention of operation at power-on alarm.	<i>doFF</i> Resets by turning the FWD or REV input OFF or by setting the operation switch to the STAND-BY side. <i>ArSt</i> Resets using the ALARM-RESET input or the alarm reset on the monitor mode.	<i>doFF</i>
Analog acceleration/ deceleration time	<i>tARtd</i>	Changes the setting method of acceleration/deceleration time.	<i>Rn</i> Using the acceleration/ deceleration time potentiometer (analog) <i>dIG</i> Sets using the operation data(digital)	<i>Rn</i>
Speed upper and lower limit	Speed upper limit	<i>Hl</i>	Sets the upper limit of the rotation speed.	4000
	Speed lower limit	<i>Lo</i>	Sets the lower limit of the rotation speed.	
Speed upper and lower limit	<i>SPLn</i>		0, 50 to 4000	
Slight position-keeping selection	<i>HoLd</i>	The load position can be kept at motor standstill.	<i>oFF</i> Disable <i>on</i> Enable	<i>oFF</i>
External operation signal input	<i>oErn</i>	The operation method can be selected between the front panel and external input signals. When operating or stopping the motor using the external input signals, the functions of the operation switch, rotation direction switch, and setting dial can be set to disable.	<i>oFF</i> Operation/standstill using front panel <i>on</i> Operation/standstill using external signals (Front panel operation: Enable) <i>rE</i> Operation/standstill using external signals (Front panel operation: Disable)	<i>oFF</i>
X0 input function selection	<i>in-0</i>	Assigns the input signals to the external input terminals.	<i>----</i> Not used <i>FYd</i> FWD <i>rEu</i> REV	<i>FYd</i>
X1 input function selection	<i>in-1</i>		<i>n0</i> M0 <i>n1</i> M1	<i>rEu</i>
X2 input function selection	<i>in-2</i>		<i>ArSt</i> ALARM-RESET <i>E-Er</i> EXT-ERROR <i>H-Fr</i> H-FREE	<i>n0</i>

Item	Display	Description	Setting range	Factory setting
Y0 output function selection		Assigns the output signals to the external output terminals.	---- Not used RL-1 ALARM-OUT1	SP
Y1 output function selection			SP SPEED-OUT RL-2 ALARM-OUT2 MOVE VA WNG	
Overload alarm detection time except when holding a shaft		Sets the time to output the alarm after detecting the overload condition when a load up to the limited duty region exceeding the continuous duty region was applied.	0.1 to 60.0 s	30.0
Overload warning level		Sets the detection level (load factor) for the overload warning function based on the rated current being 100%.	50 to 120%	120
Rotation speed attainment band		Sets the band within which the rotation speed of the motor is deemed to have reached the set value.	0 to 400 r/min	200
Initialize the parameter mode		Restores the value set in the parameter mode to the factory setting.	-	-

- Note**
- Do not turn off the motor power while the initialization is still in progress (= while the display is blinking). Doing so may damage the data.
 - When setting the speed increasing ratio to 1.00, the speed reduction ratio will be effective. When setting the speed increasing ratio to other than 1.00, the speed increasing ratio will be effective.
 - When setting a longer time in the "overload alarm detection time except when holding a shaft" parameter, an overload status may continue. Repeating this condition may result in shorter service life of the motor and gearhead.
 - If a load exceeding the limited duty region was applied or the output shaft was locked, the "overload alarm detection time except when holding a shaft" is maximum 5 seconds.

Description of I/O signals

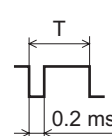
Signal	Terminal	Signal name	Description
Input	X0 X1 X2	FWD	The motor rotates when either of the FWD input or REV input is turned ON. If the FWD input and REV input are turned ON simultaneously, the motor stops instantaneously.
		REV	
		M0	These signals are used to select the operation data number.
		M1	If both signals are turned OFF, the operation data No.0 is selected.
		ALARM-RESET	This signal is used to reset the present alarm when a protective function was activated. Refer to p.34 for timing chart.
		EXT-ERROR	When turning this signal OFF, an alarm generates and the motor stops instantaneously. Then "ALERR" will be shown on the display (normally closed).
		H-FREE	The slight position-keeping is released when the H-FREE input is turned ON. (When the slight position-keeping selection is set to "Enable")
Output	Y0 Y1	ALARM-OUT1	This signal is output when an alarm generates (normally closed).
		SPEED-OUT	30 pulses are output with each revolution of the motor output shaft synchronously with the motor operation. The pulse width of output pulse signals is 0.2 ms. You can use the SPEED-OUT output to calculate the motor speed. $\text{SPEED-OUT output frequency (Hz)} = \frac{1}{T}$ $\text{Rotation speed (r/min)} = \frac{\text{SPEED-OUT output frequency}}{30} \times 60$ 
		ALARM-OUT2	This signal is output when exceeding the overload warning level. Or this signal is output when an overload alarm generates (normally closed).
		MOVE	This signal is output while the motor is operating.
		VA	This signal is output when the motor rotation speed becomes equal the value set by the rotation speed attainment band parameter.
		WNG	This signal is output when a warning generates. (The motor will continue to operate.) When the warning is released, it will automatically turn OFF.

- Note** Do not assign the same input signal to multiple input terminals. When the same input signal is assigned to multiple input terminals, the function will be executed if any of the terminals becomes active.

7.4 Items displayed on the driver

Operation mode: Monitor mode

Item	Display	Description
Rotation speed *		<ul style="list-style-type: none"> Monitors the rotation speed of the motor. Monitors the rotation speed of the gear output shaft or conveyor transfer speed when the "speed reduction ratio" parameter is set. When the "speed increasing ratio" parameter is set, the rotation speed being increased by the external mechanism is displayed.
Load factor		<p>The motor generating torque can be checked. The present load factor is displayed based on the rated torque being 100%. The load factor is displayed in 1% increment between 40% and 200%, and "L -" is displayed if the load factor is smaller than 40%.</p> <p>The display is the load factor on the motor output shaft. It is not for the gearhead output shaft.</p> <p>In the case of the gearhead output shaft, the permissible torque varies depending on the gear ratio of the gearhead used.</p> <p>Use the product so that the load does not exceed the permissible torque of the gearhead output shaft.</p> <p>When the slight position-keeping is enabled, "L H" is displayed.</p>
Operation data No.		Monitors the operation data No. currently selected.
Alarm		When an alarm generates, the alarm code is displayed. You can also reset alarms or check and clear alarm records. Refer to p.32 for alarm type.
Warning		When a warning generates, the warning code is displayed. You can also check and clear warning records. Refer to p.35 for warning type.
I/O monitor		<p>You can check the ON/OFF status of each I/O signal of the driver. If the signal is ON, the corresponding digit is lit. If the signal is OFF, the digit is unlit.</p> <div style="display: flex; justify-content: space-around; align-items: center;"> <div style="text-align: center;"> <p>Input signals</p> </div> <div style="text-align: center;"> <p>Output signals</p> </div> </div>

* For the factory setting, the rotation speed is displayed when the power is turned on. The display for when turning on the power can be changed using the parameter. Panel initial view parameter: p.26

■ Display of the rotation speed

In the case of motors with the **JH** gearhead, use the actual gear ratio about the gear ratio of gearhead. Check the operating manual supplied with the motor for the actual gear ratio.

● Displayed digit number when setting the speed reduction ratio or speed increasing ratio

Since the number of significant figures for the integer part is changed if the speed reduction ratio or speed increasing ratio is set, the digit number displayed on the panel will also be changed.

Setting value for the speed reduction ratio and speed increasing ratio	Display digit on the monitor mode
1.00 to 9.99	0 to 9999
10.00 to 99.99	0.0 to 999.9
100.0 to 999.9	0.00 to 99.99
1000 or more	0.000 to 9.999

● Display the conveyor transfer speed

To display the conveyor transfer speed, calculate the conveyor speed reduction ratio by using the formula below and set to the "speed reduction ratio" parameter.

$$\text{Conveyor speed reduction ratio} = \frac{1}{\text{Feed rate per motor revolution}} = \frac{\text{Gearhead gear ratio}}{\text{Pulley diameter [m]} \times \pi}$$

When the calculated conveyor speed reduction ratio is used, the conveyor transfer speed is converted as follows:

$$\text{Conveyor transfer speed [m/min]} = \frac{\text{Motor output shaft rotation speed [r/min]}}{\text{Conveyor speed reduction ratio}}$$

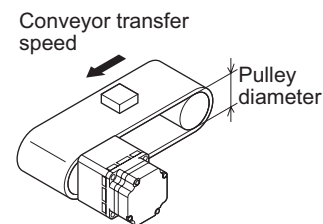

Example: The pulley diameter is 0.1 m and gear ratio of the gear head is 20

$$\text{Conveyor speed reduction ratio} = \frac{\text{Gearhead gear ratio}}{\text{Pulley diameter [m]} \times \pi} = \frac{20}{0.1 \text{ [m]} \times \pi} \cong 63.7$$

From the conversion formula, the conveyor speed reduction ratio is calculated as 63.7 in this example. If the speed reduction ratio is 63.7 and rotation speed of the motor is 1300 r/min, the conveyor transfer speed is converted as follows:

$$\text{Conveyor transfer speed [m/min]} = \frac{1300}{63.7} \cong 20.4$$

Accordingly, "20.4" is shown on the panel.

■ Display while an alarm generates

The alarm code is displayed while the alarm generates, and the screen can be changed to other screens by pressing the MODE key or FUNCTION key.

However, even if the screen moved from the alarm code screen to others, the alarm code display blinks so that the alarm state can be checked.

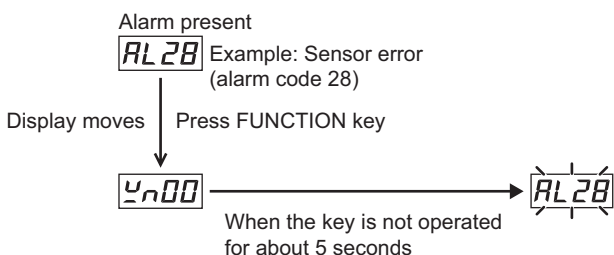

7.5 Setting the operation data

Four types of operation data can be set in this product. Operate by selecting the operation data number using the M0 and M1 input signals. Refer to p.21 for details.

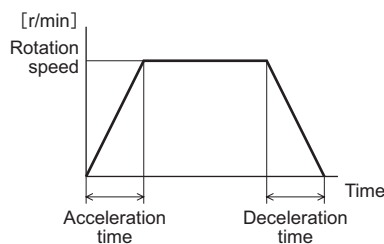

Operation mode: Data mode

Item	Display	Setting range	Factory setting	
Operation data No.0 No.1 No.2 No.3	Rotation speed	rEu	0, 50 to 4000 r/min	50
	Acceleration time	tA	0.0 to 15.0 sec	0.5
	Deceleration time	tD		
	Initialization	in i	Restores the operation data to the factory setting. Initializes each operation data number.	

Refer to the next page for details about the acceleration time and deceleration time.

7.6 Setting the acceleration time and deceleration time

The acceleration time and deceleration time can be set so that an impact is not applied to a load when the motor is started or stopped. There are the following two methods to set. The setting by the "acceleration/deceleration time potentiometer" is enabled at the time of shipment.

■ Setting using the acceleration/deceleration time potentiometer (factory setting)

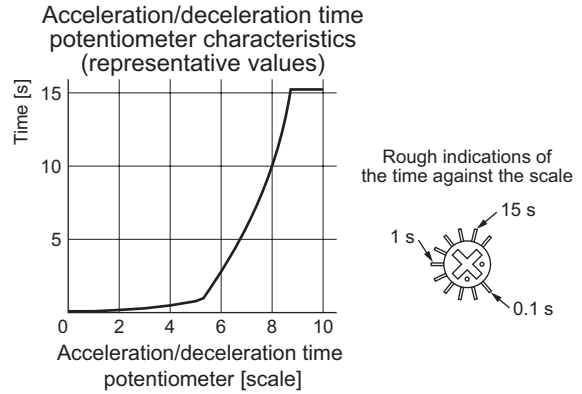
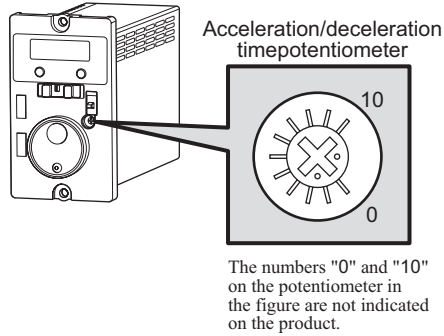

Setting range: 0.1 to 15.0 sec (factory setting: 0.1 sec)

● Acceleration time

The acceleration time is set as the time needed for the motor to reach the rated rotation speed (3000 r/min) from the standstill state.

● Deceleration time

The deceleration time is set as the time needed for the motor to stop from the rated rotation speed (3000 r/min).

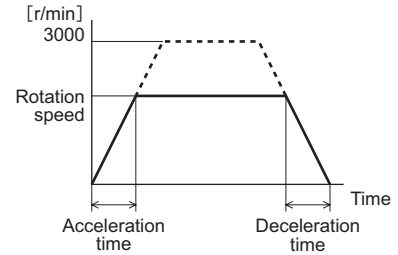

■ Setting to the operation data with digital setting

When setting by the acceleration time and deceleration time of the data mode, set the "analog acceleration/deceleration time" parameter of the parameter mode to the digital setting. For the acceleration time and deceleration time in this digital setting, set the time needed to reach the set rotation speed.

Setting range: 0.1 to 15.0 sec (factory setting: 0.5 sec)

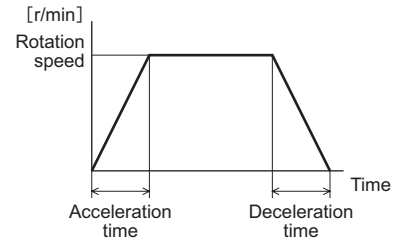

■ Motor operation

If the acceleration time and deceleration time are set shorter than 0.5 seconds, the motor takes for a longer time than 0.5 seconds to reach the speed.

If they are set to approximately 0.5 seconds or more, the motor can accelerate and decelerate in the setting time. (With no load)

When the frictional load or load inertia is increased, the operating time to reach the setting will be longer.

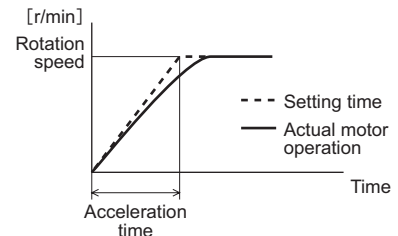

7.7 Data locking for the set data

The data setting can be locked so that the set rotation speed does not change.
The setting of data and parameters cannot be changed using the setting dial while locking.

Remove the front panel and perform the operations shown in the next.

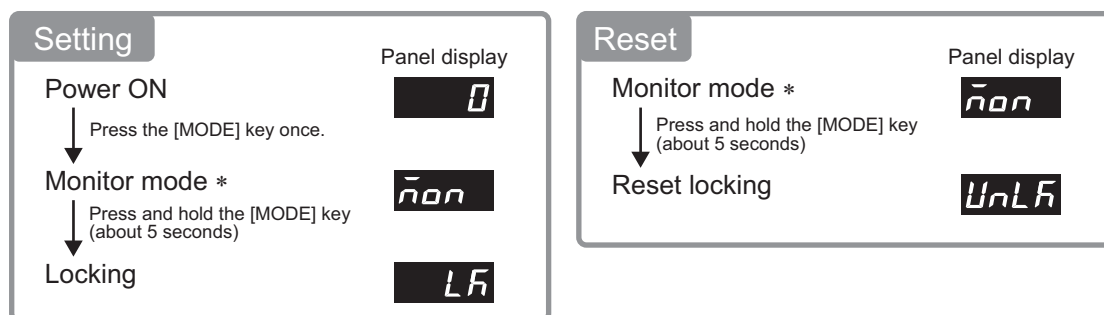
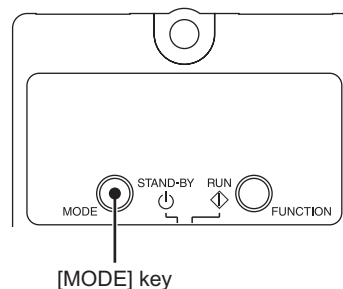

* Even when the top screen (*dALr, PAr*) of the data mode or parameter mode is displayed, the data locking or reset locking can be performed.

- Display for when the edit lock function is enabled

If the setting value of the operation data or parameter is tried to change, "Lr" is displayed for about one second.

7.8 Limiting the setting range of the rotation speed

The setting range of the rotation speed is set to 50 to 4000 r/min at the time of shipment. This setting range can be changed to limit.

Setting range of the rotation speed

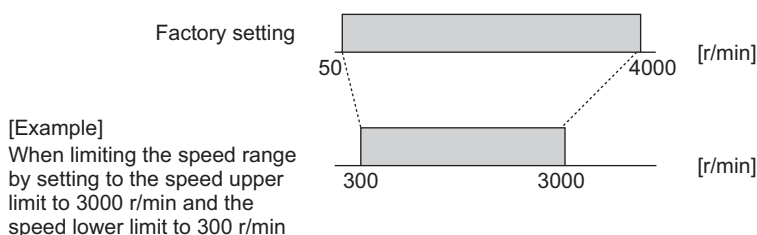

- Speed upper limit

Set the upper limit value of the rotation speed in the "speed upper limit" of the "speed upper and lower limit" parameter.

The rotation speed exceeding the "speed upper limit" cannot be set in the rotation speed of the operation data.

If the rotation speed exceeding the "speed upper limit" is already set in the operation data, the rotation speed set in the "speed upper limit" will be overwritten.

- Speed lower limit

Set the lower limit value of the rotation speed in the "speed lower limit" of the "speed upper and lower limit" parameter.

The rotation speed lower than the "speed lower limit" cannot be set in the rotation speed of the operation data.

If the rotation speed lower than the "speed lower limit" is already set in the operation data, the rotation speed set in the "speed lower limit" will be overwritten.

7.9 Holding a load at motor standstill

If the "slight position-keeping selection" parameter is set to ON (enable), the holding torque is somewhat generated when the motor stops (slight position-keeping torque).

The factory setting is OFF (disable). Refer to p.24 or p.26 for how to change the parameter.

● Slight position-keeping torque

Approximately 50% of the rated torque is generated according to the angular variation of the motor output shaft (figure below).

Note

- Do not continuously apply a load exceeding the slight position-keeping torque. Continuing to rotate the motor output shaft by the external force may cause damage to the motor.
- Do not use for the purpose of anti-drop mechanism in the event of a power outage. If the power supply to the driver is turned off, the holding force of the motor may lose, causing the load to fall.

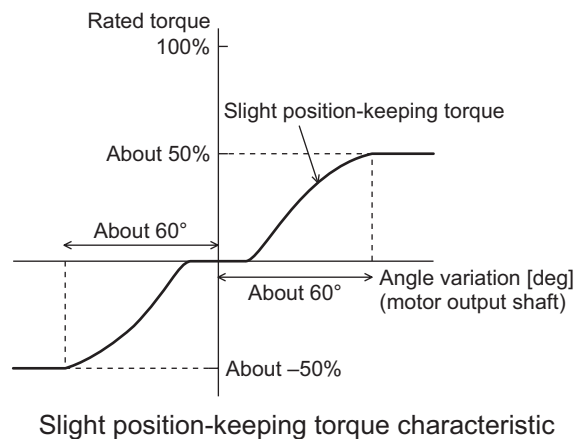

8 Alarms and warnings

The driver provides alarms that are designed to protect the driver from overheating, poor connection, error in operation, etc. (protective functions), as well as warnings that are output before the corresponding alarms generate (warning functions).

8.1 Alarms

If a protective function is activated and an alarm is generated, the motor will coast to a stop, and then the holding power of the motor output shaft is lost. At the same time, the alarm code is displayed. The alarm type can be checked by the alarm code.

Note

- Cycle the power to reset the overcurrent and EEPROM error alarms. When cycling the power, turn off the power and wait for minimum 1 minute before doing so. If the product does not operate properly after the power is cycled, the internal circuit may be damaged. Contact your nearest Oriental Motor branch or sales office.
- The motor stops instantaneously at the time of external stop (*RLSE*). After the motor is stopped, the holding power of the motor output shaft is lost.

■ Alarm list

Alarm code	Alarm type	Cause	Remedial action	Alarm reset *1
<i>AL20</i>	Overcurrent	Excessive current has flown through the driver due to ground fault, etc.	Check the wiring between the driver and motor for damage.	Not possible
<i>AL21</i>	Main circuit overheat	The temperature inside the driver exceeded the alarm detection temperature.	<ul style="list-style-type: none"> Review the ambient temperature. Review the ventilation condition in the enclosure. 	Possible
<i>AL22</i>	Overvoltage	<ul style="list-style-type: none"> The power supply voltage exceeded approximately 120% of the rated voltage. Vertical drive (gravitational operation) was performed or a load exceeding the permissible load inertia was driven. 	<ul style="list-style-type: none"> Check the power supply voltage. If this alarm occurs during operation, reduce the load or make the acceleration/deceleration time longer. 	
<i>AL25</i>	Undervoltage	The power supply voltage became lower than approximately 60% of the rated voltage.	<ul style="list-style-type: none"> Check the power supply voltage. Check the wiring of the power supply cable. 	
<i>AL28</i>	Sensor error	During operation, the sensor signal line of the motor cable or connection cable was disconnected, or the sensor connector came off.	Check the wiring between the driver and motor.	Possible
<i>AL30</i>	Overload	<ul style="list-style-type: none"> A load exceeding the continuous duty region was applied to the motor for the time exceeded the value set in the "overload alarm detection time except when holding a shaft" parameter. Or the output shaft was locked.*2 The motor was started running under the state that the motor temperature was low. 	<ul style="list-style-type: none"> Reduce the load. Review the operation pattern such as acceleration/deceleration time. If the ambient temperature is low, perform a trial operation in a light load state. 	
<i>AL31</i>	Overspeed	The rotation speed of the motor output shaft exceeded approximately 4800 r/min.	<ul style="list-style-type: none"> Reduce the load. Review the operation pattern such as acceleration/deceleration time. 	
<i>AL41</i>	EEPROM error	<ul style="list-style-type: none"> The stored data was damaged. Data became no longer writable or readable. 	Initialize the parameters.	Not possible
<i>AL42</i>	Sensor error at power-on	Before the power supply is turned on, the sensor signal line of the motor cable or connection cable was disconnected, or the sensor connector came off.	Check the wiring between the driver and motor.	Possible
<i>AL45</i>	Prevention of operation at power-on *3	When the "external operation signal input" parameter was set to "OFF," while the operation switch was set to the "RUN" side, the power was turned on again.	Set the operation switch to the "STAND-BY" side from the "RUN" side.	
		When the "external operation signal input" parameter was set to "ON," while the FWD input or REV input was turned ON, the power was turned on again.	<ul style="list-style-type: none"> Set the operation switch to the "STAND-BY" side from the "RUN" side. Turn the FWD input or REV input from ON to OFF. 	
<i>AL5E</i>	External stop *4	The EXT-ERROR input turned OFF.	Check the EXT-ERROR input.	

*1 When using the alarm reset on the monitor mode or resetting the alarm by assigning the ALARM-RESET input to the input terminal.

*2 If a load exceeding the limited duty region was applied or the output shaft was locked, an alarm is generated in maximum 5 seconds. However, if the value of the "overload alarm detection time except when holding a shaft" parameter is set to 5 seconds or less, the overload alarm is generated in the time that was set.

*3 This alarm is output when the "prevention of operation at power-on alarm" parameter is set to "Enable." Refer to p.26 for setting whether to enable or disable the "prevention of operation at power-on alarm" parameter.

*4 This alarm is output when the EXT-ERROR is assigned to input terminal.

■ Alarm reset

Always reset an alarm after ensuring safety by removing the cause of the alarm and turning the operation signal OFF.

[How to reset the alarm]

- Turn the ALARM-RESET input to ON and then OFF. (The alarm will be reset at the OFF edge of the input.)
- Perform an alarm reset with the monitor mode.
- Turn off the power, wait for at least 1 minute, and then cycle the power.

When an alarm is reset, "AL00" is displayed for two seconds, then "0" * is displayed. (Except for cycling the power)

* The screen selected in the "panel initial view" parameter is displayed.

- Note**
- If the motor does not operate properly after the power is cycled, internal circuit damage is suspected. Please contact your nearest Oriental Motor branch or sales office.
 - Continuing the operation without removing the cause of the problem may cause malfunction of the equipment.

● Reset using the ALARM-RESET input

Turn the operation signal OFF and then turn ALARM-RESET input ON (keep it ON for 10 msec or more).

The ALARM-RESET input is disabled while the operation signal is being ON.

The figure shows an example for which the operation signal is the FWD input.

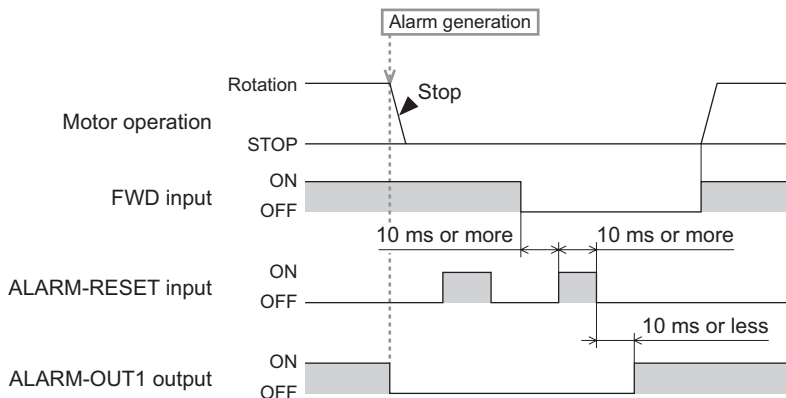

● Reset with the monitor mode

Set the operation switch to the "STAND-BY" side from the "RUN" side, and reset the alarm by the following steps.

Alarm present

AL28 Example: Sensor error
(alarm code 28)

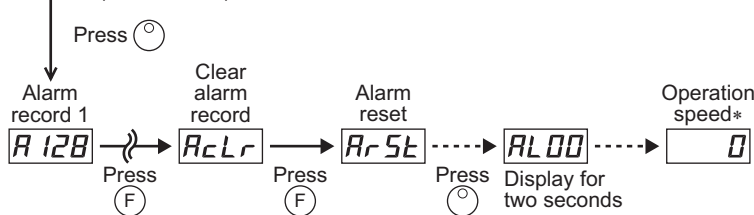

* The screen selected in the "panel initial view" parameter is displayed.

Explanation of graphic symbols

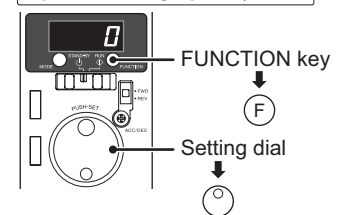

● When the present alarm is the prevention of operation at power-on alarm "AL45"

When operating the motor using the front panel, change the setting of the operation switch from the RUN side to the STAND-BY side.

When operating the motor using external input signals, the alarm will be reset by turning the operation signal OFF.

This is the factory setting. The method to reset the alarm can be changed. Refer to p.24 or p.26 for details.

■ Alarm records

Up to 9 generated alarms are saved in the non-volatile memory in order of the latest to oldest.

When clearing the alarm records, perform the alarm record clear on the monitor mode.

- Note**
- Do not turn off the driver power while an alarm records are being cleared (=while the display is blinking). Doing so may damage the data.

8.2 Warnings

The warning types and records can be displayed on the monitor mode.

When a warning generates, the WNG output will be turned ON. The WNG output is not assigned to the output terminal at the time of shipment. Refer to p.27 "Description of I/O signals."

■ Warning list

Warning code	Warning type	Motor operation	Generation condition	Remedial action
U021	Main circuit overheat	Continue to operate	The temperature inside the driver exceeded the warning detection temperature.	<ul style="list-style-type: none"> Review the ambient temperature. Review the ventilation condition in the enclosure.
U030	Overload		A load exceeding the "overload warning level" parameter was applied to the motor.	Check the load condition.
U05c	Operation error	Stop	When the input terminal is ON, the operation signal was assigned using the "input function selection" parameter.	When assigning the operation signal, check that the input terminal to be assigned is turned OFF.

■ Warning records

Up to 9 generated warnings are saved in the RAM in order of the latest to oldest.

When clearing the warning records, perform the warning record clear on the monitor mode.

Note The warning records will be cleared by turning off the driver power.

9 Troubleshooting and remedial actions

During motor operation, the motor or driver may fail to function properly due to an improper speed setting or wiring. When the motor cannot be operated correctly, refer to the contents provided in this section and take appropriate action. If the problem persists, contact your nearest office.

- Note**
- Check the alarm message when the alarm generates.
 - I/O signals can be monitored with the monitor mode. Use to check the wiring condition of the I/O signals.

The motor does not operate.	<ul style="list-style-type: none"> ● The power supply is not connected correctly or it has become improper connection. <ul style="list-style-type: none"> ▷ Check the connections between the driver and power supply.
	<ul style="list-style-type: none"> ● The operation switch is set to the "STAND-BY" side. <ul style="list-style-type: none"> ▷ Set the operation switch to the "RUN" side.
	<ul style="list-style-type: none"> ● When operating the motor using the operation switch, the "external operation signal input" parameter is set to "ON" or "RE." <ul style="list-style-type: none"> ▷ Set the "external operation signal input" parameter to "OFF" after setting the operation switch to the STAND-BY side.
	<ul style="list-style-type: none"> ● When operating the motor using external signals, the "external operation signal input" parameter is set to "OFF." <ul style="list-style-type: none"> ▷ Set the "external operation signal input" parameter to "ON" or "RE" after turning the input operation signal OFF.
	<ul style="list-style-type: none"> ● Both the FWD input and REV input are being OFF. Both the FWD input and REV input are being ON. <ul style="list-style-type: none"> ▷ Turn either of the FWD input or REV input ON.
	<ul style="list-style-type: none"> ● An alarm is present. <ul style="list-style-type: none"> ▷ A protective function is triggered and an alarm generates. Refer to p.32 and reset the alarm after removing the cause of the alarm.
The rotation speed is not displayed.	<ul style="list-style-type: none"> ● The "panel initial view" parameter is not set to the rotation speed. <ul style="list-style-type: none"> ▷ Set the "panel initial view" parameter to the rotation speed.
The motor rotates in the direction opposite to the specified direction.	<ul style="list-style-type: none"> ● The FWD input and REV input are connected wrongly or otherwise not connected correctly. <ul style="list-style-type: none"> ▷ Check the connection of the FWD input and REV input.
	<ul style="list-style-type: none"> ● The gear ratio that the gearhead output shaft rotates in the opposite direction against the motor rotation direction is used. <ul style="list-style-type: none"> ▷ Check the operating manual supplied with the motor for the rotation direction of the gearhead output shaft.
	<ul style="list-style-type: none"> ● The rotation direction switch is set wrong. <ul style="list-style-type: none"> ▷ Check the rotation direction switch.
	<ul style="list-style-type: none"> ● When the rotation direction switch is set to REV, the "external operation signal input" parameter is set to "RE." <ul style="list-style-type: none"> ▷ Check the setting of the "external operation signal input" parameter.
The setting cannot be performed using the setting dial.	<ul style="list-style-type: none"> ● The lock function has been enabled. <ul style="list-style-type: none"> ▷ Release the lock function.
The set rotation speed is not saved.	<ul style="list-style-type: none"> ● It is not determined by pressing the setting dial. <ul style="list-style-type: none"> ▷ After setting the rotation speed, determine it by pressing the setting dial.
The motor is not reversed by the rotation direction switch.	<ul style="list-style-type: none"> ● The "external operation signal input" parameter is set to "RE." <ul style="list-style-type: none"> ▷ Check the setting of the "external operation signal input" parameter.
The rotation speed cannot be increased.	<ul style="list-style-type: none"> ● The speed upper limit has been set. <ul style="list-style-type: none"> ▷ Raise the speed upper limit.
The rotation speed cannot be decreased.	<ul style="list-style-type: none"> ● The speed lower limit has been set. <ul style="list-style-type: none"> ▷ Lower the speed lower limit.
Motor operation is unstable. Motor vibration is too great.	<ul style="list-style-type: none"> ● The motor and gearhead output shaft is misaligned with a load shaft. <ul style="list-style-type: none"> ▷ Check the coupling condition of the motor and gearhead output shaft and the load shaft.
	<ul style="list-style-type: none"> ● Effect of electrical noise. <ul style="list-style-type: none"> ▷ Check the operation only with the motor, driver and other external equipment required for operation. If an effect of noise has been confirmed, implement the following countermeasures: [Move the unit farther away from noise generation sources.] [Review the wiring.] [Change the signal cables to a shielded type.] [Install ferrite cores.]

10 Inspection

It is recommended that periodic inspections for the items listed below are conducted after each operation of the motor. If an abnormal condition is noted, discontinue any use and contact your nearest Oriental Motor sales office.

- Note**
- Do not conduct the insulation resistance measurement or dielectric strength test with the motor and driver connected. Doing so may cause damage to the product.
 - The driver uses semiconductor elements, so be extremely careful when handling them. Electrostatic discharge can damage the driver.

■ During inspection

- Are any of the mounting screws of the motor and gearhead loose?
- Are there any abnormal noises from inside of the motor or gearhead?
- Is there any misalignment between the load shaft and the motor output shaft and gearhead output shaft?
- Are there any scratches, signs of stress or loose driver connections in the cable?
- Are the openings in the driver blocked?
- Are any of the mounting screws or main power input unit of the driver loose?
- Are there any strange smells or appearances within the driver?

11 Accessories (sold separately)

■ Power supply cable

This cable is used to connect the driver to the power supply.

- For single-phase
100 VAC (with plug) *

Length [m (ft.)]	Model
1 (3.3)	CC01AC03P
2 (6.6)	CC02AC03P
3 (9.8)	CC03AC03P

- For single-phase
100-120/200-240 VAC

Length [m (ft.)]	Model
1 (3.3)	CC01AC03N
2 (6.6)	CC02AC03N
3 (9.8)	CC03AC03N

- For three-phase
200-240 VAC

Length [m (ft.)]	Model
1 (3.3)	CC01AC04N
2 (6.6)	CC02AC04N
3 (9.8)	CC03AC04N

These cables are not shielded cables. If conformance to the EMC Directive is required, refer to "12.2 Installing and wiring in compliance with EMC Directive." (p.40).

- * A plug is attached to the power supply cables for the single-phase 100 VAC type.
They can be used in Japanese domestic market only.

■ Connection cable

This cable is used to extend the wiring distance between the driver and motor. The wiring distance between the motor and driver can be extended to a maximum of 10.5 m (34.4 ft.).

The motor cables, connection cables and flexible connection cables are shielded cables which have taken measures against the electrical noise.

The connection cable for relay can be used by connecting up to 2 pieces.

- Connection cable

Length [m (ft.)]	Model
1 (3.3)	CC01BL2
2 (6.6)	CC02BL2
3 (9.8)	CC03BL2
5 (16.4)	CC05BL2
7 (23.0)	CC07BL2
10 (32.8)	CC10BL2

- Flexible connection cable

Length [m (ft.)]	Model
1 (3.3)	CC01BL2R
2 (6.6)	CC02BL2R
3 (9.8)	CC03BL2R
5 (16.4)	CC05BL2R
7 (23.0)	CC07BL2R
10 (32.8)	CC10BL2R

■ Mounting brackets for electrical circuit products

Mounting brackets convenient for installation of the driver are provided.

According to applications, the type of the mounting brackets can be selected from for DIN rail-installation type, for panel-installation type, or for conveyor guide-installation type.

- For DIN rail-installation type
Model: **MADP05-15**
- For panel-installation type
Model: **MAFP04-15**
- For conveyor guide-installation type
Model: **MAFP05V**
MAFP05H

■ Watertight and dust-resistant type Front cover

This is a cover to protect the front panel of the driver. Also, it can be used for preventing wrong operations of the front panel. The degree of protection is IP64.

Model: **PCF12-B**

About motor mounting brackets (SOL)

When the mounting bracket and motor are secured, use so that the direction of the connector for cable connection is installed upward or sideways against the installation surface. Installing the motor connector to the downward direction is not recommended since the motor connector is come into contact with the mounting bracket or installation surface.

12 Reference

12.1 Standard and CE Marking

This product is recognized by UL under the UL and CSA standards, and it is also affixed the CE Marking under the Low Voltage Directive. The driver model name represents the model that conforms to the standards.

■ UL Standards and CSA Standards

Applicable Standards

Applicable Standards	Certification Body	Standards File No.
UL 508C CSA C22.2 No.274	UL	E171462

■ Low Voltage Directive

- This product is designed and manufactured to be incorporated in equipment.
- This product cannot be used in IT power distribution systems.
- Install the product within the enclosure in order to avoid contact with hands.
- Be sure to ground the Protective Earth Terminal of the motor and driver.
- Isolate the cable for connecting between the motor and the driver, the power supply cable and other drive cables from the signal cables (CN4) by means of double insulation.

Applicable Standards

EN 61800-5-1

Installation conditions (EN Standard)

For incorporating in equipment

Overvoltage category: II

Pollution degree: 2

Protection against electric shock: Class I

■ EMC Directive

This product has received EMC compliance under the conditions specified in "Example of motor and driver installation and wiring" on p.41. The final level of conformance of your mechanical equipment to the EMC Directive will vary depending on the control system equipment used with the motor/driver, configuration of electrical parts, wiring, layout, hazard level, and the like. It therefore must be verified through conducting EMC measures on your mechanical equipment.

Applicable Standards

EMI	Emission Tests	EN 61000-6-4, EN 61800-3 C3
	Harmonics Current Test	EN 61000-3-2
	Voltage Fluctuations Test	EN 61000-3-3
EMS	Immunity Tests	EN 61000-6-2, EN 61800-3 C3

This type of PDS is not intended to be used on a low-voltage public network which supplies domestic premises; radio frequency interference is expected if used on such a network.

■ Hazardous substances

The products do not contain the substances exceeding the restriction values of RoHS Directive (2011/65/EU).

12.2 Installing and wiring in compliance with EMC Directive

This product has been designed and manufactured to be incorporated in equipment. The EMC Directive requires that your mechanical equipment in which the product is installed satisfies the applicable requirements.

The installation/wiring methods of the motor and driver explained here represent the basic methods that are effective in helping your mechanical equipment conform to the EMC Directive.

The final level of conformance of your mechanical equipment to the EMC Directive will vary depending on the control system equipment used with the motor, configuration of electrical parts, wiring, layout, hazard level, and the like. It therefore must be verified through conducting EMC measures on your mechanical equipment.

Without effective measures to suppress the electromagnetic interference (EMI) caused by the product in the surrounding control system equipment or the electromagnetic spectrum (EMS) generated by the product, the function of your mechanical equipment may be seriously affected. This product will conform to the EMC Directive if installed/wired using the methods specified below.

■ Connecting a mains filter

Install a mains filter which the customer provides, in the power line in order to prevent the noise generated within the driver from propagating outside via the AC input line. For mains filters, use the products as shown in the chart, or an equivalent.

Manufacturer	Single-phase 100-120 V Single-phase 200-240 V	Three-phase 200-240 V
SOSHIN ELECTRIC CO., LTD	HF2010A-UPF, NF2010A-UP	NFU3010C-Z1
Schaffner EMC	FN2070-10-06	FN3025HP-10-71

- Overvoltage category II applies to mains filters.
- Install the mains filter as close to the driver as possible.
- Use cable clamps and other means to secure the input and output cables firmly to the surface of the enclosure.
- Connect the ground terminal of the mains filter to the grounding point, using as thick and short a wire as possible.
- Do not place the AC input cable (AWG18 to 14: 0.75 to 2.0 mm²) parallel with the mains-filter output cable (AWG18 to 14: 0.75 to 2.0 mm²). Parallel placement will reduce mains filter effectiveness if the enclosure's internal noise is directly coupled to the power supply cable by means of stray capacitance.

■ Connecting the AC power line reactor

When inputting single-phase 200-240 V, insert a reactor (5 A, 5 mH) in the AC power line to ensure compliance with EN 61000-3-2.

■ Connecting the external power supply

Use an external power supply conforming to the EMC Directive. Use a shielded cable for wiring the external power supply over the shortest possible distance. Refer to "Wiring the power supply cable" for how to ground the shielded cable.

■ How to ground

The cable used to ground the motor, driver, mains filter and power supply cable (shielded cable) must be as thick and short to the grounding point as possible so that no potential difference is generated. Choose a large, thick and uniformly conductive surface for the grounding point. Refer to the p.12 for the recommended grounding method.

■ Wiring the power supply cable

Use a shielded cable of AWG18 to 14 (0.75 to 2.0 mm²) in diameter for the driver power supply cable and keep it as short as possible. Strip a part of the shielded cable and ground the stripped part using a metal cable clamp that contacts the stripped cable around its entire circumference, or use a drain wire to make the ground connection.

When grounding the shielded cable, connect both ends (mains filter side and power supply side) to earth to prevent a potential difference from generating in the shielded cable.

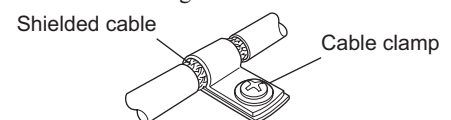

■ Ferrite core

Use a ferrite core when the total length of the connection cable is 10 m (32.8 ft.) or more. The ferrite core reduces the negative effects of external noise. Use ferrite core 7427122 (Würth Elektronik GmbH & Co.KG), ZCAT3035-1330 (TDK Corporation) or its equivalent.

Connect the ferrite cores as close as possible to the driver.

■ Notes about installation and wiring

- Connect the motor/driver and other peripheral control equipment directly to the grounding point so as to prevent a potential difference from developing between grounds.
- When relays or electromagnetic switches are used together with the system, use mains filters and CR circuits to suppress surges generated by them.
- Keep cables as short as possible without coiling and bundling extra lengths.
- Separate the cable for connecting between the motor and the driver, the power supply cable and other drive cables from the signal cables, and wire with providing a minimum clearance of 100 mm (3.94 in.) between them. If they must cross, do so at a right angle. Place the AC input cable and output cable of a mains filter separately from each other.
- Use a dedicated connection cable (sold separately) for the connection between the connector type motor and the driver. Use an accessory connection cable when extending the wiring distance between the motor and the driver. The EMC measures are conducted using the Oriental Motor connection cable.

■ Example of motor and driver installation and wiring

The figure shows the connector type.

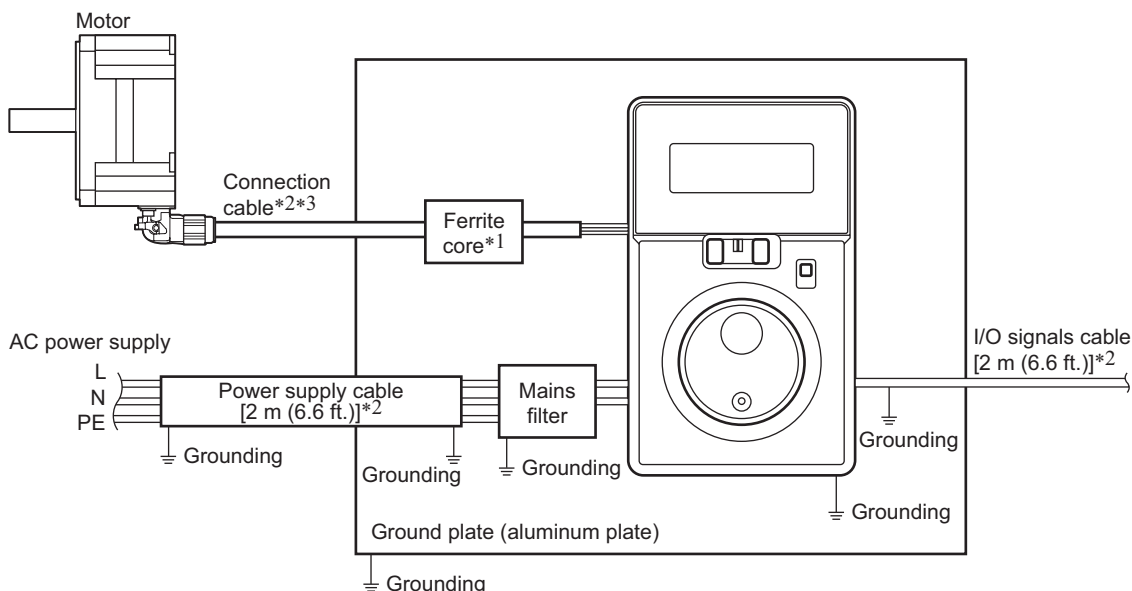

*1 Use a ferrite core when the total length of the connection cable is 10 m (32.8 ft.) or more. (Connector type only)

*2 Shielded cable

*3 Connect the ground terminal of the connection cable to that of the driver.
Refer to p.12 for details.

■ Precautions about static electricity

Static electricity may cause the driver to malfunction or suffer damaged.

Be sure to ground the motor and driver to prevent them from being damaged by static electricity.

Except when operating the setting dial, potentiometer or switches on the driver front panel, do not come to close or touch the driver while the driver power is ON. To change the settings of driver acceleration/deceleration time potentiometer, be sure to use an insulated screwdriver.

12.3 Specifications

- □ in the motor model name indicates a code or number representing the gear ratio, the motor type, or the motor shaft type.
- The value in a state where the gearhead is not combined is described in each specification for the "rated torque," "instantaneous peak torque," "rated rotation speed" and "speed control range."

Model	Motor	BLM230-□□ BLM230HP-□□		BLM260-□□ BLM260HP-□□ BLM460-□□ BLM460SHP-□□	
	Driver	BMUD30-A2	BMUD30-C2	BMUD60-A2	BMUD60-C2
Rated output power (Continuous)		30 W		60 W	
Power supply input	Rated voltage	Single-phase 100-120 V	Single-phase 200-240 V Three-phase 200-240 V	Single-phase 100-120 V	Single-phase 200-240 V Three-phase 200-240 V
	Permissible voltage range	-15 to +10%			
	Rated frequency	50/60 Hz			
	Permissible frequency range	±5%			
	Rated input current	1.2 A	Single-phase: 0.7 A Three-phase: 0.38 A	1.7 A	Single-phase: 1.0 A Three-phase: 0.52 A
	Maximum input current	2.0 A	Single-phase: 1.2 A Three-phase: 0.75 A	3.3 A	Single-phase: 1.9 A Three-phase: 1.1 A
Rated torque		0.096 N·m (13.6 oz-in)		0.191 N·m (27 oz-in)	
Instantaneous peak torque		0.144 N·m (20 oz-in) [80 to 2000 r/min]		0.287 N·m (41 oz-in) [80 to 2000 r/min]	
Rated rotation speed		3000 r/min			
Speed control range		80 to 4000 r/min *			

* There are products, which maximum rotation speed is 3600 r/min, depending on the gearhead type.
Check the operating manual supplied with the motor.

Model	Motor	BLM5120-□□ BLM5120HP-□□ BLM5120HPK-□□□□	
	Driver	BMUD120-A2	BMUD120-C2
Rated output power (Continuous)		120 W	
Power supply input	Rated voltage	Single-phase 100-120 V	Single-phase 200-240 V Three-phase 200-240 V
	Permissible voltage range	-15 to +10%	
	Rated frequency	50/60 Hz	
	Permissible frequency range	±5%	
	Rated input current	3.3 A	Single-phase: 2.0 A Three-phase: 1.1 A
	Maximum input current	6.8 A	Single-phase: 4.1 A Three-phase: 2.0 A
Rated torque		0.382 N·m (54 oz-in)	
Instantaneous peak torque		0.573 N·m (81 oz-in) [80 to 2000 r/min]	
Rated rotation speed		3000 r/min	
Speed control range		80 to 4000 r/min *	

* There are products, which maximum rotation speed is 3600 r/min, depending on the gearhead type.
Check the operating manual supplied with the motor.

General specifications

Operation environment	Ambient temperature	0 to +40 °C [+32 to +104 °F] (non-freezing)
	Ambient Humidity	85% or less (non-condensing)
	Altitude	Up to 1000 m (3300 ft.) above sea level
	Surrounding atmosphere	No corrosive gas or dust. Cannot be used in radioactive materials, magnetic field, vacuum or other special environment. Details about the installation location are described on p.8.
	Vibration	Not subject to continuous vibrations or excessive impact In conformance with JIS C 60068-2-6 "Sine-wave vibration test method" Frequency range: 10 to 55 Hz Pulsating amplitude: 0.15 mm (0.006 in.) Sweep direction: 3 directions (X, Y, Z) Number of sweeps: 20 times
Storage environment Shipping environment	Ambient temperature	Driver: -25 to +70 °C [-13 to +158 °F] (non-freezing)
	Ambient Humidity	85% or less (non-condensing)
	Altitude	Up to 3000 m (10000 ft.) above sea level
	Surrounding atmosphere	No corrosive gas, dust, water or oil. Cannot be used in radioactive materials, magnetic field, vacuum or other special environment.
Degree of protection		Driver: IP20

12.4 Pin assignment

The following figures represent as the view from the direction of the lead wires side of the connection cable or the motor cable.

• Power connector (White)

Pin No.	Color	Lead wire
1	Blue	AWG18
2	-	-
3	-	Drain AWG24 or equivalent
4	Purple	AWG18
5	Gray	
6	-	-

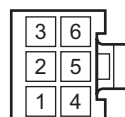

Housing: 5557-06R-210 (molex)
Terminal: 5556T (molex)

• Sensor connector (Black)

Pin No.	Color	Lead wire
A3	-	AWG26
A2	Green	
A1	Yellow	
B3	Brown	
B2	Red	
B1	Orange	

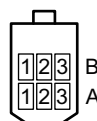

Housing: J11DF-06V-KY
(J.S.T. Mfg Co., Ltd.)
Terminal: SF1F-002GC-P0.6
(J.S.T. Mfg Co., Ltd.)

- Unauthorized reproduction or copying of all or part of this manual is prohibited.
If a new copy is required to replace an original manual that has been damaged or lost, please contact your nearest Oriental Motor branch or sales office.
- Oriental Motor shall not be liable whatsoever for any problems relating to industrial property rights arising from use of any information, circuit, equipment or device provided or referenced in this manual.
- Characteristics, specifications and dimensions are subject to change without notice.
- While we make every effort to offer accurate information in the manual, we welcome your input. Should you find unclear descriptions, errors or omissions, please contact the nearest office.
- **Orientalmotor** is a registered trademark or trademark of Oriental Motor Co., Ltd., in Japan and other countries.
Other product names and company names mentioned in this manual may be registered trademarks or trademarks of their respective companies and are hereby acknowledged. The third-party products mentioned in this manual are recommended products, and references to their names shall not be construed as any form of performance guarantee. Oriental Motor is not liable whatsoever for the performance of these third-party products.

© Copyright ORIENTAL MOTOR CO., LTD. 2016

- Please contact your nearest Oriental Motor office for further information.

ORIENTAL MOTOR U.S.A. CORP.
Technical Support Tel:(800)468-3982
8:30 A.M. to 5:00 P.M., P.S.T. (M-F)
7:30 A.M. to 5:00 P.M., C.S.T. (M-F)
www.orientalmotor.com

ORIENTAL MOTOR DO BRASIL LTDA.
Tel:+55-11-3266-6018
www.orientalmotor.com.br

ORIENTAL MOTOR (EUROPA) GmbH
Schiessstraße 74, 40549 Düsseldorf, Germany
Technical Support Tel:00 800/22 55 66 22
www.orientalmotor.de

ORIENTAL MOTOR (UK) LTD.
Tel:01256-347090
www.oriental-motor.co.uk

ORIENTAL MOTOR (FRANCE) SARL
Tel:01 47 86 97 50
www.orientalmotor.fr

ORIENTAL MOTOR ITALIA s.r.l.
Tel:02-93906346
www.orientalmotor.it

ORIENTAL MOTOR ASIA PACIFIC PTE. LTD.
Singapore
Tel:1800-8420280
www.orientalmotor.com.sg

ORIENTAL MOTOR (MALAYSIA) SDN. BHD.
Tel:1800-806161
www.orientalmotor.com.my

ORIENTAL MOTOR (THAILAND) CO., LTD.
Tel:1800-888-881
www.orientalmotor.co.th

ORIENTAL MOTOR (INDIA) PVT. LTD.
Tel:+91-80-41125586
www.orientalmotor.co.in

TAIWAN ORIENTAL MOTOR CO., LTD.
Tel:0800-060708
www.orientalmotor.com.tw

SHANGHAI ORIENTAL MOTOR CO., LTD.
Tel:400-820-6516
www.orientalmotor.com.cn

INA ORIENTAL MOTOR CO., LTD.
Korea
Tel:080-777-2042
www.inaom.co.kr

ORIENTAL MOTOR CO., LTD.
Hong Kong Branch
Tel:+852-2427-9800

ORIENTAL MOTOR CO., LTD.
4-8-1 Higashiueno, Taito-ku, Tokyo
110-8536 Japan
Tel:03-6744-0361
www.orientalmotor.co.jp